



Zixi Broadcaster User Guide

Software Version 16
Document Version - DOC16-83-0039
Copyright © Zixi 2023
All Rights Reserved

Legal Notice

This document contains proprietary and confidential material of Zixi LLC. Any unauthorized reproduction, use, or disclosure of this material, or any part thereof, is strictly prohibited. This document is solely for the use of Zixi employees and authorized Zixi customers.

The error recovery techniques implemented in the Zixi protocol are protected under U.S. patent 11,546,615.

The material furnished in this document is believed to be accurate and reliable. However, no responsibility is assumed by Zixi LLC. for the use of this document or any material included herein. Zixi LLC. reserves the right to make changes to this document or any material included herein at any time and without notice.

For more information visit: www.zixi.com.

Copyright © Zixi 2023 Waltham, MA U.S.A.

All Rights Reserved.

** See back for additional licensing information*

Table of Contents

Legal Notice.....	2
Introduction to Zixi Broadcaster	10
Zixi Software-Defined Video Platform (SDVP)	12
SDVP Architecture.....	14
Zixi Transport Stream Protocol	14
Supported Protocols	15
Transcoding Options	17
Recording Options	17
Multicast Options.....	17
Adaptive Options	17
VOD Options	17
Latency Considerations.....	17
Billing Codes.....	18
Logging in to the Broadcaster	19
Activating Your License	20
Online Activation (License Key)	20
Offline Activation (License File)	20
Reloading the License	21
Upgrading the Product Version (Linux)	21
Viewing Status.....	23
General Status.....	23
Network Status	24
Viewing Current License Information	24
Metered License Monitoring	24
License Status Screen.....	26
Machine Information	27
Operating System Information	28
Network Cards (Linux only).....	28
Network Test.....	29

Legal Notice

Zixi Software-Defined Video Platform (SDVP)

Installing the Zixi Video Acceleration Proxy.....	30
Using the Zixi Video Acceleration Proxy for previewing a stream.....	33
Broadcaster Inputs.....	35
Adding Input Streams	36
Adding Push Streams	36
Adding Pull Streams	42
Adding UDP Streams.....	48
Adding Delayed Streams.....	54
Adding File Streams	56
Adding RTMP Streams	58
Adding RTSP Streams	64
Adding HLS Streams	69
Adding TS over HTTP (Pull) Streams	74
Adding TS over HTTP (Push) Streams.....	78
Adding SRT Streams	82
Adding SRT Client Streams.....	88
Adding RIST Streams	92
Adding NDI Streams	99
Adding WebRTC Streams	103
Adding File over HTTP Streams.....	109
Adding Multiplex Streams.....	113
Viewing Existing Input Streams.....	118
Viewing Stream Statistics.....	119
Searching for Input Streams	122
Broadcaster Actions on Input Streams	122
Stopping/Starting the Input Stream	122
Editing Input Settings or Duplicating Input Streams.....	122
Deleting Input Streams from Broadcaster	123
Recording the Input Stream.....	123
Adding TR101 Analysis to the Input Stream	124
Transcoding an Input Stream.....	125
Add Output	132

Legal Notice

Zixi Software-Defined Video Platform (SDVP)

Playing Input Streams with Players.....	133
Viewing Traceroutes	136
Broadcaster Actions on Multiple Inputs	136
Starting and Stopping Multiple Input Streams	136
Toggle Input Stream Records.....	137
Deleting Multiple Input Streams.....	137
Saving Multiple Input Streams.....	137
Resetting Stats for Multiple Input Streams	137
Creating a Failover Group	138
Encrypting an Input Stream in Zixi Broadcaster	140
Decrypting an Input Stream in Zixi Broadcaster	141
Demuxing an MPTS Stream	142
Viewing TR101 Analysis	144
Stream Information Statistics Panel	145
P1/P2 Errors	149
Content Analysis	150
Enabling Content Analysis.....	151
Broadcaster Outputs.....	152
Adding Outputs	153
Adding UDP Outputs	153
Adding RTMP and RTMPS Outputs	157
Adding Pull Outputs	159
Adding Push Outputs	161
Adding TCP Outputs	165
Adding HTTP Push Outputs.....	167
Adding AWS Outputs	170
Adding SRT Outputs	173
Adding SRT Client Outputs.....	175
Adding RIST Outputs	177
Viewing Existing Outputs	182
Stats Pane.....	183
Searching for Output Streams	185

Legal Notice

Zixi Software-Defined Video Platform (SDVP)

Performing Actions on Output Streams.....	185
Deleting Output Streams from Broadcaster	185
Switching Input	185
Viewing Traceroutes	186
Performing Actions on Multiple Outputs	187
Delete Marked Individual and Multiple Outgoing Stream	187
Start and Stop Marked Individual and Multiple Outgoing Streams	187
Save Marked Individual and Multiple Outgoing Streams	187
Reset Stats for Individual and Multiple Outgoing Streams	188
Viewing Traceroutes	188
Using Output Templates.....	188
Adding SRT Client Outputs.....	193
Broadcaster Network Bonding.....	196
Using Network Bonding for Hitless Failover	196
Broadcaster Output with Network Bonding.....	197
Adaptive Groups	198
Creating New Adaptive Groups	198
Adding Streams to Existing Adaptive Groups	201
Adaptive Groups Templates	202
Performing Actions on Adaptive Groups	205
Stopping/Starting an Adaptive Group	205
Editing an Existing Adaptive Group.....	206
Deleting and Adaptive Group	206
Play Dash.....	206
Play fMP4	207
Play HLS.....	208
Set Preroll.....	209
VOD (Video on Demand).....	211
VOD Activation.....	211
VOD Files Location	211
Changing the Files folder location	213
Adding Files to VOD	213

Legal Notice

Zixi Software-Defined Video Platform (SDVP)

Playing back VOD content.....	214
Indexing VOD content.....	215
Accelerated File Transfer	216
File Transfer Configuration	216
File Transfer Settings.....	216
Uploading Files for File Transfer	217
Downloading Files.....	219
Downloading Files using Zixi Protocol	219
Downloading Files using HTTP Protocol	220
Generating Accelerated URLs	220
Creating a New Folder	221
Renaming a File/Folder	222
Deleting an Existing File/Folder	223
Transcoder	224
Creating New Profiles	224
Transcoding an Input Stream.....	231
Transcoding Templates.....	236
Hardware Acceleration Checklist.....	243
Server Settings	245
General.....	245
Network	250
Time	252
Live Protocols.....	253
Multicast Pull Outputs	256
File Transfer & VOD.....	256
Cluster	259
Zen Master	262
SSH Connections	264
Authorization	266
Logging	268
ASI	269
Reversing the directions of the ports	270

Legal Notice

Zixi Software-Defined Video Platform (SDVP)

Threads.....	271
SNMP (Linux Only) (Deprecated)	272
Transcoder	274
Enabling PSNR in x264	274
SCTE35 Report.....	274
Billing Codes.....	275
Viewing Events Log	276
Using the Matrix.....	277
Connecting Input to Output.....	277
Disconnecting Output from Input.....	278
Matrix Interface Elements	278
Changing Matrix View	279
Searching for Specific Streams.....	279
Preview Thumbnail Elements	279
Viewing Stream Details	281
Configuring SNMP (Deprecated).....	282
Activating SNMP	282
Configuring SNMP Settings	282
Viewing MIB Information.....	285
SNMP Alerts/Notifications	285
Configuring Hitless Failover	287
Configuring HTTPS.....	289
Obtaining a CA-signed Certificate.....	289
Creating a Self-signed Certificate.....	289
Uploading the Certificate and Private Key.....	290
Configuring NDI Streams.....	291
NDI Stream Discovery	291
OS Support	293
Enabling Multicast Network Support.....	293
NDI config file location.....	293
Specifying the NDI Discovery Server	293
Configuring Transcoding Profiles for NDI Sources.....	294

Legal Notice

Zixi Software-Defined Video Platform (SDVP)

Adding an NDI Input to Zixi Broadcaster	294
Creating an NDI Output	300
Configuring WebRTC Streams.....	305
Video and Audio Codec Support Options	305
Creating Transcoding Profiles for WebRTC.....	308
Creating a Video Profile for “Single Version” Transcoding.....	308
Creating an Audio Profile for “Single Version” Transcoding.....	308
Creating a Video Profile for “Multiple Version” Transcoding.....	309
Creating an Audio Profile for “Multiple Version” Transcoding	310
Creating a WebRTC Output.....	310
Playing and input stream with WebRTC player	312
Configuring MultiPath TCP.....	313
MultiPath Modes	313
MultiPath TCP Setup	315
Using an External Storage	316

Introduction to Zixi Broadcaster

The Zixi Broadcaster is the central component in the Zixi Software-Defined Video Platform (SDVP). Zixi Broadcaster takes video streams from Zixi Edge Compute, and can process the stream, enabling transcoding, transmuxing, recording, and distribution in multiple bit rates and protocols to any device anywhere. The Zixi Broadcaster is an intelligent and versatile video distribution component that may reside on premise at a customers' site, on the customer's cloud, or offered by Zixi as a cloud service.

Zixi Broadcaster offers the following features:

- **Robust content delivery over IP** - communicates with Zixi Edge Compute over UDP-based, video-optimized protocols on private and public IP networks for maximal quality at a predictable latency
- **Adaptive Bit Rate** - Dynamically adjusts stream rate to adapt to changing network conditions, using unicast or multicast, to meet specific application requirements
- **Transcoding** - transcodes to a variety of different profiles and bit rates
- **Format conversion** – supports Internet protocols: HLS/MPEG-DASH/RTMP/FLV/MPEG-TS over HTTP
- **Recording** - store streams as MPEG-TS files.
- **Time-shifting** – records the stream to delay its broadcasting
- **Secure and rapid file transfer** – accelerated and secure file transfers delivered at wire speed and accelerated HTTP delivery including optimized playback of HLS over UDP.
- **VOD** - stored files can be accessed on demand in multiple formats.
- **Clustering and load balancing** – supports cluster architectures to provide continuous uptime.
- **Transport Stream Analyzer** – MPEG-TS ETSI TR 101-290 analyzer (priorities 1 and 2)
- **Content Analysis** - analysis of the stream's audio and video content, including audio levels, audio silence detection, frozen video detection, and more.
- **Monitoring** - captures network and content specific statistical information in real-time.
- **Supports many to many and any to any** - gateway platform between UDP (unicast/multicast), Zixi protected stream (unicast/multicast), RTMP, or other supported formats.
- **Network bonding with hit-less fail-over** – reunites divided streams coming from multiple network channels into a single stream, enabling simultaneous load balancing between multiple networks and ensuring high availability of the stream.
- **Hitless failover** - hitless failover for inputs enables uninterrupted streaming when switching from one source to another. Zixi's new hitless failover feature is based on the SMPTE 2022-7 standard, which specifies “seamless” or hitless failover between binary-identical streams with synchronized RTP headers.
- **IFB Support** - a monitoring and cueing system for one-way communication from the director or assistant director to on-air talent or a remote location. IFB support has been

implemented in Zixi Broadcaster Pull and UDP outputs, allowing the decoder with a Zixi Edge Compute to send audio back to the encoder with a Zixi Edge Compute.

- **AES stream encryption and decryption** - UDP, File and RTMP input streams can be encrypted by Zixi Broadcaster using a fixed key (AES 128, AES 192, AES 256), which can be entered into the input settings or automatically generated. Zixi Broadcaster can also decrypt contribution streams using a matching key, or securely forward encrypted streams, without being able to see or analyze the traffic.
- **MPTS demuxing** - MPTS streams can be demuxed into single SPTS input streams for specific programs.
- **SCTE-35** - SCTE-35 markers found in the source input will be used to segment the stream and the #EXT-X-CUE-IN/#EXT-X-CUE-OUT tags will be added to the manifest.
- **Low-latency HLS** - Zixi Broadcaster supports low latency HLS delivery using chunked transfer encoding, which starts sending an HTTP response as chunks of data when they are ready before the complete response is available. Chunked transfer encoding can be use with transport stream (TS) segments and with fragmented MP4 (fMP4), which is also called Common Media Application Format (CMAF). For low latency HLS and DASH, Zixi Broadcaster must be used as an origin server.

Zixi Software-Defined Video Platform (SDVP)

Zixi's proprietary Software-Defined Video Platform or SDVP is the tight integration of four components that enable broadcast-quality live video workflows to be intelligently and centrally provisioned, deployed, managed, and monitored using software and integrated devices, regardless of the underlying network infrastructure. Employed by traditional broadcasters, OTT broadcast services, service providers to source, manage, and distribute live events and 24/7 live linear channels over any IP network, protocol, cloud provider, and/or edge device.

- **Protocols & Containers** – The SDVP accepts over 17 industry protocols and containers, advancing the market leading Zixi protocol while adding additional value to tangential offerings from other vendors, standards, and open-sourced initiatives. Most customers rely on the Zixi protocol for transport as it is congestion and network-aware and can dynamically adjust to varying network conditions and employ forward error correction techniques for error-free video delivery.
- **Video Solutions Stack** – Zixi's Video Solutions Stack provides essential tools and core media processing functions for broadcast-quality transport that corrects for packet loss and jitter. Patented Hitless Failover techniques provide 99.9999%+ reliable transport between sources and receivers. The Video Solutions Stack also provides broadcasters with enhanced tools to streamline workflows including protocol switching, analytics, live 4K transcoding and repackaging, recording, time shifted delivery, and auto-slating.
- **Intelligent Data Platform** – Zixi is constantly incorporating analytics, event correlation, AI and Machine Learning tools in its platform to aggregate a user's historical and real-time metadata and present it back to them to help better predict downtime, content quality, trends, and more in the form of alerts, notifications, and background monitoring.
- **ZEN Master** – With Zixi's ZEN Master control plane, cost-effectively manage and monitor complex deployments at scale and configure and orchestrate live broadcast channels across protocols and the Zixi Enabled Network. ZEN Master allows for control of the edge, network, and cloud with full telemetry visualization of network streams. It offers essential monitoring and management tools like workflow visualization, alerting, history, automation, scheduling, reporting, and root cause analysis across complex media supply chains.

Seamless Protocol Switching Between 17 Protocols

Once users adopt the SDVP and install the software components, they can choose to send or receive live video streams using the Zixi protocol or one of the 16 supported protocols. With the SDVP, users can conduct protocol switching, handle up to 5Gb+ streams in 4K and now 8K video, and change stream parameters without stopping the stream. SDVP allows for high availability with high redundancy and can run on premise or on any cloud.

Hitless Failover, Analytics, and Bonding

Users can take advantage of its Video Solutions Stack capabilities such as analytics, hitless failover and bonding across diverse ISPs to ensure high reliability and encrypt content with AES 256 encryption and DTLS for best-in-class security. The Video Solutions Stack's unique patented hitless failover techniques ensure reliability, and its robust analytics suite provides atomic-level telemetry on stream health that allows users to address any issues impacting QoS before the consumer's QoE is affected. The analytics solution employs machine learning techniques to provide a real-time estimated PSNR (ePSNR) with no reference video required, helping the user determine if content providers are meeting SLAs for contribution stream quality.

ZEN Master Control Plane

ZEN Master integration allows remote access to the UIs of Zixi-integrated devices and software across the Zixi Enabled Network for optimal monitoring and control from one centralized control plane. With the ZEN Master control plane, users have extensive visibility into and control over workflows that go across Zixi-enabled multi-party supply chains, with the ability to leverage alerting, extensive history graphs, automated toolsets, and scheduling and reporting capabilities that abstract complexity to reduce engineering requirements and allow media organizations to leverage operational resources, providing democratized access with geographic agility.

SDVP Architecture

The Zixi SDVP architecture shows how a live linear broadcast or event is ingested through Zixi Edge Compute (ZEC) or a Zixi embedded device at acquisition. ZEC encapsulates the stream in the Zixi transport protocol and delivers point to point or point to multi-point over standard IP connections to Zixi Broadcaster (ZB). Zixi Broadcaster can be deployed on premise or in the cloud with the ability to monitor streams anywhere along the path. For management, processing and larger scale distribution capabilities, Zixi can support complex production workflows for live events, including transcoding, recording, and more, all in a clustered environment that supports reliability and scalability. The stream is distributed through a CDN, OTT, or endpoint device, running Zixi to any device.

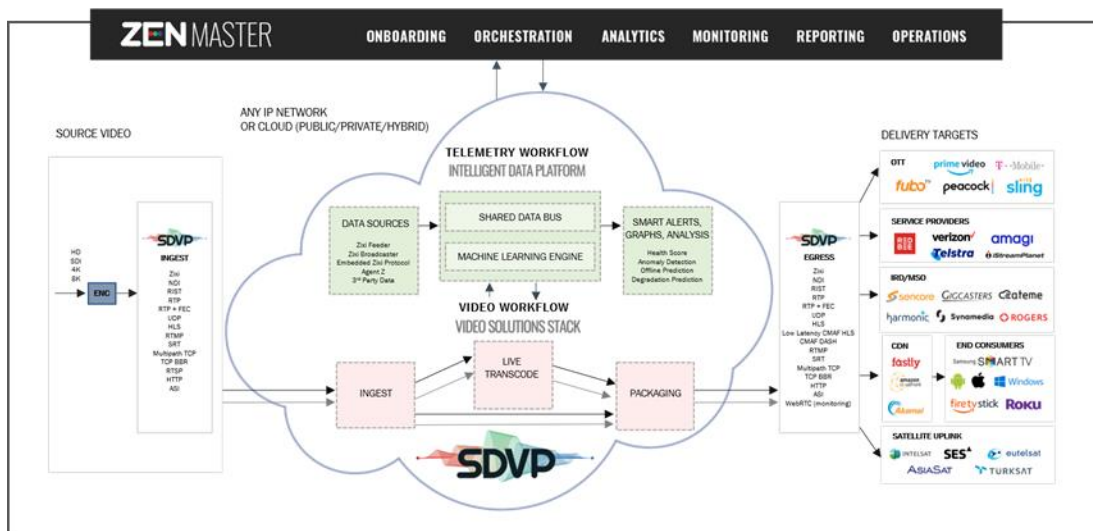

Zixi Transport Stream Protocol

Zixi’s transport stream protocol is a content and network-aware protocol that dynamically adjusts to varying network conditions and employs error correction techniques for error-free video streaming over IP. With minimum overhead to physical bandwidth, this dynamic mechanism provides low end-to-end latency, removes jitter, recovers and re-orders packets, smooths video delivery and regenerates video to its original form, all in real-time. Zixi delivers outstanding performance (at low predictable latency), superior reliability (no packet loss) and broadcast-grade video quality (SD, HD, and UHD) with no tradeoffs to delay, resolution or stutter.

Streaming from one Zixi-enabled device/server to another Zixi-enabled device/server protects the stream from quality degradations along the path. It enables the streaming of high-quality video over any distance, while overcoming the varying network conditions of the public Internet, where the amount of network errors, packet loss, jitter and out-of-order packets fluctuate "every second".

Supported Protocols

The Zixi transport stream protocol can be also deployed on part of the path. For example, from ZEC to a Zixi Broadcaster (Zixi protected path) and on to the end user through UDP or RTMP. In this case, the path that has challenging conditions (e.g., long distance or unstable wireless conditions) will be protected by Zixi and then delivered on to the end-user on a standard UDP or RTMP protocol.

Zixi's transport stream technology includes the following features for ultimate quality and security:

- Network sensing
- Dynamic de-jitter
- MPEG specific optimizations
- Z-ARQ error recovery
- Z-FEC - Dynamic content aware forward error correction
- Active multi-path error recovery
- Adaptive bitrate over UDP, unicast or multicast
- Rate control and congestion avoidance
- 256-bit AES transport encryption

Supported Protocols

Input:

- Zixi protected transport
- MPEG-TS over UDP and/or RTP with SMPTE-2022 and/or
- RTMP pull from CDNs and/or other sources
- RTMP push
- RTMPS
- RTSP input
- RIST (TR-06-1)
- NDI
- Transport stream files from local file system
- SRT (configured via Zen Master or Zixi API)

Supported Protocols

Output:

- Zixi protected transport
- MPEG-TS over UDP and/or RTP with SMPTE-2022 and/or RIST (TR-06-1)
- RTMP and RTMPS push to CDNs and/or other media servers;
- Apple HTTP Live Streaming (HLS)
- Adobe HTTP Dynamic Streaming (HDS)
- FLV over HTTP (HTTP pseudo-streaming)
- MPEG-DASH (DASH264 profile)
- SHOUTcast
- NDI
- Transport stream files to local file system
- Re-multiplex output streams to strict CBR for extensive compatibility with Integrated Receiver- Decoders (IRDs)
- SRT (configured via Zen Master or Zixi API)

Transcoding Options

Zixi Broadcaster can transcode a single input stream using multiple profiles. The transcoder supports the following options:

- Video Decoding – MPEG2, H.264/AVC, H.265/HEVC, Raw
- Video Encoding – MPEG2, H.264/AVC, H.265/HEVC, Raw
- Audio Decoding – AAC, MPEG-1 Audio Layer I / II / III, MPEG-2 Audio Layer I / II / III, AC-3 (Dolby Digital), Opus.



For AC-3, which can contain up to six discrete channels of sound, the transcoder only supports the left and right channels and will ignore the other channels.

- Audio Encoding – AAC, AAC-HE (High Efficiency) and AAC-HEv2; Pass through (no encoding) – any audio codec (MPEG1/2 / AAC / AC-3, E-AC-3 (Dolby Digital Plus), Opus.



Transcoding is not currently supported in ARM builds of Zixi Broadcaster.

Recording Options

Live stream inputs can be stored as MPEG-TS files to a local disk drive or mounted drive.

Multicast Options

Multicast streams can be received or be sent by the Zixi Broadcaster. Zixi Broadcaster serves as a gateway between Unicast and Multicast streams, while allowing reliable streaming over multicast.

Adaptive Options

Zixi Broadcaster can create an adaptive group, subsequently editing, recording, or playing it in conjunction with DASH, HLS, HDS or Zixi. You can also set a Pre-roll video/screen that will be played before the live streaming begins.

VOD Options

Zixi Broadcaster supports VOD (Video on Demand) playback of stored files in multiple formats such as TS, MP4, HLS, FLV.

Latency Considerations

Latency defines the delay in which the video stream will be delivered to the endpoint. This delay is essentially a buffer that is used for additional processing, thereby improving the quality

Billing Codes

of video stream. The latency should be considered based on the importance of immediacy. For example, if the video requires interaction (e.g., between a reporter in the field and an anchor in the studio), the latency should be set to a minimum so that the interaction does not suffer from any delay.

Latency can vary from tens of milliseconds to several seconds.

Zixi protocol can start providing benefit from one frame (30ms), while increasing the latency will provide more robustness for the error-recovery.

Billing Codes

Billing codes are used to identify and differentiate traffic on a Zixi Broadcaster. A billing code can be added to Sources, which represent inputs to a Broadcaster, and to Targets, which represent outputs from a Broadcaster. When a billing code is added to a Source or Target, Zixi can track the traffic on that Broadcaster input or output separately from other inputs and outputs on the same Broadcaster.

Typical use-cases for using billing codes are:

- **Differentiating Between Clients** - If you are receiving video content from different contributing clients or sending video content to multiple external organizations, you can designate distinct billing codes for each of your clients. You can then assign the client's billing code to each Source or Target associated with that client. Your organization will then be able to bill each of their clients according to their usage.
- **Charging only for Billable Usage** - When Zixi traffic is sent between distinct organizations, situations may arise in which the usage of only one of those organizations is billable. For example, if the contributor is using a Zixi Broadcaster to send outputs as if it were ZEC, then only the receiving organization should be billed for that traffic. In that case, the receiving organization can request a billing code and assign it to their Targets. They can then ask the contributor to assign the identical billing code to each of the Sources that they are sending. In this way, Zixi will know to bill only the organization that is receiving the traffic.

Billing codes are created by Zixi personnel on the Zixi Customer Portal for a particular organization. Zixi can create multiple Billing codes for an organization, enabling them to apply different codes to different traffic. All billing codes are password protected. If you would like to use billing codes in your workflows, please discuss it with your Zixi representative.



Adding a billing code to a stream will not restart the stream.

Logging in to the Broadcaster

➔ To log in to Zixi Broadcaster:

1. In your web browser, navigate to <http://localhost:4444>.
A user authentication window opens.
2. In the **User Name** field, enter '**admin**'.
3. In the **Password** field, enter '**1234**'.
4. Click **OK**.
The Broadcaster UI opens on the **Status** page.

Activating Your License

In order to start using Zixi Broadcaster, first activate your license. Zixi Broadcaster and its optional features are activated by license files. Before using Zixi Broadcaster, and when adding optional features, **activate** the appropriate license.

Online Activation (License Key)

The following procedure requires connectivity to the Internet. If you are not able to connect, you can activate the Broadcaster using the procedure described in [Offline Activation \(License File\)](#).

➔ To Activate the License online using a License Key:

1. In the **Status** page of the Zixi Broadcaster UI, click **Options** in the menu bar. The drop-down menu is displayed.

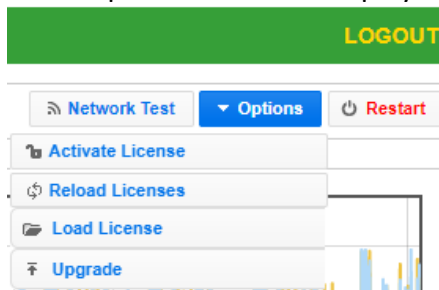

5. Click **Activate License**. The **Activate License** window appears.

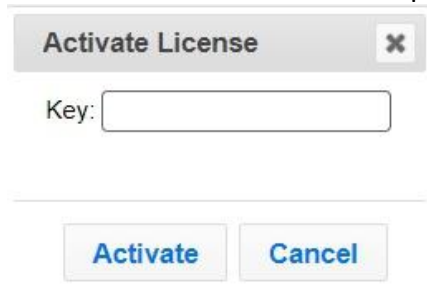

6. In the **Key** field, enter your Activation Key.
7. Click **Activate**. The Zixi Broadcaster is enabled.

Offline Activation (License File)

If you want to activate your license without an internet connection, you can upload a License File. To obtain a license file, please contact *Zixi Support* at support@zixi.com.

Activating Your License

Reloading the License

➔ To Load the License File:

1. In the **Status** page of the Zixi Broadcaster UI, click **Options** in the menu bar. The drop-down menu is displayed.

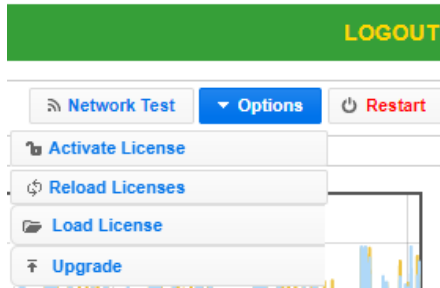

2. Click **Load License**.
The directory of the local drive opens.
3. Navigate to the License File and click **Open**.
A prompt window instructs you to Reload the license to activate the license.
4. Click again on **Options** and select **Reload Licenses** from the dropdown menu.
The Zixi Broadcaster is enabled.

Reloading the License

In the event that your license expires, you must re-enter a new Zixi license key.

➔ To reload the license:

1. In the **Status** page of the Zixi Broadcaster UI, click **Options** in the menu bar. The drop-down menu is displayed.

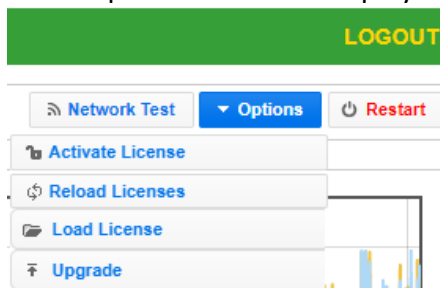

2. Click **Reload License**.
The Zixi Broadcaster is enabled.

Upgrading the Product Version (Linux)

When a new version of Zixi Broadcaster becomes available, you will receive a new installation archive file (.tar.gz file) from your Zixi representative to upgrade your Zixi Broadcaster software. It is recommended to perform the installation within a "maintenance window" and notify end users that the streaming will be momentarily interrupted. The upgrade process may last a few minutes after which the streams will be automatically resumed.

Activating Your License

Upgrading the Product Version (Linux)



Downgrading from this release to previous versions will no longer be possible through the web UI. Downgrading is still possible via the normal software installation mechanisms.

➔ To upgrade the version:

1. In the **Status** page of the Zixi Broadcaster UI, click **Options** in the menu bar. The drop-down menu is displayed.

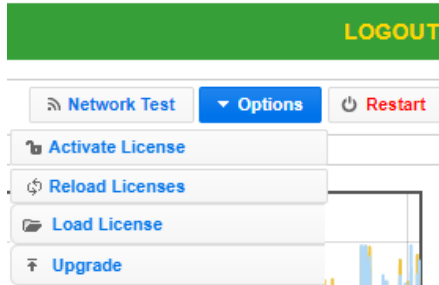

2. Click **Upgrade**.
3. Select the relevant installation archive file (.tar.gz file) and click **Open**. The installation process will begin. The process may take up to a few minutes. During the process, the streams and the management UI will not be available. After the upgrade, all streams will be automatically resumed.

Viewing Status

The Status screen displays aggregated statistics on all the input and output streams and a graph representing the network utilization of active streams over time.

➔ To View the Status of the Streams:

In the Zixi Broadcaster **Status** page, the **General** area, **Network Status** area, **License Information** area, **Machine Information** area and **Operating System** area are displayed.

General Status

General	
ID	The Zixi Broadcaster ID number
Host ID	Displays the ID of Zixi Broadcaster host.
Start Time	Displays the time that the Zixi Broadcast began to actively stream content.
Up Time	The duration of time that the broadcast is running.
Inputs	The number of current active inputs
Outputs	The number of current active outputs
Remote In [kbps]	The current aggregate input bitrate from remote sources – Zixi Push/Pull (in Kbps)
Local In [kbps]	The current aggregate input bitrate from local sources – UDP streams (in Kbps)
Remote Out [kbps]	The current aggregate output bitrate to remote destinations (in Kbps)
Local Out [kbps]	The current aggregate output bitrate to local destinations (in Kbps)
HTTP Out [kbps]	The current aggregate output bitrate for HTTP streams - FLV/RTMP/HLS/ MPEG-TS over HTTP (in Kbps)
Kilobytes Sent	The cumulative traffic transmitted (in Kbps)
Kilobytes Received	The cumulative traffic received (in Kbps)
Kilobytes Transcoded	The cumulative traffic that has been transcoded (in Kbps)
RTMP Server	Active – the RTMP server is enabled (See Settings > Live Protocols > RTMP Server section) Off – the RTMP server is disabled

Viewing Status

Network Status

Network Status

The network status graph displays the total input/output bitrate during the last hour. The changes in the amplitude of both the input (gold) and output (blue) presented in 10-minute intervals.

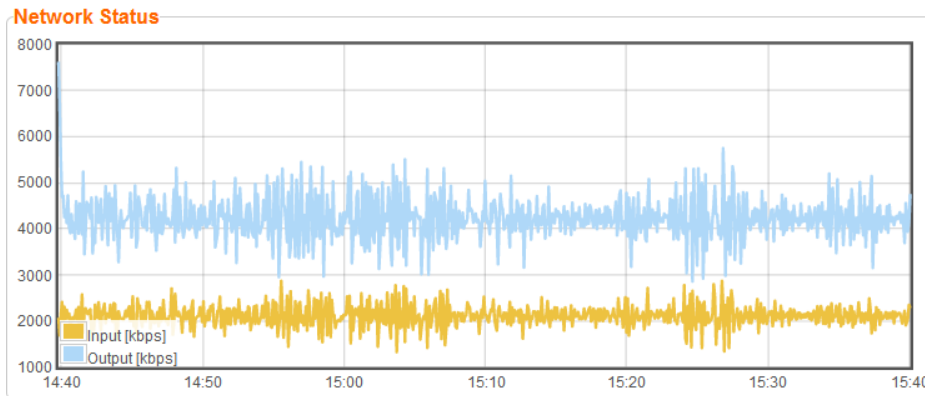

Viewing Current License Information

You can view the current license information in the **License Information** section.

Metered License Monitoring

If you have a metered license (based on usage), you can view the license conditions and monitor your current usage status under the License Information section on the main screen.

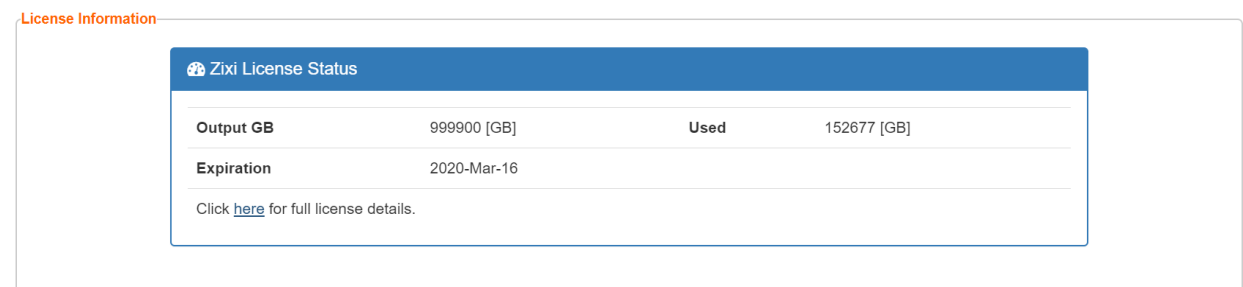

The section includes the following elements:

Element	Description
Output GB	The total amount of output traffic in GB per month that is allowed in the license.
Expiration	License expiration date.
Used	The actual usage this month so far in GB.

Viewing Status

Viewing Current License Information

To view additional license terms and usage statistics, click the link at the bottom of the Zixi License Status box.

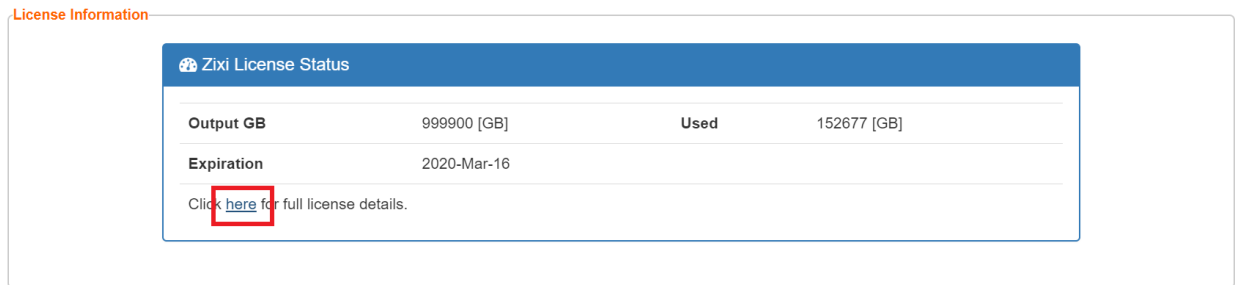

The License Status Screen is displayed.

Viewing Status

Viewing Current License Information

License Status Screen

Zixi License Status

Application

Product	Key
Broadcaster_new	demo-f14c-c546-6784

Meters

Meter	Expiration
Output GB	999900 [GB] 16-Mar-2020
Available	999900 [GB] Used 152677 [GB]
Expires	2020-Mar-16

Limits

	Input	Output
Bitrate	Unlimited	Unlimited
Zixi Pull	Unlimited	Unlimited
Zixi Push	Unlimited	Unlimited
RTMP Pull	Unlimited	Unlimited
RTMP Push	Unlimited	Unlimited
UDP	Unlimited	Unlimited
ASI	Unlimited	Unlimited
Transcoders	999	

Features

	Supported
HLS, HDS, FLV, MPEG-DASH, VOD & RTMP	<input checked="" type="checkbox"/>
Receivers & UDP	<input checked="" type="checkbox"/>
SMPTE 2022 FEC for RTP	<input checked="" type="checkbox"/>
TR101 Stream analysis	<input checked="" type="checkbox"/>
File transfer & Zixi accelerated HLS/HDS	<input checked="" type="checkbox"/>
Cluster	<input checked="" type="checkbox"/>
Matrix	<input checked="" type="checkbox"/>
Bonding	<input checked="" type="checkbox"/>
Time shifting	<input checked="" type="checkbox"/>
x264 Transcoding	<input type="checkbox"/>

Daily Usage

Host: All

Daily Bitrate

Host: All

The screen includes the following elements:

Viewing Status

Machine Information

Element	Description
Application	The product version and license key.
Meters	<ul style="list-style-type: none">• Output GB - The total amount of output traffic in GB per month that is allowed in the license.• Expires - license expiration date.• Available - the total amount of traffic in GB per month that is allowed in the license.• Used - the actual usage this month so far in GB.
Limits	License usage restrictions. Unlimited - no restrictions.
Features	List of enabled/disabled features.
Daily Usage	Daily traffic statistics. Click the Host drop-down menu to select a specific host.
Daily Bitrate	Daily bitrate statistics. Click the Host drop-down menu to select a specific host.

Machine Information

This pane shows information about the machine on which the Broadcaster is installed.

Machine Information

System Model: Xen HVM domU
Processor Model: Intel(R) Xeon(R) CPU E5-2686 v4 @ 2.30GHz
Processors: 1
Logical Cores: 2
Installed RAM: 4 GB
GPU(s): Not Found

The pane includes the following data:

Parameter	Description
System Model	The model of the machine on which the Broadcaster is installed.
Processor Model	The model and specifications of the machine's processor.
Processor	The number of CPUs installed on this machine.
Logical Cores	The number of logical cores per processor (for each processor).

Viewing Status

Operating System Information

Installed RAM	The size of the RAM installed on the machine.
----------------------	---

GPU(s)	The number of GPUs. If no GPUs - Not Found.
---------------	---

Operating System Information

This pane shows information about the operating system running on the machine.

OS Information

```
OS: Amazon Linux release 2 (Karoo)
Build: 4.14.88-88.73.amzn2.x86_64
Architecture: x86_64
```

The pane Includes the following data:

Parameter	Description
OS	The operating system running on the machine.
Build	The operating system build (version) number.
Architecture	The system architecture of the operating system, number of bits.

Network Cards (Linux only)

This pane shows information about the network cards running on the machine. Each line represents another network card.

Network Cards

NIC	Link Speed	Duplex	IPs
eth0		Full	172.31.17.149

The pane Includes the following data:

Parameter	Description
NIC	The name of the Network Interface Controller (a.k.a network card).
Link Speed	The link speed capability of the network card.
Duplex	Full - full duplex Half - half duplex
IPs	The IP of the network card.

Network Test





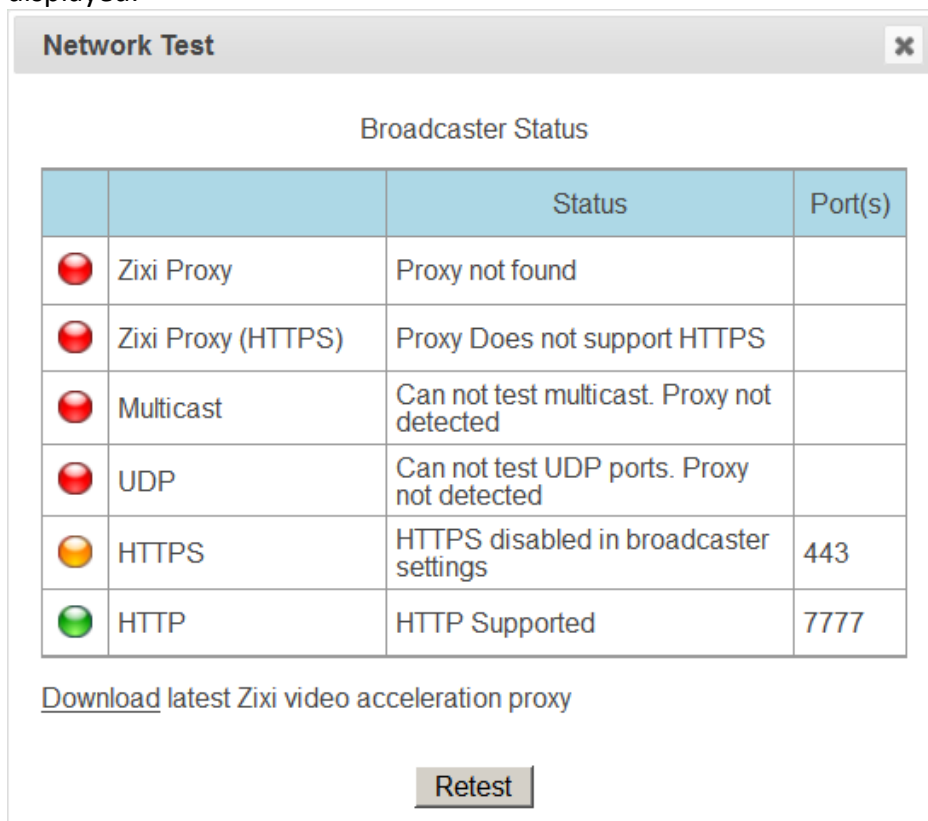

You can test the Zixi Broadcaster status, the status of the http or https connection with the relevant port, and the status of the Zixi Video Acceleration Proxy component. This can be accomplished remotely after the installation of the Broadcaster and subsequently any time after that.

➔ To Test the Network:

1. In the Zixi Broadcaster **Status** page, click . The **Network Test** screen is displayed:



The screenshot shows a window titled "Network Test" with a close button. Inside, there is a section titled "Broadcaster Status" containing a table with the following data:

		Status	Port(s)
	Zixi Proxy	Proxy not found	
	Zixi Proxy (HTTPS)	Proxy Does not support HTTPS	
	Multicast	Can not test multicast. Proxy not detected	
	UDP	Can not test UDP ports. Proxy not detected	
	HTTPS	HTTPS disabled in broadcaster settings	443
	HTTP	HTTP Supported	7777

Below the table is a link: [Download latest Zixi video acceleration proxy](#). At the bottom center is a "Retest" button.

The Broadcaster Status table lists the various components of the Zixi Broadcaster with the relevant ports and status (description) and the following health indicators:

- **Green** – component has been tested and was found available.
 - **Yellow** – component has been disabled.
 - **Red** – component was not found or is not available.
2. Click **Retest** to run an additional test on all the server's current connections and their relative ports.

The following tests will be displayed:

Network Test

Installing the Zixi Video Acceleration Proxy

- **Zixi Proxy** – checks that the Zixi Video Acceleration Proxy is running on the local machine and is listening through port 4500 (HTTP).
- **Zixi Proxy (HTTPS)** – checks that the Zixi Video Acceleration Proxy is running on the local machine and is listening through port 4501 (HTTPS).
- **Multicast** – checks if the multicast feature is enabled.
- **UDP** – checks if Zixi Broadcaster can be accessed through UDP (port 2077).
- **HTTP** – checks is Zixi Broadcaster can be accessed through HTTP (HTTP server port 80).
- **HTTPS** - checks is Zixi Broadcaster can be accessed through HTTPS (HTTPS server port 8080)

Installing the Zixi Video Acceleration Proxy

The Zixi Video Acceleration Proxy is a software component, which is installed on the local machine, that enables pulling a stream from Zixi Broadcaster over HTTP, while using the Zixi protocol. The Zixi Video Acceleration Proxy is mainly used to preview a stream to assess its quality, by playing it on a local player. VLC video player has another version of the proxy, called Zixi VLC Plugin, which offers the same functionality. For more information, see [Zixi VLC Plugin Setup Guide](#).

The Zixi Video Acceleration Proxy component is installed on the local machine, while Zixi Broadcaster can be running on another machine (e.g., in the cloud) or can be running on the same machine. The Proxy uses port 4500 (HTTP) or 4501 (HTTPS) to listen to the stream.

The Zixi Video Acceleration Proxy is also required when using Zixi Broadcaster to transfer large files. In this case, the component allows both uploading and downloading the files. For more information, see [Accelerated File Transfer](#).

➔ To Install the Zixi Video Acceleration Proxy:

1. In the Zixi Broadcaster **Status** page, click . The **Network Test** screen is displayed.

Network Test

Installing the Zixi Video Acceleration Proxy

2. On the **Network Test** screen, click the **Download** link below the table.

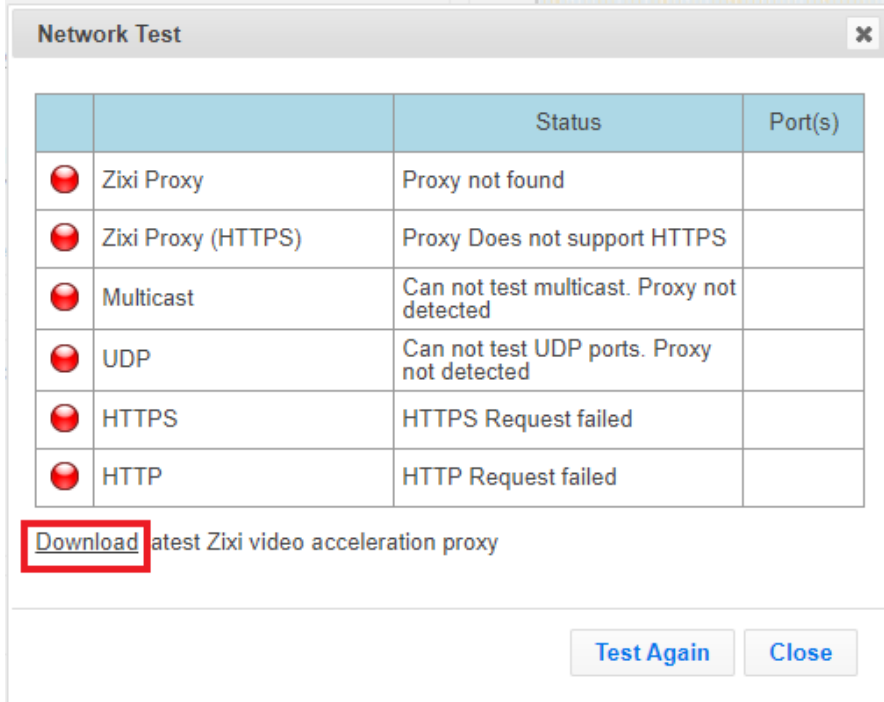

The setup file will be downloaded locally.

3. Run the downloaded file to open the setup wizard.

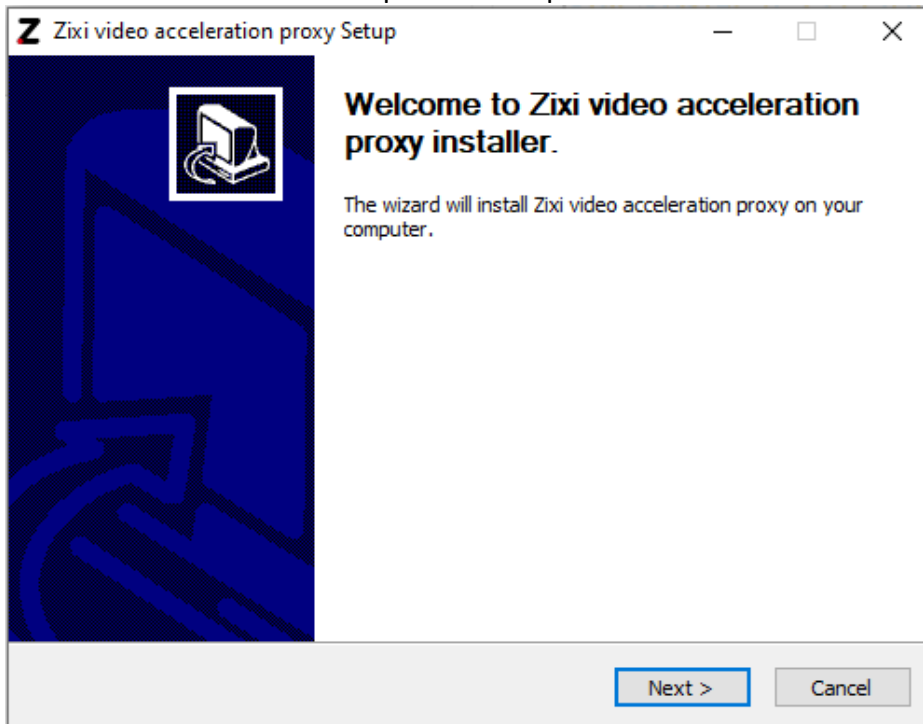

4. Click **Next**.

Network Test

Installing the Zixi Video Acceleration Proxy

5. Select a destination folder to install.

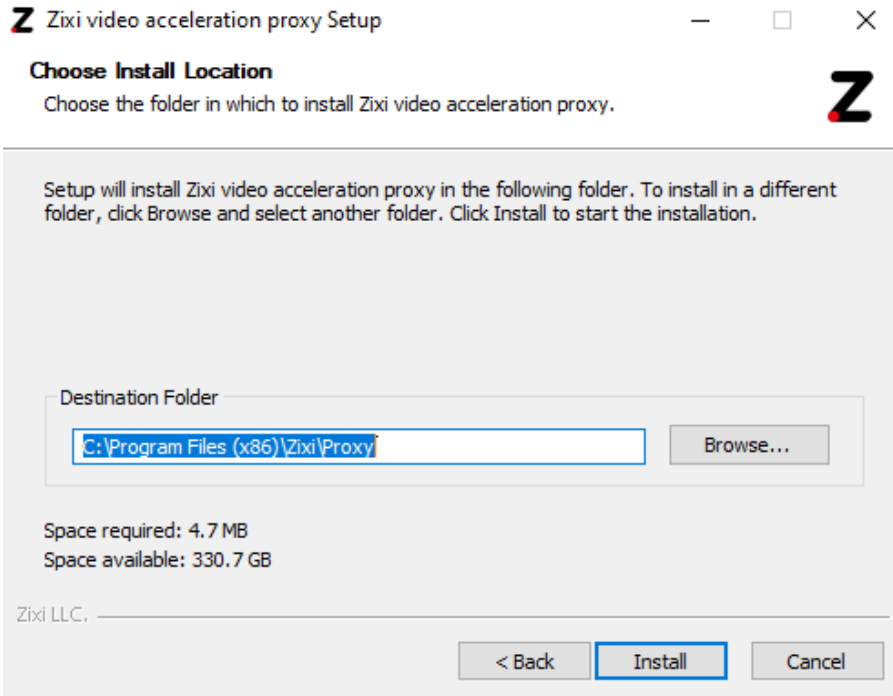

6. Click **Install**.
7. After the installation process, click **Finish**.

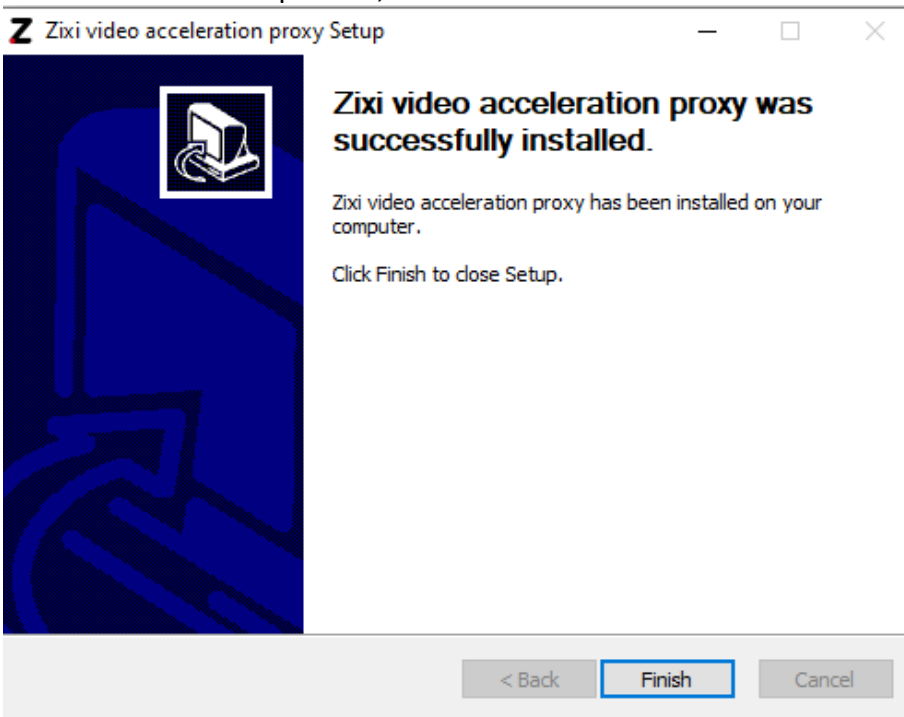





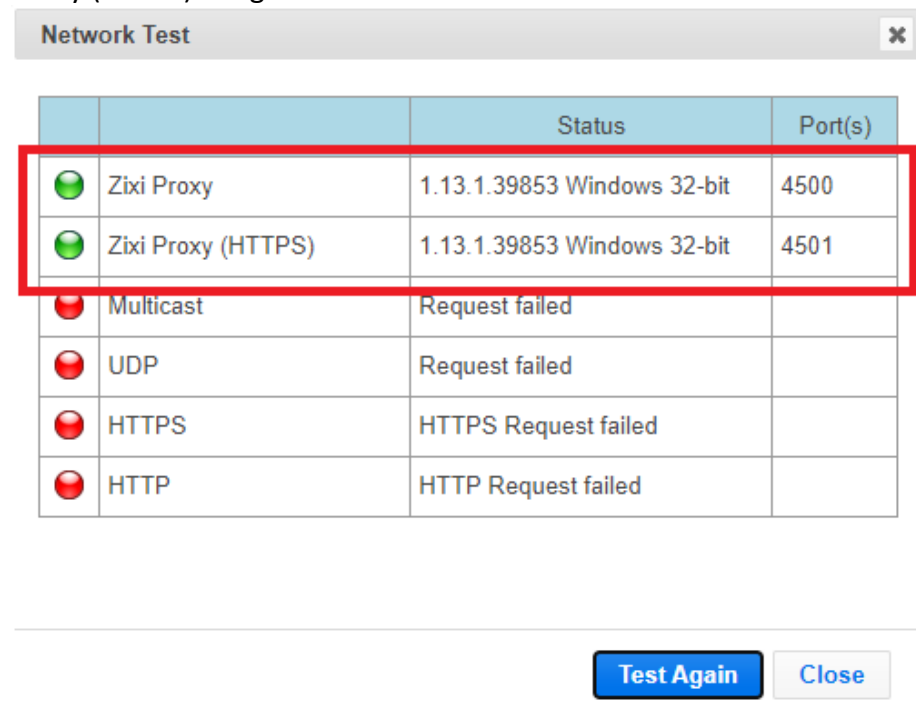

Network Test

Using the Zixi Video Acceleration Proxy for previewing a stream

If you will run the network test again, you should be able to see that the Zixi Proxy and Zixi Proxy (HTTPS) are green.



		Status	Port(s)
	Zixi Proxy	1.13.1.39853 Windows 32-bit	4500
	Zixi Proxy (HTTPS)	1.13.1.39853 Windows 32-bit	4501
	Multicast	Request failed	
	UDP	Request failed	
	HTTPS	HTTPS Request failed	
	HTTP	HTTP Request failed	

Test Again **Close**

Using the Zixi Video Acceleration Proxy for previewing a stream

The Zixi Video Acceleration Proxy can be used for previewing a stream through a video player. The locally installed Proxy can be accessed through the following IP address – 127.0.0.1. The following URL - 127.0.0.1:4500/version.json will provide a response that includes the version and build numbers of the Proxy.

➔ To playback a stream using the Zixi Video Acceleration Proxy:

1. In a web-connected video player, enter the following network URL:
http://127.0.0.1:4500/?url=<broadcaster_ip>:2077/<stream_name>.

Network Test

Using the Zixi Video Acceleration Proxy for previewing a stream

The video will be streamed to the player through the locally installed Proxy.

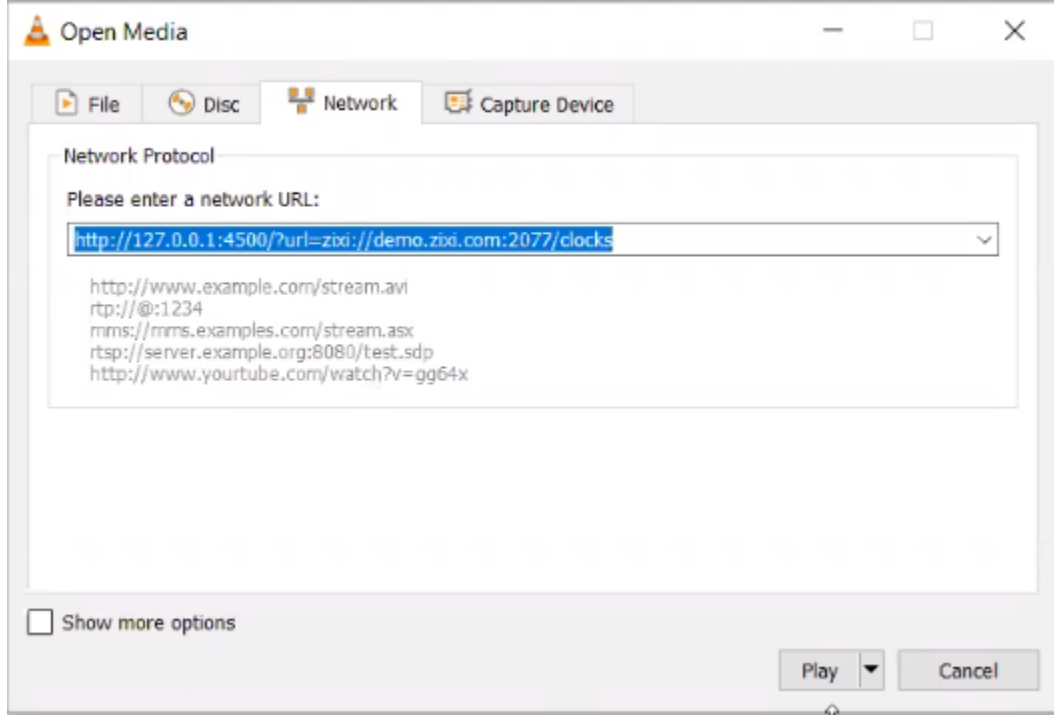

Broadcaster Inputs

You can add input streams to Zixi Broadcaster from one of the following sources:

- **Zixi (Push)** – ZEC or Zixi Broadcaster pushes the stream to the Zixi Broadcaster. Since both ZEC and the Zixi Broadcaster use the Zixi protocol, the stream is protected by the Zixi protocol.
- **Zixi (Pull)** – the Zixi Broadcaster can pull a stream from another Zixi Broadcaster. Since both components use the Zixi protocol, the stream can be protected by the Zixi protocol.
- **UDP streams** – the source is a UDP or RTP stream, RTP + SMPTE 2022 FEC over unicast or multicast.
- **RTMP** – The source is an RTMP stream, pushed into the Zixi Broadcaster or pulled by it.
- **RTSP** – The source is an RTSP stream, pushed into the Zixi Broadcaster, or pulled by it.
- **HLS** – The source is an HLS stream that is pulled by the Zixi Broadcaster.
- **HTTP Pull/Push (TS over HTTP)** – The source is a Transport Stream over HTTP, which is pushed into Zixi Broadcaster or pulled by it.
- **SRT Caller/Push** – The source is an SRT client that pushes the stream into Zixi Broadcaster. The connection is initiated by the source SRT client.
- **SRT Listener/Pull** – The source includes an SRT stream that is pulled by Zixi Broadcaster. The connection is initiated by Zixi Broadcaster.
- **RIST** – The source is a RIST stream using Simple or Main Profile over unicast or multicast.
- **NDI** – The source is an NDI stream that is pulled into Zixi Broadcaster using the auto-discovery mechanism.
- **WebRTC** – The source is a webcam and microphone from a web browser. Contact Zixi support for more information on configuration.
- **File over HTTP** – The source is a file on an HTTP server (e.g. S3) that is copied to a temporary location on the local computer.
- **Multiplex** – Takes multiple Single Program Transport Streams and combines them into one Multi Program Transport Stream file.
- **Local files** – the source in this case is a local transport stream file from your local computer or local network.
- **Delayed** – the source in this case is a local transport stream file from your local computer or local network and delayed according to the specified duration.

Adding Input Streams

The Zixi Broadcaster enables you to add various types of streams. When you create a new stream, select the stream type and then fill in the fields that are applicable for that stream type.

Adding Push Streams

Typically, a Push Stream is transmitted from ZEC. In this case, the stream is initiated by ZEC while the Zixi Broadcaster remains in “listening mode” until the stream is initiated.

If the stream is an MPTS stream and you want to demux it into separate SPTS input streams, create the stream, by following the instructions below, and then follow the instruction in the [Demuxing an MPTS Stream](#) section.

The error recovery techniques implemented in the Zixi protocol Push streams are protected under U.S. patent 11,546,615.

➔ To Add a Push Stream:

1. In the Zixi Broadcaster Navigation menu, click the **Inputs** tab.
2. In the **Menu** bar, click **New Input**. The **Add a new input stream** window is displayed.

Stream ID:

Max Outputs:

Show in Matrix:

Push Pull UDP Delayed File RTMP RTSP HLS TS over HTTP SRT SRT Client RIST NDI WebRTC File over HTTP Multiplex

Stream parameters

Password:

Latency [ms]:

Point to point:

ID of high priority source:

Remote configuration

Disable P2P fallback:

None

Billing Codes

Enable time shift

Enable multicast on pull outputs

Decrypt stream

Enable encryption

Recording parameters

Ok Cancel

3. Enter the unique **Stream ID** for the Broadcaster.



This must be identical (case sensitive) to the stream name configured in ZEC.

4. Select the maximum concurrent connections to this stream from the **Max. Outputs** drop-down list. Default: Unlimited.



This setting can be modified without interrupting an existing stream.



5. Select the **Show in Matrix** checkbox to display this stream in the Matrix (see [Using the Matrix](#)). Default: Selected.
6. Select **Push** for this input stream.
7. Specify the **Stream Parameters** (see Input Stream Parameters Table below).

Broadcaster Inputs

Adding Input Streams

8. If you want to specify **Billing Codes** to identify and differentiate traffic on a Zixi Broadcaster for billing purposes, select this checkbox (see Input Stream Parameter Table below).
9. If you want to **Enable time shift**, select this checkbox (see Input Stream Parameter Table below). The stream will be recorded and broadcasted after the specified delay. The time shift feature is typically used to broadcast a live event across time zones (due to the time differences between locations).
10. If you want to **Enable multicast on pull outputs**, select this checkbox (see Input Stream Parameter Table).
11. You can decrypt an encrypted stream as it enters Zixi Broadcaster. To decrypt a stream, select the **Decrypt Stream** checkbox and fill in the parameters as describes in the Input Stream Parameter Table below. For more information, see **Decrypting an Input Stream in Zixi Broadcaster**.
12. You can encrypt the stream as it enters Zixi Broadcaster. To encrypt the stream, select the **Enable Encryption** checkbox and fill in the parameters as describes in the Input Stream Parameter Table below. For more information, see **Encrypting an Input Stream in Zixi Broadcaster**.
13. If you want to record the stream, you can configure the **Recording Parameters** (see Input Stream Parameter Table).
14. Click **OK**. The “Input added” message appears on the top of the screen. The Push Stream from the Zixi Feeder/ZEC is added to the Zixi Broadcaster and now appears in the list of input streams available in the Zixi Broadcaster input UI.

Input Stream Parameters Table

Parameter	Description
Stream Parameters	
Password (Optional)	<p>If desired, enter a password string to use for authentication (must be identical to the string configured in ZEC)</p> <p> This setting can be modified without interrupting an existing stream.</p>
Latency [ms]	<p>Specify the maximal latency that will override the latency that was defined in ZEC (in ms). Default: Remote configuration (i.e. use the latency that was set in ZEC). (See Latency Considerations)</p> <p> This setting can be modified without interrupting an existing stream.</p>

Broadcaster Inputs

Adding Input Streams

Point to point only	This option is no longer supported.
Disable P2P Fallback	Selecting this checkbox will allow <u>only</u> P2P (disabling the option to re-route traffic though the Zixi Broadcaster)
ID of high priority source	This option is no longer supported.
Billing Codes	Billing codes are used to identify and differentiate traffic on a Zixi Broadcaster for billing purposes. When a billing code is added to a Source or Target, Zixi can track the traffic on that Broadcaster input or output separately from other inputs and outputs on the same Broadcaster. Billing codes are created by Zixi personnel on the Zixi Customer Portal for a particular organization.
Billing Code	Enter the billing code that corresponds to this stream. The relevant billing can be obtained from the organization that received the billing code from Zixi.
Billing password	Enter the password that corresponds to this billing code.
Enable time shift	Select this checkbox to record the stream content and broadcast it after a specified delay. To deploy an input stream that uses the current stream's time shift, you need to configure a "Delayed" input stream. (See Adding Delayed Streams).
Maximum delay [hh:mm:ss]	Specify the time of the delayed transmission of this stream. Maximum: 24 hours.
Enable multicast on pull outputs	Select this checkbox to enable the transmission of this stream's outputs as multicast. A Zixi receiver that will pull the stream will receive it in multicast. By default, Zixi Broadcaster is configured to allow transparent fallback to unicast if it is out of the LAN. Requires enabling Multicast Pull in the Settings .
Multicast Only	Selecting this checkbox will force the transmission of this stream only in multicast.
Decrypt stream	Select this checkbox to decrypt the Input stream. Please note that the stream will not be encrypted as it passes through the Zixi path. For more information, see Decrypting an Input Stream in Zixi Broadcaster .
	Specify the type of encryption that is being used in the stream.
Decryption type (for Decrypt stream enabled)	 This setting can be modified without interrupting an existing stream.

Broadcaster Inputs

Adding Input Streams

Specify the key for decryption.

Decryption key
(for Decrypt
stream enabled)



This setting can be modified without interrupting an existing stream.

**Enable
Encryption**

Select this checkbox to encrypt the Input stream. For more information, see [Encrypting an Input Stream in Zixi Broadcaster](#).

Encryption type
(for Encryption
enabled)

Specify the type of Encryption (AES 128/192/256).

Encryption key
(for Encryption
enabled)

Click **Generate** to generate an encryption key. The generated encryption key must be sent to the end-user to decipher the received encoded stream.

**Recording
parameters**

Select this checkbox to customize the recording parameters.

Select the radio button for the desired storage type and then fill in the relevant parameters.

Destination Type

- **Record to disk** – the recording is saved on the local disk. It is possible to record to an external destination by replacing the default storage location with a symbolic link. To learn more, see [Using an External Storage](#) section.
- **Record to S3** – the file is saved to your AWS S3 Bucket. The mechanism uses AWS multipart upload. Amazon advises to define a lifetime rule for objects on destination bucket.

**Record to Disk
Parameters**

Broadcaster Inputs

Adding Input Streams

Specify the file name pattern that Zixi will use to generate when saving the recorded content. A separate file will be generated for each recording up to the time specified in the Max recorded file duration parameter (see above). After this duration a new file will be generated.

The file name pattern can include any string and up to five variables listed below. Only the %T=HH.MM.SS creation time is mandatory. You can change the order of these variables and add text as long as you maintain the legitimate structure of the file in Linux and Windows:

File Name Template

- %S=stream id – optional.
- %Y=year – optional
- %M=month – optional
- %D=day – optional
- %T=HH.MM.SS creation time – mandatory
- %U=YYYYmmddTHHMMSSZ UTC timestamp – optional

For example, the following pattern %Y_recording%T.ts will generate the following file name 2017_recording15:32:35.ts.

Max recorded file duration [HH:MM]

Specify the maximum time allotted for recording a video stream. Default: 2 hours

Keep recorded files for [HH:MM]

Specify the maximum time for storing the recording. Default: 0 hours

Custom Path

Optionally specify a storage location for the recorded files that is relative to the root folder. This location bypasses the location specified as the root folder in the **Settings > General** screen.

Record to S3 Parameters

Broadcaster Inputs

Adding Input Streams

Specify the file name pattern that Zixi will use to generate when saving the recorded content. A separate file will be generated for each recording up to the time specified in the Max recorded file duration parameter (see above). After this duration a new file will be generated.

The file name pattern can include any string and up to five variables listed below. Only the %T=HH.MM.SS creation time is mandatory. You can change the order of these variables and add text as long as you maintain the legitimate structure of the file in Linux and Windows:

File Name Template

- %S=stream id – optional.
- %Y=year – optional
- %M=month – optional
- %D=day – optional
- %T=HH.MM.SS creation time – mandatory
- %U=YYYYmmddTHHMMSSZ UTC timestamp – optional

For example, the following pattern %Y_recording%T.ts will generate the following file name 2017_recording15:32:35.ts.

Max recorded file duration [HH:MM]

Specify the maximum time allotted for recording a video stream. Default: 2 hours

URL

Specify the URL of the S3 bucket.

Ignore TLS certificate errors

TLS certificate for S3 bucket might be detected as faulty if bucket name contains dot[s]. When this option is selected, Zixi Broadcaster will ignore the TLS certificate errors and transmit the stream to its destination.

Access Key

The access key that is used for accessing the S3 bucket.

Secret Key

The secret key that is used for accessing the S3 bucket.

Broadcaster Inputs

Adding Input Streams

Adding Pull Streams

Typically, a Pull Stream is transmitted from another Zixi Broadcaster. In this case, the stream is initiated by your Zixi Broadcaster.

If the stream is an MPTS stream and you want to demux it into separate SPTS input streams, create the stream, by following the instructions below, and then follow the instruction in the [Demuxing an MPTS Stream](#) section.

The error recovery techniques implemented in the Zixi protocol Pull streams are protected under U.S. patent 11,546,615.

➔ To Add a Pull Stream:

1. In the Zixi Broadcaster Navigation menu, click the **Inputs** tab.
2. In the Menu bar, click **New Input**. The **Add a new input stream** window is displayed.
3. Enter the unique **Stream ID**. For the Broadcaster.



Note: this must be identical (case sensitive) to the stream name configured in ZEC.

4. Select the maximum concurrent connections to this stream from the **Max. Outputs** drop-down list. Default: Unlimited.



This setting can be modified without interrupting an existing stream.

5. Select the **Show in Matrix** check box to display this stream in the Matrix (see [Using the Matrix](#)). Default: Selected.
6. Select **Pull** for the input stream.

The screenshot shows the 'Add new input stream' dialog box. The 'Stream ID' field contains '123456789'. The 'Max Outputs' dropdown is set to 'Unlimited'. The 'Show in Matrix' checkbox is checked. The 'Pull' radio button is selected. The 'Stream parameters' section includes fields for Host, Port (2088), Stream, Password, Latency (4000), Ignore TLS certificate errors, and Bind to IP (Any). There are also checkboxes for Billing Codes, Enable time shift, Enable multicast on pull outputs, Decrypt stream, and Enable encryption. A Recording parameters section is also visible. Ok and Cancel buttons are at the bottom right.

7. Specify the **Stream Parameters** (see Input Stream Parameter table).

Broadcaster Inputs

Adding Input Streams



8. If you want to specify **Billing Codes** to identify and differentiate traffic on a Zixi Broadcaster for billing purposes, select this checkbox (see Input Stream Parameter Table below).
9. If you want to **Enable time shift**, select this checkbox (see Input Stream Parameter table). The stream will be recorded and broadcasted after the specified delay. The time shift feature is typically used to broadcast a live event across time zones (due to the time differences between locations).
10. If you want to **Enable multicast on pull outputs**, select this checkbox (see Input Stream Parameter table).
11. You can decrypt an encrypted stream as it enters the Zixi Broadcaster. To decrypt a stream, select the **Decrypt Stream** checkbox and fill in the parameters as describes in the Input Stream Parameter Table below. For more information, see **Decrypting an Input Stream in Zixi Broadcaster**.
12. You can encrypt the stream as it enters Zixi Broadcaster. To encrypt the stream, select the **Enable Encryption** checkbox and fill in the parameters as describes in the Input Stream Parameter Table below. For more information, see **Encrypting an Input Stream in Zixi Broadcaster**.
13. If you want to configure the **Recording Parameters**, specify them in the respective fields (see Input Stream Parameter table).
14. Click **OK**. The “Input added” message appears on the top of the screen. The Push Stream from ZEC is added to the Zixi Broadcaster and now appears in the list of streams available in Zixi Broadcaster inputs UI.

Input Stream Parameters table

Parameter	Description
Stream Parameters	The general stream settings.
Host	Enter the IP Address of the remote Broadcaster server. Note that additional (failover) destinations can be added by clicking the adjacent “+” button
Port	Enter the port through which the Broadcaster receives the stream from another Broadcaster server. Default: 2088 The default input port for Zixi Broadcaster is UDP port 2088 . This port <i>must be open</i> on any firewalls between Zixi Broadcaster and other devices it is communicating with.
Stream	Enter the unique stream ID from another Broadcaster server.
Password (Optional)	If desired, enter the string for authentication. It must be identical to the string configured on the other Zixi Broadcaster.

Broadcaster Inputs

Adding Input Streams

Latency [ms]	Specify the maximum number of milliseconds that Zixi Broadcaster should protect the stream for. For example, 6000 milliseconds would ensure that the stream is protected for up to six seconds of delay in the network. This setting affects memory usage as higher levels of protection require more buffering. Default:6000.
Ignore TLS certificate errors	Select this option when connecting to a trusted server that does not have a valid certificate. When this option is selected, Zixi Broadcaster will ignore the TLS certificate errors.  This setting can be modified without interrupting an existing stream.
Bind to IP	Select from the drop-down list the local IP address to be used for this Input, OR select <i>Any</i> to enable any IP to be used.
Bind to NIC	Select from the drop-down list the NIC to be used for this Input, OR select <i>Any</i> to enable any NIC to be used.
Billing Codes	Billing codes are used to identify and differentiate traffic on a Zixi Broadcaster for billing purposes. When a billing code is added to a Source or Target, Zixi can track the traffic on that Broadcaster input or output separately from other inputs and outputs on the same Broadcaster. Billing codes are created by Zixi personnel on the Zixi Customer Portal for a particular organization.
Billing Code	Enter the billing code that corresponds to this stream. The relevant billing can be obtained from the organization that received the billing code from Zixi.
Billing password	Enter the password that corresponds to this billing code.
Enable time shift	Select this checkbox to record the stream content and broadcast it after a specified delay. To deploy an input stream that uses the current stream's time shift, you need to configure a "Delayed" input stream. (See Adding Delayed Streams).
Maximum delay [hh:mm:ss] (for Time Shift enabled)	Specify the time of a delayed transmission of this stream. Maximum: 24 hours
Enable multicast on pull outputs	Select this checkbox to enable the transmission of this stream's outputs as multicast. A Zixi Broadcaster that will pull the stream will receive it in multicast. By default, Zixi Broadcaster is configured to allow transparent fallback to unicast if it is out of the LAN. Requires enabling Multicast Pull in the Settings .  This setting can be modified without interrupting an existing stream.

Broadcaster Inputs

Adding Input Streams

Multicast-Only (for multicast enabled)

If desired, specify multicast-only outputs.

Decrypt stream

Select this checkbox to decrypt the Input stream. Please note that the stream will not be encrypted as it passes through the Zixi path. For more information, see [Decrypting an Input Stream in Zixi Broadcaster](#).

Specify the type of encryption that is being used in the stream.

Decryption type (for Decrypt stream enabled)



This setting can be modified without interrupting an existing stream.

Specify the key for decryption.

Decryption key (for Decrypt stream enabled)



This setting can be modified without interrupting an existing stream.

Enable Encryption

Select this checkbox to encrypt the Input stream. For more information, see [Encrypting an Input Stream in Zixi Broadcaster](#).

Encryption type (for Encryption enabled)

Specify the type of Encryption (AES 128/192/256).

Encryption key (for Encryption enabled)

Click **Generate** to generate an encryption key. The generated encryption key must be sent to the end-user to decipher the received encoded stream.

Recording parameters

Select this checkbox to customize the recording parameters.

Select the radio button for the desired storage type and then fill in the relevant parameters.

Destination Type

- **Record to disk** – the recording is saved on the local disk. It is possible to record to an external destination by replacing the default storage location with a symbolic link. To learn more, see [Using an External Storage](#) section.
- **Record to S3** – the file is saved to your AWS S3 Bucket. The mechanism uses AWS multipart upload. Amazon advises to define a lifetime rule for objects on destination bucket.

Broadcaster Inputs

Adding Input Streams

Record to Disk

Parameters

File Name Template	<p>Specify the file name pattern that Zixi will use to generate when saving the recorded content. A separate file will be generated for each recording up to the time specified in the Max recorded file duration parameter (see above). After this duration a new file will be generated.</p> <p>The file name pattern can include any string and up to five variables listed below. Only the %T=HH.MM.SS creation time is mandatory. You can change the order of these variables and add text as long as you maintain the legitimate structure of the file in Linux and Windows:</p> <ul style="list-style-type: none">• %S=stream id – optional.• %Y=year – optional• %M=month – optional• %D=day – optional• %T=HH.MM.SS creation time – mandatory• %U=YYYYmmddTHHMMSSZ UTC timestamp – optional <p>For example, the following pattern %Y_recording%T.ts will generate the following file name 2017_recording15:32:35.ts.</p>
---------------------------	--

Max recorded file duration [HH:MM]	Specify the maximum time allotted for recording a video stream. Default: 2 hours
---	--

Keep recorded files for [HH:MM]	Specify the maximum time for storing the recording. Default: 0 hours
--	--

Custom Path	Optionally specify a storage location for the recorded files that is relative to the root folder. This location bypasses the location specified as the root folder in the Settings > General screen.
--------------------	--

Record to S3

Parameters

Broadcaster Inputs

Adding Input Streams

File Name Template	<p>Specify the file name pattern that Zixi will use to generate when saving the recorded content. A separate file will be generated for each recording up to the time specified in the Max recorded file duration parameter (see above). After this duration a new file will be generated.</p> <p>The file name pattern can include any string and up to five variables listed below. Only the %T=HH.MM.SS creation time is mandatory. You can change the order of these variables and add text as long as you maintain the legitimate structure of the file in Linux and Windows:</p> <ul style="list-style-type: none">• %S=stream id – optional.• %Y=year – optional• %M=month – optional• %D=day – optional• %T=HH.MM.SS creation time – mandatory• %U=YYYYmmddTHHMMSSZ UTC timestamp – optional <p>For example, the following pattern %Y_recording%T.ts will generate the following file name 2017_recording15:32:35.ts.</p>
Max recorded file duration [HH:MM]	Specify the maximum time allotted for recording a video stream. Default: 2 hours
URL	Specify the URL of the S3 bucket.
Ignore TLS certificate errors	TLS certificate for S3 bucket might be detected as faulty if bucket name contains dot[s]. When this option is selected, Zixi Broadcaster will ignore the TLS certificate errors and transmit the stream to its destination.
Access Key	The access key that is used for accessing the S3 bucket.
Secret Key	The secret key that is used for accessing the S3 bucket.

Adding UDP Streams

This enables the Broadcaster to receive a UDP stream. The UDP stream is not protected by the Zixi protocol. The UDP streams can be one of the following types:

- **UDP** – the input stream is plain UDP.
- **RTP** – the input stream uses the RTP protocol, which adds RTP headers to the UDP stream. RTP adds a 12-byte header, which includes a sequence number and a timestamp that can be used to detect dropped packets. The sequence number in the RTP headers can be used to do automatic reordering and the timestamps can help overcome inter-packet gaps, also known as IAT (Inter Arrival Time). However, plain RTP does not feature error recovery or error protection. By default, the RTP headers (which include the timestamps and sequences) are being used on the input side, but then they are stripped off and they no longer propagate to outputs.
- **RTP + SMPTE 2022 FEC** – the input stream includes forward error correction, which enables error recovery or error protection.

If the stream is an MPTS stream and you want to demux it into separate SPTS input streams, create the stream, by following the instructions below, and then follow the instruction in the [Demuxing an MPTS Stream](#) section.

➔ To Add a UDP Stream:

1. In the Zixi Broadcaster Navigation menu, click the **Inputs** tab.
2. In the Menu bar, click **New Input**. The **Add a new input stream** window is displayed.
3. Enter the unique **Stream ID**.



Note this must be identical (case sensitive) to the stream name configured in ZEC.

4. Select the maximum concurrent connections to this stream from the **Max. Outputs** drop-down list. Default: Unlimited.
5. Select the **Show in Matrix** check box to display this stream in the Matrix (see [Using the Matrix](#)). Default: Selected.

Broadcaster Inputs

Adding Input Streams

6. Select **UDP** for the input stream.

The screenshot shows the 'Add new input stream' dialog box. At the top, there are fields for 'Stream ID' (123456789) and 'Max Outputs' (Unlimited). Below these is a 'Show in Matrix' checkbox. A row of radio buttons allows selecting the input type: Push, Pull, UDP (selected), Delayed, File, RTMP, RTSP, HLS, TS over HTTP, SRT, SRT Client, RIST, NDI, WebRTC, File over HTTP, and Multiplex. The 'Stream parameters' section contains several input fields: Port, Multicast IP, SSM source IP, Type (set to UDP), Bind to IP (set to Any), Max Bitrate [kbps] (set to 8000), and Dejitler Buffer [ms] (set to 0). Below this are five checkboxes: Billing Codes, Enable time shift, Enable multicast on pull outputs, Enable encryption, and Recording parameters. 'Ok' and 'Cancel' buttons are located at the bottom right of the dialog.

7. Specify the **Stream Parameters** (see Input Stream Parameters Table).
8. If you want to specify **Billing Codes** to identify and differentiate traffic on a Zixi Broadcaster for billing purposes, select this checkbox (see Input Stream Parameter Table below).
9. If you want to **Enable time shift**, select this checkbox (see Input Stream Parameters Table).
10. If you want to **Enable multicast on pull outputs**, select this checkbox (see Input Stream Parameters Table).
11. If you want to **Enable encryption**, select this checkbox (see Input Stream Parameters Table). For more information, see **Encrypting an Input Stream in Zixi Broadcaster**.
- 12.
13. If you want to configure the **Recording Parameters**, specify them in the respective fields (see Input Stream Parameters Table). Click **OK**.

The “Input added” message appears on the top of the screen. The UDP Stream from ZEC is added to the Zixi Broadcaster and now appears in the list of streams available in the Zixi Broadcaster inputs UI.

Input Stream Parameters Table

Parameter	Description
Stream Parameters	
Port	Specify the port to listen on. This port must be open on all firewalls between the Zixi Broadcaster and other devices it is communicating with.
Multicast IP	If multicast, type the Multicast IP address (or leave blank in the case of Unicast).

Broadcaster Inputs

Adding Input Streams

SSM Source	Specify the source IP for a source-specific multicast.
Type	<p>Select the appropriate protocol type from the drop-down list:</p> <p>UDP – the input stream is plain UDP.</p> <p>RTP – the input stream uses the RTP protocol, which adds RTP headers to the UDP stream. RTP adds a 12-byte header, which includes a sequence number and a timestamp that can be used to detect dropped packets. The sequence number in the RTP headers can be used to do automatic reordering and the timestamps can help overcome inter-packet gaps, also known as IAT (Inter Arrival Time).</p> <p>However, plain RTP does not feature error recovery or error protection. By default, the RTP headers (which include the timestamps and sequences) are being used on the input side, but then they are stripped off and they no longer propagate to outputs.</p> <p>RTP + SMPTE 2022 FEC – the input stream includes forward error correction, which enables error recovery or error protection.</p>
Bind to IP	Select from the drop-down list the local IP address to be used for this Input, OR select <i>Any</i> to enable any IP to be used.
Max. bitrate [kbps]	<p>Specify the maximum expected bitrate for memory allocation. Recommended: 2X the actual bitrate, which will prevent buffer overruns (especially with VBR streams). Default: 8000.</p> <p>Note – Overflows will typically occur when the Max Bitrate isn't sufficient.</p>
Dejitter Buffer [ms]	<p>A buffer size used to de-jitter RTP and UDP inputs. For RTP packet timing is fixed according to packet arrival times and RTP timestamps. For UDP dejittering is only based on arrival times. Default: 0.</p> <p>Assuming that the timestamps in the RTP are accurate, this feature is helpful when the encoder generates an accurate timestamp on the stream, but the arrival is jittery/bursty. In case of jitter, specify a higher value than the RTP input jitter. To view the Jitter level of the input stream, create the input and select it on the Inputs screen, the Jitter metric will be displayed in the Stats pane at the bottom of the screen.</p>
Billing Codes	Billing codes are used to identify and differentiate traffic on a Zixi Broadcaster for billing purposes. When a billing code is added to a Source or Target, Zixi can track the traffic on that Broadcaster input or output separately from other inputs and outputs on the same Broadcaster. Billing codes are created by Zixi personnel on the Zixi Customer Portal for a particular organization.
Billing Code	Enter the billing code that corresponds to this stream. The relevant billing can be obtained from the organization that received the billing code from Zixi.
Billing password	Enter the password that corresponds to this billing code.

Broadcaster Inputs

Adding Input Streams

Enable time shift	Select this checkbox to record the stream content and broadcast it after a specified delay. To deploy an input stream that uses the current stream's time shift, you need to configure a "Delayed" input stream. (See Adding Delayed Streams).
--------------------------	---

Maximum delay [hh:mm:ss] (for Time Shift enabled) Specify the maximum time delay of this input.

Enable multicast on pull outputs	Select this checkbox to enable the transmission of this stream's outputs as multicast. A Zixi receiver that will pull the stream will receive it in multicast. By default Zixi Broadcaster is configured to allow transparent fallback to unicast if it is out of the LAN. Requires enabling Multicast Pull in the Settings.
---	--

Multicast-Only (for multicast enabled) Selecting this checkbox will force the transmission of this stream only in multicast.

Enable Encryption	Select this checkbox to encrypt the Input stream. For more information, see Encrypting an Input Stream in Zixi Broadcaster .
--------------------------	--

Encryption type (for Encryption enabled) Specify the type of Encryption (AES 128/192/256).

Encryption key (for Encryption enabled) Click **Generate** to generate an encryption key. The generated encryption key must be sent to the end-user to decipher the received encoded stream.

Recording parameters	Select this checkbox to customize the recording parameters.
-----------------------------	---

Select the radio button for the desired storage type and then fill in the relevant parameters.

- **Record to disk** – the recording is saved on the local disk. It is possible to record to an external destination by replacing the default storage location with a symbolic link. To learn more, see [Using an External Storage](#) section.
- **Record to S3** – the file is saved to your AWS S3 Bucket. The mechanism uses AWS multipart upload. Amazon advises to define a lifetime rule for objects on destination bucket.

Record to Disk Parameters

Broadcaster Inputs

Adding Input Streams

Specify the file name pattern that Zixi will use to generate when saving the recorded content. A separate file will be generated for each recording up to the time specified in the Max recorded file duration parameter (see above). After this duration a new file will be generated.

The file name pattern can include any string and up to five variables listed below. Only the %T=HH.MM.SS creation time is mandatory. You can change the order of these variables and add text as long as you maintain the legitimate structure of the file in Linux and Windows:

File Name Template

- %S=stream id – optional.
- %Y=year – optional
- %M=month – optional
- %D=day – optional
- %T=HH.MM.SS creation time – mandatory
- %U=YYYYmmddTHHMMSSZ UTC timestamp – optional

For example, the following pattern %Y_recording%T.ts will generate the following file name 2017_recording15:32:35.ts.

Max recorded file duration [HH:MM]

Specify the maximum time allotted for recording a video stream. Default: 2 hours

Keep recorded files for [HH:MM]

Specify the maximum time for storing the recording. Default: 0 hours

Custom Path

Optionally specify a storage location for the recorded files that is relative to the root folder. This location bypasses the location specified as the root folder in the **Settings** > **General** screen.

Record to S3 Parameters

Broadcaster Inputs

Adding Input Streams

File Name Template	<p>Specify the file name pattern that Zixi will use to generate when saving the recorded content. A separate file will be generated for each recording up to the time specified in the Max recorded file duration parameter (see above). After this duration a new file will be generated.</p> <p>The file name pattern can include any string and up to five variables listed below. Only the %T=HH.MM.SS creation time is mandatory. You can change the order of these variables and add text as long as you maintain the legitimate structure of the file in Linux and Windows:</p> <ul style="list-style-type: none">• %S=stream id – optional.• %Y=year – optional• %M=month – optional• %D=day – optional• %T=HH.MM.SS creation time – mandatory <p>For example, the following pattern %Y_recording%T.ts will generate the following file name 2017_recording15:32:35.ts.</p>
Max recorded file duration [hours]	Specify the maximum time allotted for recording a video stream. Default: 2 hours
URL	Specify the URL of the S3 bucket.
Ignore TLS certificate errors	TLS certificate for S3 bucket might be detected as faulty if bucket name contains dot[s]. When this option is selected, Zixi Broadcaster will ignore the TLS certificate errors and transmit the stream to its destination.
Access Key	The access key that is used for accessing the S3 bucket.
Secret Key	The secret key that is used for accessing the S3 bucket.

Adding Delayed Streams

You can delay the broadcasting of an input stream by selecting **Enable time shift** and then creating a **Delayed input stream** that uses the Input with the time shift as a source. In this case the input stream will be stored on the local disk, while a variant of the input is created and delayed according to the specified duration. The input stream of the time-shifted stream will be stored on the local disk. In parallel, you can create a “Delayed” stream that will stream the “time-shifted” input stream according to the specified delay. For example, you can specify a 6-hour time-shift to “stream_A”. This means that 6 hours of streaming are stored. You can then create a delayed stream that will stream “Stream_A” with a two-hour delay. This means that the delayed stream will always stream with a two-hour delay.



The duration of the delayed stream should be less or equal to the time shifted stream.

➔ To Add a Delayed Stream:

1. Make sure at least one of the existing inputs has the **Enable time shift** setting selected.
2. In the Zixi Broadcaster Navigation menu, click the **Inputs** tab.
3. In the Menu bar, click **New Input**. The **Add a new input stream** window is displayed.
4. Enter the unique **Stream ID**.
5. Select the maximum concurrent connections to this stream from the **Max. Outputs** drop-down list. Default: Unlimited.
6. Select the **Show in Matrix** check box to display this stream in the Matrix (see **Using the Matrix**). Default: Selected.
7. Select **Delayed** for the input stream.

The screenshot shows the 'Add new input stream' dialog box. The 'Delayed' radio button is selected. The 'Stream ID' field is empty. The 'Max Outputs' dropdown is set to 'Unlimited'. The 'Show in Matrix' checkbox is checked. The 'Stream parameters' section shows 'Source' as 'qa-elena-push-chub-1-svp2vm', 'Delay [hh:mm:ss]' as '00 : 00 : 00', and 'Enable time shift' and 'Enable multicast on pull outputs' checkboxes are unchecked. 'Ok' and 'Cancel' buttons are at the bottom right.

8. Specify the **Stream Parameters** (see Input Stream Parameters Table).
9. If you want to **Enable time shift**, select this checkbox (see Input Stream Parameters Table).
10. If you want to **Enable multicast on pull outputs**, select this checkbox (see Input Stream Parameters Table).
11. Click **OK**.
The “Input added” message appears on the top of the screen. The Delayed Stream is

Broadcaster Inputs

Adding Input Streams

added to the Zixi Broadcaster and now appears in the list of streams available in the Zixi Broadcaster inputs UI.

Input Stream Parameters Table

Parameter	Description
<i>Stream Parameters</i>	
Source	Select one of the input streams that were configured to enable “time shift”.
Delay	Specify the delay period relative to the original stream in the following format: hh:mm:ss.
<i>Enable time shift</i>	Select this checkbox to record the stream content and broadcast it after a specified delay. To deploy an input stream that uses the current stream’s time shift, you need to configure a “Delayed” input stream. (See Adding Delayed Streams).
Maximum delay [hh:mm:ss] (for Time Shift enabled)	Specify the maximum time delay of this input.
<i>Enable multicast on pull outputs</i>	Select this checkbox to enable the transmission of this stream’s outputs as multicast. A ZEC that will pull the stream will receive it in multicast. By default Zixi Broadcaster is configured to allow transparent fallback to unicast if it is out of the LAN. Requires enabling Multicast Pull in the Settings.
Multicast-Only (for multicast enabled)	Selecting this checkbox will force the transmission of this stream only in multicast.

Adding File Streams

This input creates a file input for the Zixi Broadcaster from a local or mounted disk and subsequently streams it to the end-user.

If the stream is an MPTS stream, you can either upload it as an MPTS file or you can demux it into separate SPTS input streams. To Demux the MPTS stream, create the input stream, by following the instructions below, and then follow the instruction in the [Demuxing an MPTS Stream](#) section.

➔ To Add a File Stream:

1. In the Zixi Broadcaster Navigation menu, click the **Inputs** tab.
In the Menu bar, click **New Input**. The **Add a new input stream** window is displayed.
2. Enter the unique **Stream ID**.



Note: this must be identical (case sensitive) to the stream name configured in ZEC.

3. Select the maximum concurrent connections to this stream from the **Max. Outputs** drop-down list. Default: Unlimited.
4. Select the **Show in Matrix** check box to display this stream in the Matrix (see [Using the Matrix](#)). Default: Selected.
5. Select **File** for the input stream.

The screenshot shows the 'Add new input stream' dialog box. It has a title bar with a close button. The 'Stream ID' field is empty. 'Max Outputs' is set to 'Unlimited'. 'Show in Matrix' is checked. A row of radio buttons includes 'Push', 'Pull', 'UDP', 'Delayed', 'File' (selected), 'RTMP', 'RTSP', 'HLS', 'TS over HTTP', 'SRT', 'SRT Client', 'RIST', 'NDI', 'WebRTC', 'File over HTTP', and 'Multiplex'. Below this is a 'Stream parameters' section with fields for 'Path', 'Enable time shift', 'Enable multicast on pull outputs', and 'Enable encryption'. 'Ok' and 'Cancel' buttons are at the bottom right.

6. Specify the **Stream Parameters** (see Input Stream Parameter table).
7. If you want to **Enable time shift**, select this checkbox (see Input Stream Parameter table). The stream will be recorded and broadcasted after the specified delay. The time shift feature is typically used to broadcast a live event across time zones (due to the time differences between locations).
8. If you want to **Enable multicast on pull outputs**, select this checkbox (see Input Stream Parameter table).
9. If you want to **Enable encryption**, select this checkbox (see Input Stream Parameter table). For more information, see [Encrypting an Input Stream](#) in Zixi Broadcaster.
10. Click **OK**. The “Input added” message appears on the top of the screen. The Push Stream from ZEC is added to the Zixi Broadcaster and now appears in the list of streams available in the Zixi Broadcaster inputs UI.

Broadcaster Inputs

Adding Input Streams

Input Stream Parameters Table

Parameter	Description
Stream Parameters	
Path	Type the local or mounted (Linux) disk or click the adjacent browse button to select the desired one. The suffix .ts indicates a transmitted stream.
Enable time shift	Select this checkbox to record the stream content and broadcast it after a specified delay. To deploy an input stream that uses the current stream's time shift, you need to configure a "Delayed" input stream. (See Adding Delayed Streams).
Maximum delay [hh:mm:ss] (for Time Shift enabled)	Specify the maximum time delay of this input.
Enable multicast on pull outputs	Select this checkbox to enable the transmission of this stream's outputs as multicast. A Zixi receiver that will pull the stream will receive it in multicast. By default, Zixi Broadcaster is configured to allow transparent fallback to unicast if it is out of the LAN. Requires enabling Multicast Pull in the Settings.
Multicast Only (for Multicast enabled)	If desired, specify force multicast-only outputs. A Zixi receiver will receive it in multicast (unless it is out of the LAN in which case it will relay in as unicast). You can also force Multicast only outputs.
Enable Encryption	Select this checkbox to encrypt the Input stream. For more information, see Encrypting an Input Stream in Zixi Broadcaster .
Encryption type (for Encryption enabled)	Specify the type of Encryption (AES 128/192/256).
Encryption key (for encryption enabled)	Click Generate to generate an encryption key. The generated encryption key must be sent to the end-user to decipher the received encoded stream.

Broadcaster Inputs

Adding Input Streams

Adding RTMP Streams

This enables you to create a Push or Pull RTMP input stream.

➔ To Add a RTMP Stream:

1. In the Zixi Broadcaster Navigation menu, click the **Inputs** tab.
2. In the Menu bar, click **New Input**. The **Add a new input stream** window is displayed.
3. Enter the unique **Stream ID**.



Note: this must be identical (case sensitive) to the stream name configured in the ZEC.

4. Select the maximum concurrent connections to this stream from the **Max. Outputs** drop-down list. Default: Unlimited.
5. Select the **Show in Matrix** check box to display this stream in the Matrix (see [Using the Matrix](#)). Default: Selected.
6. Select **RTMP** for the input stream.

Add new input stream

Stream ID:

Max Outputs:

Show in Matrix:

Push Pull UDP Delayed File RTMP RTSP HLS TS over HTTP SRT SRT Client RIST NDI WebRTC File over HTTP Multiplex

Stream parameters

Type: Push Pull

Bind to IP:

Disconnect if inactive:

Muxing Bitrate [kbps]:

Smoothing Latency [ms]:

Billing Codes

Enable time shift

Enable multicast on pull outputs

Enable encryption

Recording parameters

Ok Cancel

Broadcaster Inputs

Adding Input Streams

The screenshot shows the 'Add new input stream' dialog box. At the top, there's a 'Stream ID' field and 'Max Outputs: Unlimited'. Below that, a 'Show in Matrix' checkbox is checked. A row of radio buttons allows selecting the input stream type: Push, Pull, UDP, Delayed, File, RTMP (selected), RTSP, HLS, TS over HTTP, SRT, SRT Client, RIST, NDI, WebRTC, File over HTTP, and Multiplex. The 'Stream parameters' section is expanded, showing: 'Type' with 'Push' and 'Pull' radio buttons; 'URL (rtmp://host:[port]/app):' with the text 'rtmp://localhost/live'; 'Stream name:', 'Username:', and 'Password:' fields; 'Bind to IP:' with a dropdown set to 'Any'; 'Ignore TLS certificate errors:' with an unchecked checkbox; 'Disconnect if inactive:' with a checked checkbox; 'Muxing Bitrate [kbps]:' with a value of '0'; and 'Smoothing Latency [ms]:' with a value of '0'. Below this are checkboxes for 'Billing Codes', 'Enable time shift', 'Enable multicast on pull outputs', and 'Enable encryption'. At the bottom, there's a 'Recording parameters' section and 'Ok' and 'Cancel' buttons.

7. Specify the **Stream Parameters** (see Input Stream Parameters Table).
8. If you want to specify **Billing Codes** to identify and differentiate traffic on a Zixi Broadcaster for billing purposes, select this checkbox (see Input Stream Parameter Table below).
9. If you want to **Enable time shift**, select this checkbox (see Input Stream Parameters Table).
10. If you want to **Enable multicast on pull outputs**, select this checkbox (see Input Stream Parameters Table).
11. If you want to **Enable encryption**, select this checkbox (see Input Stream Parameters Table). For more information, see [Encrypting an Input Stream in Zixi Broadcaster](#).
12. If you want to configure the **Recording Parameters**, specify them in the respective fields (see Input Stream Parameters Table).
13. Click **OK**. The “Input added” message appears on the top of the screen. The RTMP Stream is added to the Zixi Broadcaster and now appears in the list of streams available in the Zixi Broadcaster inputs UI.

Input Stream Parameters Table

Parameter	Description
Stream Parameters	

Select the desired type for the RTMP stream:

Type

- **Push** – the stream is pushed to the Zixi Broadcaster (not initiated by the Zixi Broadcaster). No additional connection parameters need to be filled. If the stream name will match, the stream will be inputted.

Broadcaster Inputs

Adding Input Streams

- Pull – Zixi Broadcaster will initiate the stream by accessing it through the following parameters:

Push Parameters	
Bind to IP	Select from the drop-down list the local IP address to be used for this Input, OR select <i>Any</i> to enable any IP to be used.
Disconnect if inactive	Select this checkbox to disconnect if the stream if not active for 30 seconds.
Muxing Bitrate [kbps]	If the stream's bitrate fluctuates you can pad the stream with null packets to create a steady bitrate. Specify the padding level in kbps.
Smoothing Latency [ms]	The Smoothing feature uses a buffer to time packets according to the stream's clock. This is useful when there are bursts in the rate in which the stream arrives. The smoothing features creates a queue in the buffer, allowing smoother entry into the Broadcaster. The Smoothing parameter defines the size of the buffer in Milliseconds. A larger buffer enables smoother entry, however, it may influence the latency rate.
Pull Parameters	
URL	Type the Stream URL from which the Zixi Broadcaster will access. Use the following URL format: <code>rtmp://host:[port]/app/stream</code> . You can define RTMPS clients with the proven security of a secure socket layer (SSL), by using the <code>rtmps:// url</code>
Stream Name	Type the unique name for the stream that has been defined in the RTMP server.
User Name	Specify the user name to authenticate on the remote RTMP server
Password	Specify the string that is used for authorization on the remote RTMP server.
Bind to IP	Select from the drop-down list the local IP address to be used for this Input, OR select <i>Any</i> to enable any IP to be used.
Ignore TLS certificate	Select this option when connecting to a trusted server that does not have a valid certificate. When this option is selected, Zixi Broadcaster will ignore the TLS certificate errors.
Disconnect if inactive	Disconnects the connection if inactive.
Muxing bitrate (for Padding enabled)	If the stream's bitrate fluctuates you can pad the stream with null packets to create a steady bitrate. Specify the padding level in kbps.
Smoothing	The Smoothing feature uses a buffer to time packets according to the stream's clock. This is useful when there are bursts in the rate in which the stream arrives. The

Broadcaster Inputs

Adding Input Streams

Latency [ms]	smoothing features creates a queue in the buffer, allowing smoother entry into the Broadcaster. The Smoothing parameter defines the size of the buffer in Milliseconds. A larger buffer enables smoother entry, however, it may influence the latency rate.
Billing Codes	Billing codes are used to identify and differentiate traffic on a Zixi Broadcaster for billing purposes. When a billing code is added to a Source or Target, Zixi can track the traffic on that Broadcaster input or output separately from other inputs and outputs on the same Broadcaster. Billing codes are created by Zixi personnel on the Zixi Customer Portal for a particular organization.
Billing Code	Enter the billing code that corresponds to this stream. The relevant billing can be obtained from the organization that received the billing code from Zixi.
Billing password	Enter the password that corresponds to this billing code.
Enable time shift	Select this checkbox to record the stream content and broadcast it after a specified delay. To deploy an input stream that uses the current stream's time shift, you need to configure a "Delayed" input stream. (See Adding Delayed Streams).
Maximum delay [hh:mm:ss] (for Time Shift enabled)	Specify the maximum time delay of this input.
Enable multicast on pull outputs	Select this checkbox to enable the transmission of this stream's outputs as multicast. A Zixi receiver that will pull the stream will receive it in multicast. By default, Zixi Broadcaster is configured to allow transparent fallback to unicast if it is out of the LAN. Requires enabling Multicast Pull in the Settings.
Multicast Only (for Multicast enabled)	Select the check box to force only Multicast outputs.
Enable Encryption	Select this checkbox to encrypt the Input stream. For more information, see Encrypting an Input Stream in Zixi Broadcaster
Encryption type (for Encryption enabled)	Specify the type of Encryption (AES 128/192/256).
Encryption key (for Encryption enabled)	Click Generate to generate an encryption key. The generated encryption key must be sent to the end-user to decipher the received encoded stream.
Recording parameters	Select this checkbox to customize the recording parameters.
Destination Type	Select the radio button for the desired storage type and then fill in the relevant parameters.

Broadcaster Inputs

Adding Input Streams

- **Record to disk** – the recording is saved on the local disk. It is possible to record to an external destination by replacing the default storage location with a symbolic link. To learn more, see [Using an External Storage](#) section.
 - **Record to S3** – the file is saved to your AWS S3 Bucket. The mechanism uses AWS multipart upload. Amazon advises to define a lifetime rule for objects on destination bucket.
-

Record to Disk Parameters

Specify the file name pattern that Zixi will use to generate when saving the recorded content. A separate file will be generated for each recording up to the time specified in the Max recorded file duration parameter (see above). After this duration a new file will be generated.

The file name pattern can include any string and up to five variables listed below. Only the %T=HH.MM.SS creation time is mandatory. You can change the order of these variables and add text as long as you maintain the legitimate structure of the file in Linux and Windows:

File Name Template

- %S=stream id – optional.
- %Y=year – optional
- %M=month – optional
- %D=day – optional
- %T=HH.MM.SS creation time – mandatory
- %U=YYYYmddTHHMMSSZ UTC timestamp – optional

For example, the following pattern %Y_recording%T.ts will generate the following file name 2017_recording15:32:35.ts.

Max recorded file duration [HH:MM]

Specify the maximum time allotted for recording a video stream. Default: 2 hours

Keep recorded files for [HH:MM]

Specify the maximum time for storing the recording. Default: 0 hours

Custom Path

Optionally specify a storage location for the recorded files that is relative to the root folder. This location bypasses the location specified as the root folder in the **Settings > General** screen.

Record to S3 Parameters

Broadcaster Inputs

Adding Input Streams

File Name Template	<p>Specify the file name pattern that Zixi will use to generate when saving the recorded content. A separate file will be generated for each recording up to the time specified in the Max recorded file duration parameter (see above). After this duration a new file will be generated.</p> <p>The file name pattern can include any string and up to five variables listed below. Only the %T=HH.MM.SS creation time is mandatory. You can change the order of these variables and add text as long as you maintain the legitimate structure of the file in Linux and Windows:</p> <ul style="list-style-type: none">• %S=stream id – optional.• %Y=year – optional• %M=month – optional• %D=day – optional• %T=HH.MM.SS creation time – mandatory• %U=YYYYmmddTHHMMSSZ UTC timestamp – optional <p>For example, the following pattern %Y_recording%T.ts will generate the following file name 2017_recording15:32:35.ts.</p>
Max recorded file duration [HH:MM]	Specify the maximum time allotted for recording a video stream. Default: 2 hours
URL	Specify the URL of the S3 bucket.
Ignore TLS certificate errors	TLS certificate for S3 bucket might be detected as faulty if bucket name contains dot[s]. When this option is selected, Zixi Broadcaster will ignore the TLS certificate errors and transmit the stream to its destination.
Access Key	The access key that is used for accessing the S3 bucket.
Secret Key	The secret key that is used for accessing the S3 bucket.

Broadcaster Inputs

Adding Input Streams

Adding RTSP Streams

This enables you to create RTSP streams.

➔ To Add RTSP Streams:

1. In the Zixi Broadcaster Navigation menu, click the **Inputs** tab.
2. In the Menu bar, click **New Input**. The **Add a new input stream** window is displayed.

The screenshot shows the 'Add new input stream' dialog box. The 'Stream ID' field is empty. 'Max Outputs' is set to 'Unlimited'. 'Show in Matrix' is checked. The protocol selection bar shows 'RTSP' selected. The 'Stream parameters' section includes: 'URL (rtsp://host[:port]/stream):' with 'rtsp://localhost:554/' entered, 'Video UDP port:' set to '5000', 'Audio UDP port:' set to '5002', 'Pad to bitrate [kbps]:' set to '0', and 'Smoothing Latency [ms]:' set to '0'. The 'TCP' checkbox is checked. Other checkboxes for 'Billing Codes', 'Enable time shift', 'Enable multicast on pull outputs', 'Enable encryption', and 'Recording parameters' are unchecked. 'Ok' and 'Cancel' buttons are at the bottom right.

3. Enter the unique **Stream ID**.



ZEC.

Note: this must be identical (case sensitive) to the stream name configured in

4. Select the maximum concurrent connections to this stream from the **Max. Outputs** drop-down list. Default: Unlimited.
5. Select the **Show in Matrix** check box to display this stream in the Matrix (see [Using the Matrix](#)). Default: Selected.
6. Select **RTSP** for the input stream.
7. Select the **TCP** checkbox for streams that use TCP protocol. Leave unselected for UDP.
8. Specify the **Stream Parameters** (see Input Stream Parameters Table).
9. If you want to specify **Billing Codes** to identify and differentiate traffic on a Zixi Broadcaster for billing purposes, select this checkbox (see Input Stream Parameter Table below).
10. If you want to **Enable time shift**, select this checkbox (see Input Stream Parameters Table).
11. If you want to **Enable multicast on pull outputs**, select this checkbox (see Input Stream Parameters Table).
12. If you want to **Enable encryption**, select this checkbox (see Input Stream Parameters Table).
13. If you want to configure the **Recording Parameters**, specify them in the respective fields (see Input Stream Parameters Table).

Broadcaster Inputs

Adding Input Streams

14. Click **OK**. The “Input added” message appears on the top of the screen. The RTSP Stream is added to the Zixi Broadcaster and now appears in the list of streams available in the Zixi Broadcaster inputs UI.

Input Stream Parameters Table

Parameter	Description
Stream Parameters	The general stream settings.
URL	Type the Stream URL from which the Zixi Broadcaster will access.
Video UDP Port	Specify the UDP port to be used for streaming the video.
Audio UDP Port	Specify the UDP port to be used for streaming the audio.
Pad to bitrate	If the stream’s bitrate fluctuates you can pad the stream with null packets to create a steady bitrate. This setting determines the padding level in kbps.
Smoothing Latency [ms]	The Smoothing feature uses a buffer to time packets according to the stream’s clock. This is useful when there are bursts in the rate in which the stream arrives. The smoothing features creates a queue in the buffer, allowing smoother entry into the Broadcaster. The Smoothing parameter defines the size of the buffer in Milliseconds. A larger buffer enables smoother entry, however, it may influence the latency rate.
TCP	Select this checkbox for streams that use TCP protocol. Leave unselected in case the stream uses UDP.
Billing Codes	Billing codes are used to identify and differentiate traffic on a Zixi Broadcaster for billing purposes. When a billing code is added to a Source or Target, Zixi can track the traffic on that Broadcaster input or output separately from other inputs and outputs on the same Broadcaster. Billing codes are created by Zixi personnel on the Zixi Customer Portal for a particular organization.
Billing Code	Enter the billing code that corresponds to this stream. The relevant billing can be obtained from the organization that received the billing code from Zixi.
Billing password	Enter the password that corresponds to this billing code.
Enable time shift	Select this checkbox to record the stream content and broadcast it after a specified delay. To deploy an input stream that uses the current stream’s time shift, you need to configure a “Delayed” input stream. (See Adding Delayed Streams).
Maximum delay [hh:mm:ss] (for Time Shift enabled)	Specify the maximum time delay of this input.

Broadcaster Inputs

Adding Input Streams

Enable multicast on pull outputs	Select this checkbox to enable the transmission of this stream's outputs as multicast. A Zixi receiver that will pull the stream will receive it in multicast. By default Zixi Broadcaster is configured to allow transparent fallback to unicast if it is out of the LAN. Requires enabling Multicast Pull in the Settings.
---	--

Multicast Only (for Multicast enabled) Select the check box to force only Multicast outputs.

Enable Encryption	Select this checkbox to encrypt the Input stream. For more information, see Encrypting an Input Stream in Zixi Broadcaster .
--------------------------	--

Encryption type (for Encryption enabled) Specify the type of Encryption (AES 128/192/256).

Encryption key (for Encryption enabled) Click **Generate** to generate an encryption key. The generated encryption key must be sent to the end-user to decipher the received encoded stream.

Recording parameters	Select this checkbox to customize the recording parameters.
-----------------------------	---

Select the radio button for the desired storage type and then fill in the relevant parameters.

- **Record to disk** – the recording is saved on the local disk. It is possible to record to an external destination by replacing the default storage location with a symbolic link. To learn more, see [Using an External Storage](#) section.
- **Record to S3** – the file is saved to your AWS S3 Bucket. The mechanism uses AWS multipart upload. Amazon advises to define a lifetime rule for objects on destination bucket.

Record to Disk Parameters

Specify the file name pattern that Zixi will use to generate when saving the recorded content. A separate file will be generated for each recording up to the time specified in the Max recorded file duration parameter (see above). After this duration a new file will be generated.

File Name Template The file name pattern can include any string and up to five variables listed below. Only the %T=HH.MM.SS creation time is mandatory. You can change the order of these variables and add text as long as you maintain the legitimate structure of the file in Linux and Windows:

- %S=stream id – optional.
 - %Y=year – optional
 - %M=month – optional
-

Broadcaster Inputs

Adding Input Streams

- %D=day – optional
- %T=HH.MM.SS creation time – mandatory
- %U=YYYYmmddTHHMMSSZ UTC timestamp – optional

For example, the following pattern %Y_recording%T.ts will generate the following file name 2017_recording15:32:35.ts.

Max recorded file

duration [HH:MM] Specify the maximum time allotted for recording a video stream. Default: 2 hours

Keep recorded files for [HH:MM]

Specify the maximum time for storing the recording. Default: 0 hours

Custom Path

Optionally specify a storage location for the recorded files that is relative to the root folder. This location bypasses the location specified as the root folder in the **Settings > General** screen.

Record to S3 Parameters

Specify the file name pattern that Zixi will use to generate when saving the recorded content. A separate file will be generated for each recording up to the time specified in the Max recorded file duration parameter (see above). After this duration a new file will be generated.

The file name pattern can include any string and up to five variables listed below. Only the %T=HH.MM.SS creation time is mandatory. You can change the order of these variables and add text as long as you maintain the legitimate structure of the file in Linux and Windows:

File Name Template

- %S=stream id – optional.
- %Y=year – optional
- %M=month – optional
- %D=day – optional
- %T=HH.MM.SS creation time – mandatory

For example, the following pattern %Y_recording%T.ts will generate the following file name 2017_recording15:32:35.ts.

Max recorded file

duration [HH:MM] Specify the maximum time allotted for recording a video stream. Default: 2 hours

URL

Specify the URL of the S3 bucket.

Ignore TLS certificate errors

TLS certificate for S3 bucket might be detected as faulty if bucket name contains dot[s]. When this option is selected, Zixi Broadcaster will ignore the TLS certificate

Broadcaster Inputs

Adding Input Streams

errors and transmit the stream to its destination.

Access Key The access key that is used for accessing the S3 bucket.

Secret Key The secret key that is used for accessing the S3 bucket.

Broadcaster Inputs

Adding Input Streams

Adding HLS Streams

This screen enables the Broadcaster to receive an HLS stream. The HLS stream is not protected by the Zixi protocol. There are two options for pulling the stream:

- **Single source (adaptive bitrate)** – the stream can be an adaptive bitrate stream. In this case, Zixi Broadcaster will pull the main playlist to adapt between bitrates according to network conditions.
- **Multiple sources** – it is possible to pull multiple input streams with static individual bitrates. In this case, Zixi Broadcaster will automatically create a separate input for each bitrate.

➔ To Add an HLS stream:

1. In the Zixi Broadcaster Navigation menu, click the **Inputs** tab.
2. In the Menu bar, click **New Input**. The **Add a new input stream** window is displayed.
3. Enter the unique **Stream ID**.



Note: this must be identical (case sensitive) to the stream name configured in ZEC.

4. Enter the maximum concurrent connections to this stream from the **Max. Outputs** drop-down list. Default: Unlimited.
5. Select the **Show in Matrix** check box to display this stream in the Matrix (see [Using the Matrix](#)). Default: Selected.
6. Select **HLS** for the input stream.

The screenshot shows the 'Add new input stream' dialog box. The 'Stream ID' field is empty. 'Max Outputs' is set to 'Unlimited'. 'Show in Matrix' is checked. The 'HLS' radio button is selected among other input types. Under 'Stream parameters', the 'Master playlist URL' is 'http://localhost:7777/input.m3u8' and 'Download type' is 'Multiple sources (pull all bitrates)'. 'Buffering Time [ms]' is set to '30000'. Other options like 'Inject SCTE35 on CUE marks', 'Support EXT-X-DATERANGE', 'Start from last segment', 'Zixi broadcaster', and 'Use HTTP parameters for substreams' are unchecked. There are also sections for 'Billing Codes', 'Enable time shift', 'Enable multicast on pull outputs', 'Enable encryption', and 'Recording parameters', all with unchecked checkboxes. 'Ok' and 'Cancel' buttons are at the bottom right.

7. Specify the **Stream Parameters** (see Input Stream Parameters Table below).
8. If you want to specify **Billing Codes** to identify and differentiate traffic on a Zixi Broadcaster for billing purposes, select this checkbox (see Input Stream Parameter Table below).

Broadcaster Inputs

Adding Input Streams

9. If you want to **Enable time shift**, select this checkbox (see Input Stream Parameters Table).
10. If you want to **Enable multicast on pull outputs**, select this checkbox (see Input Stream Parameters Table).
11. If you want to **Enable encryption**, select this checkbox (see Input Stream Parameters Table).
12. If you want to configure the **Recording Parameters**, specify them in the respective fields (see Input Stream Parameters Table).
13. Click **OK**.

The “Input added” message appears on the top of the screen. The HLS stream from ZEC is added to the Zixi Broadcaster and now appears in the list of streams available in the Zixi Broadcaster inputs UI. If the “multiple sources” option was select, Zixi Broadcaster will automatically create a separate input for each bitrate.

Input Stream Parameters Table

Parameter	Description
Stream Parameters	
Master Playlist URL	Specify the URL of the HLS stream.
Download Type	Specify whether the variants will be pulled from a single source (adaptive bitrate) or multiple sources (pull all bitrates).
Buffering Time [ms]	Specify a buffer time to time packets according to the stream’s clock. This is useful when there are bursts in the rate in which the stream arrives. This feature creates a queue in the buffer, allowing smoother entry into the Broadcaster. The Buffer Time parameter defines the size of the buffer in Milliseconds. A larger buffer enables smoother entry, however, it may influence the latency rate.
Inject SCTE35 on CUE Marks	Select this checkbox to inject SCTE markers into the adaptive stream manifest. SCTE-35 markers found in the source input will be used to segment the stream and the #EXT-X-CUE-IN/#EXT-X-CUE-OUT tags will be added to the manifest.
Support EXT-X-DATERANGE	EXT-X-DATERANGE is a way of providing timed metadata in an HLS manifest. It is used to define date range metadata in a media playlist. A possible use case is defining timed metadata for interstitial regions such as advertisements, but can be used to define any timed metadata needed by your stream. Select this checkbox to enable this feature.
Start from last segment	Select this checkbox to begin downloading from the last segment in the playlist. By selecting this mode, you may lose the previous data in the playlist (i.e., the chunks before the last chunks will not be downloaded), however you will enjoy lower latency.

Broadcaster Inputs

Adding Input Streams

Zixi Broadcaster	Select this checkbox if you are pulling the HLS from a Zixi Broadcaster. This will add a parameter in the request to pull the stream so that the origin Zixi Broadcaster can identify the puller and show a single output in the outputs table. If you don't select this option, the origin Zixi Broadcaster will display a different output for each downloaded segment.
Use HTTP parameters for substreams	If your Master URL has HTTP parameters (e.g., http://server.com/main.m3u8?user=someuser&password=somepass&etc=...), the parameters will be propagated as subplaylists and chunks. For example, the master playlist will have a subplaylist: sub_playlist1.m3u8 In this case, the request for this playlist will be: http://server.com/sub_playlist1.m3u8?user=someuser&password=somepass&etc=...
Billing Codes	Billing codes are used to identify and differentiate traffic on a Zixi Broadcaster for billing purposes. When a billing code is added to a Source or Target, Zixi can track the traffic on that Broadcaster input or output separately from other inputs and outputs on the same Broadcaster. Billing codes are created by Zixi personnel on the Zixi Customer Portal for a particular organization.
Billing Code	Enter the billing code that corresponds to this stream. The relevant billing can be obtained from the organization that received the billing code from Zixi.
Billing password	Enter the password that corresponds to this billing code.
Enable time shift	Select this checkbox to record the stream content and broadcast it after a specified delay. To deploy an input stream that uses the current stream's time shift, you need to configure a "Delayed" input stream. (See Adding Delayed Streams).
Maximum delay [hh:mm:ss] (for Time Shift enabled)	Specify the maximum time delay of this input.
Enable multicast on pull outputs	Select this checkbox to enable the transmission of this stream's outputs as multicast. A Zixi receiver that will pull the stream will receive it in multicast. By default, Zixi Broadcaster is configured to allow transparent fallback to unicast if it is out of the LAN. Requires enabling Multicast Pull in the Settings.
Multicast Only (for Multicast enabled)	If desired, specify multicast only outputs.
Enable Encryption	Select this checkbox to encrypt the Input stream. For more information, see Encrypting an Input Stream in Zixi Broadcaster .

Broadcaster Inputs

Adding Input Streams

Encryption type (for Encryption enabled) Specify the type of Encryption (AES 128/192/256).

Encryption key (for Encryption enabled) Click **Generate** to generate an encryption key. The generated encryption key must be sent to the end-user to decipher the received encoded stream.

Recording parameters Select this checkbox to customize the recording parameters.

Select the radio button for the desired storage type and then fill in the relevant parameters.

Destination Type

- **Record to disk** – the recording is saved on the local disk. It is possible to record to an external destination by replacing the default storage location with a symbolic link. To learn more, see [Using an External Storage](#) section.
- **Record to S3** – the file is saved to your AWS S3 Bucket. The mechanism uses AWS multipart upload. Amazon advises to define a lifetime rule for objects on destination bucket.

Record to Disk Parameters

Specify the file name pattern that Zixi will use to generate when saving the recorded content. A separate file will be generated for each recording up to the time specified in the Max recorded file duration parameter (see above). After this duration a new file will be generated.

The file name pattern can include any string and up to five variables listed below. Only the %T=HH.MM.SS creation time is mandatory. You can change the order of these variables and add text as long as you maintain the legitimate structure of the file in Linux and Windows:

- File Name Template**
- %S=stream id – optional.
 - %Y=year – optional
 - %M=month – optional
 - %D=day – optional
 - %T=HH.MM.SS creation time – mandatory
 - %U=YYYYmddTHHMMSSZ UTC timestamp – optional

For example, the following pattern %Y_recording%T.ts will generate the following file name 2017_recording15:32:35.ts.

Max Specify the maximum time allotted for recording a video stream. Default: 2 hours

Broadcaster Inputs

Adding Input Streams

recorded file

duration

[HH:MM]

Keep

recorded

files for

[HH:MM]

Specify the maximum time for storing the recording. Default: 0 hours

Custom Path

Optionally specify a storage location for the recorded files that is relative to the root folder. This location bypasses the location specified as the root folder in the **Settings > General** screen.

Record to S3

Parameters

Specify the file name pattern that Zixi will use to generate when saving the recorded content. A separate file will be generated for each recording up to the time specified in the Max recorded file duration parameter (see above). After this duration a new file will be generated.

The file name pattern can include any string and up to five variables listed below. Only the %T=HH.MM.SS creation time is mandatory. You can change the order of these variables and add text as long as you maintain the legitimate structure of the file in Linux and Windows:

File Name
Template

- %S=stream id – optional.
- %Y=year – optional
- %M=month – optional
- %D=day – optional
- %T=HH.MM.SS creation time – mandatory
- %U=YYYYmmddTHHMMSSZ UTC timestamp – optional

For example, the following pattern %Y_recording%T.ts will generate the following file name 2017_recording15:32:35.ts.

Max

recorded file

duration

[HH:MM]

Specify the maximum time allotted for recording a video stream. Default: 2 hours

URL

Specify the URL of the S3 bucket.

Ignore TLS
certificate
errors

TLS certificate for S3 bucket might be detected as faulty if bucket name contains dot[s]. When this option is selected, Zixi Broadcaster will ignore the TLS certificate errors and transmit the stream to its destination.

Access Key

The access key that is used for accessing the S3 bucket.

Broadcaster Inputs

Adding Input Streams

Secret Key The secret key that is used for accessing the S3 bucket.

Adding TS over HTTP (Pull) Streams

In this mode Zixi Broadcaster pulls a Transport Stream over TCP from an HTTP server. In this case, the stream is initiated by your Zixi Broadcaster.

➔ To Add a TS over HTTP (Pull) Stream:

1. In the Zixi Broadcaster navigation menu, click the **Inputs** tab.
2. In the Menu bar, click **New Input**. The **Add a new input stream** window is displayed.
3. Enter the unique **Stream ID**.



Note: this must be identical (case sensitive) to the stream name configured in the source.

4. Select the maximum concurrent connections to this stream from the **Max. Outputs** drop-down list. Default: Unlimited.
5. Select the **Show in Matrix** checkbox to display this stream in the Matrix (see [Using the Matrix](#)). Default: Selected.
6. Select **TS over HTTP** for the input stream.
7. In the **Type** field, select **Pull**.

The screenshot shows the 'Add new input stream' dialog box. The 'Stream ID' field is empty. 'Max Outputs' is set to 'Unlimited' and 'Show in Matrix' is checked. The 'Type' dropdown is set to 'Pull'. The 'URL (http://host:[port]/stream):' field contains 'http://localhost:7777/input.ts' and 'Smoothing [ms]:' is set to '1000'. There are checkboxes for 'Billing Codes', 'Enable time shift', 'Enable multicast on pull outputs', 'Enable encryption', and 'Recording parameters'. 'Ok' and 'Cancel' buttons are at the bottom right.

8. Specify the **Stream Parameters** (see Input Stream Parameter table).
9. If you want to specify **Billing Codes** to identify and differentiate traffic on a Zixi Broadcaster for billing purposes, select this checkbox (see Input Stream Parameter Table below).
10. If you want to **Enable time shift**, select this checkbox (see Input Stream Parameter table). The stream will be recorded and broadcasted after the specified delay. The time shift feature is typically used to broadcast a live event across time zones (due to the time differences between locations).
11. If you want to **Enable multicast on pull outputs**, select this checkbox (see Input Stream Parameter table).

Broadcaster Inputs

Adding Input Streams

12. If you want to **Enable encryption**, select this checkbox (see Input Stream Parameters Table).
13. If you want to configure the **Recording Parameters**, specify them in the respective fields (see Input Stream Parameter table).
14. Click **OK**.

Input Stream Parameters table

Parameter	Description
Stream Parameters	The general stream settings.
URL	Enter the URL of the Transport Stream.
Smoothing	The Smoothing feature uses a buffer to time packets according to the stream's clock. This is useful when there are bursts in the rate in which the stream arrives. The smoothing features creates a queue in the buffer, allowing smoother entry into the Broadcaster. The Smoothing parameter defines the size of the buffer in Milliseconds. A larger the buffer enables smoother entry. However, it may influence the latency rate.
Billing Codes	Billing codes are used to identify and differentiate traffic on a Zixi Broadcaster for billing purposes. When a billing code is added to a Source or Target, Zixi can track the traffic on that Broadcaster input or output separately from other inputs and outputs on the same Broadcaster. Billing codes are created by Zixi personnel on the Zixi Customer Portal for a particular organization.
Billing Code	Enter the billing code that corresponds to this stream. The relevant billing can be obtained from the organization that received the billing code from Zixi.
Billing password	Enter the password that corresponds to this billing code.
Enable time shift	Select this checkbox to record the stream content and broadcast it after a specified delay. To deploy an input stream that uses the current stream's time shift, you need to configure a "Delayed" input stream. (See Adding Delayed Streams).
Maximum delay [hh:mm:ss] (for Time Shift enabled)	Specify the time of a delayed transmission of this stream. Maximum: 24 hours
Enable multicast on pull outputs	Select this checkbox to enable the transmission of this stream's outputs as multicast. A Zixi Broadcaster that will pull the stream will receive it in multicast. By default, Zixi Broadcaster is configured to allow transparent fallback to unicast if it is out of the LAN. Requires enabling Multicast Pull in the Settings .

Broadcaster Inputs

Adding Input Streams

**Multicast-Only
(for multicast
enabled)** If desired, specify multicast-only outputs.

Enable Encryption Select this checkbox to encrypt the Input stream. For more information, see [Encrypting an Input Stream in Zixi Broadcaster](#).

**Encryption type
(for Encryption
enabled)** Specify the type of Encryption (AES 128/192/256).

**Encryption key
(for Encryption
enabled)** Click Generate to generate an encryption key. The generated encryption key must be sent to the end-user to decipher the received encoded stream.

**Recording
parameters** Select this checkbox to customize the recording parameters.

Select the radio button for the desired storage type and then fill in the relevant parameters.

Destination Type

- **Record to disk** – the recording is saved on the local disk. It is possible to record to an external destination by replacing the default storage location with a symbolic link. To learn more, see [Using an External Storage](#) section.
- **Record to S3** – the file is saved to your AWS S3 Bucket. The mechanism uses AWS multipart upload. Amazon advises to define a lifetime rule for objects on destination bucket.

**Record to Disk
Parameters**

Broadcaster Inputs

Adding Input Streams

File Name Template	<p>Specify the file name pattern that Zixi will use to generate when saving the recorded content. A separate file will be generated for each recording up to the time specified in the Max recorded file duration parameter (see above). After this duration a new file will be generated.</p> <p>The file name pattern can include any string and up to five variables listed below. Only the %T=HH.MM.SS creation time is mandatory. You can change the order of these variables and add text as long as you maintain the legitimate structure of the file in Linux and Windows:</p> <ul style="list-style-type: none">• %S=stream id – optional.• %Y=year – optional• %M=month – optional• %D=day – optional• %T=HH.MM.SS creation time – mandatory• %U=YYYYmmddTHHMMSSZ UTC timestamp – optional <p>For example, the following pattern %Y_recording%T.ts will generate the following file name 2017_recording15:32:35.ts.</p>
Max recorded file duration [HH:MM]	Specify the maximum time allotted for recording a video stream. Default: 2 hours
Keep recorded files for [HH:MM]	Specify the maximum time for storing the recording. Default: 0 hours
Custom Path	Optionally specify a storage location for the recorded files that is relative to the root folder. This location bypasses the location specified as the root folder in the Settings > General screen.
Record to S3 Parameters	

Broadcaster Inputs

Adding Input Streams

File Name Template	<p>Specify the file name pattern that Zixi will use to generate when saving the recorded content. A separate file will be generated for each recording up to the time specified in the Max recorded file duration parameter (see above). After this duration a new file will be generated.</p> <p>The file name pattern can include any string and up to five variables listed below. Only the %T=HH.MM.SS creation time is mandatory. You can change the order of these variables and add text as long as you maintain the legitimate structure of the file in Linux and Windows:</p> <ul style="list-style-type: none">• %S=stream id – optional.• %Y=year – optional• %M=month – optional• %D=day – optional• %T=HH.MM.SS creation time – mandatory• %U=YYYYmmddTHHMMSSZ UTC timestamp – optional <p>For example, the following pattern %Y_recording%T.ts will generate the following file name 2017_recording15:32:35.ts.</p>
Max recorded file duration [hours]	Specify the maximum time allotted for recording a video stream. Default: 2 hours
URL	Specify the URL of the S3 bucket.
Ignore TLS certificate errors	TLS certificate for S3 bucket might be detected as faulty if bucket name contains dot[s]. When this option is selected, Zixi Broadcaster will ignore the TLS certificate errors and transmit the stream to its destination.
Access Key	The access key that is used for accessing the S3 bucket.
Secret Key	The secret key that is used for accessing the S3 bucket.

Adding TS over HTTP (Push) Streams

In this mode Zixi Broadcaster will receive a Transport Stream over TCP from an HTTP server. In this case, the stream is initiated by the source HTTP Server, while the Zixi Broadcaster remains in “listening mode” until the stream (with the specified stream ID) is initiated.

➔ To Add a TS over HTTP (Push) Stream:

1. In the Zixi Broadcaster Navigation menu, click the **Inputs** tab.
2. In the **Menu** bar, click **New Input**. The **Add a new input stream** window is displayed.
3. Enter the unique **Stream ID** for the Broadcaster.



ZEC.

Note: this must be identical (case sensitive) to the stream name configured in

Broadcaster Inputs

Adding Input Streams

4. Select the maximum concurrent connections to this stream from the **Max. Outputs** drop-down list. Default: Unlimited.
5. Select the **Show in Matrix** checkbox to display this stream in the Matrix (see [Using the Matrix](#)). Default: Selected.
6. Select **TS over HTTP** for the input stream
7. In the **Type** field, select **Push**.

The screenshot shows the 'Add new input stream' dialog box. At the top, there are fields for 'Stream ID', 'Max Outputs' (set to 'Unlimited'), and 'Show in Matrix' (checked). Below these is a row of radio buttons for selecting the input stream type: Push, Pull, UDP, Delayed, File, RTMP, RTSP, HLS, TS over HTTP (selected), SRT, SRT Client, RIST, NDI, WebRTC, File over HTTP, and Multiplex. Underneath is a 'Stream parameters' section with a 'Type' dropdown (Push selected), a 'Smoothing (ms)' input field (1000), and 'User' and 'Password' input fields. There are also several checkboxes: 'Billing Codes', 'Enable time shift', 'Enable multicast on pull outputs', 'Enable encryption', and 'Recording parameters'. At the bottom right, there are 'Ok' and 'Cancel' buttons.

8. Specify the **Stream Parameters** (see Input Stream Parameters Table below).
9. If you want to specify **Billing Codes** to identify and differentiate traffic on a Zixi Broadcaster for billing purposes, select this checkbox (see Input Stream Parameter Table below).
10. If you want to **Enable time shift**, select this checkbox (see Input Stream Parameter Table below). The stream will be recorded and broadcasted after the specified delay. The time shift feature is typically used to broadcast a live event across time zones (due to the time differences between locations).
11. If you want to **Enable multicast on pull outputs**, select this checkbox (see Input Stream Parameter Table).
12. If you want to **Enable encryption**, select this checkbox (see Input Stream Parameters Table).
13. If you want to record the stream, you can configure the **Recording Parameters** (see Input Stream Parameter Table).
14. Click **OK**.

Broadcaster Inputs

Adding Input Streams

Input Stream Parameters Table

Parameter	Description
Stream Parameters	
Smoothing	The Smoothing feature uses a buffer to time packets according to the stream's clock. This is useful when there are bursts in the rate in which the stream arrives. The smoothing features creates a queue in the buffer, allowing smoother entry into the Broadcaster. The Smoothing parameter defines the size of the buffer in Milliseconds. A larger buffer enables smoother entry, however, it may influence the latency rate.
User	If the stream is password protected, enter the username to access the stream.
Password	If the stream is password protected, enter the password.
Billing Codes	Billing codes are used to identify and differentiate traffic on a Zixi Broadcaster for billing purposes. When a billing code is added to a Source or Target, Zixi can track the traffic on that Broadcaster input or output separately from other inputs and outputs on the same Broadcaster. Billing codes are created by Zixi personnel on the Zixi Customer Portal for a particular organization.
Billing Code	Enter the billing code that corresponds to this stream. The relevant billing can be obtained from the organization that received the billing code from Zixi.
Billing password	Enter the password that corresponds to this billing code.
Enable time shift	Select this checkbox to record the stream content and broadcast it after a specified delay. To deploy an input stream that uses the current stream's time shift, you need to configure a "Delayed" input stream. (See Adding Delayed Streams).
Maximum delay [hh:mm:ss]	Specify the time of the delayed transmission of this stream. Maximum: 24 hours.
Enable multicast on pull outputs	Select this checkbox to enable the transmission of this stream's outputs as multicast. A Zixi receiver that will pull the stream will receive it in multicast. By default, Zixi Broadcaster is configured to allow transparent fallback to unicast if it is out of the LAN. Requires enabling Multicast Pull in the Settings .
Multicast Only	Selecting this checkbox will force the transmission of this stream only in multicast.
Enable Encryption	Select this checkbox to encrypt the Input stream. For more information, see Encrypting an Input Stream in Zixi Broadcaster .
Encryption type (for Encryption enabled)	Specify the type of Encryption (AES 128/192/256).

Broadcaster Inputs

Adding Input Streams

Encryption key (for Encryption enabled) Click Generate to generate an encryption key. The generated encryption key must be sent to the end-user to decipher the received encoded stream.

Recording parameters Select this checkbox to customize the recording parameters.

Select the radio button for the desired storage type and then fill in the relevant parameters.

Destination Type

- **Record to disk** – the recording is saved on the local disk. It is possible to record to an external destination by replacing the default storage location with a symbolic link. To learn more, see [Using an External Storage](#) section.
- **Record to S3** – the file is saved to your AWS S3 Bucket. The mechanism uses AWS multipart upload. Amazon advises to define a lifetime rule for objects on destination bucket.

Record to Disk Parameters

Specify the file name pattern that Zixi will use to generate when saving the recorded content. A separate file will be generated for each recording up to the time specified in the Max recorded file duration parameter (see above). After this duration a new file will be generated.

The file name pattern can include any string and up to five variables listed below. Only the %T=HH.MM.SS creation time is mandatory. You can change the order of these variables and add text as long as you maintain the legitimate structure of the file in Linux and Windows:

- File Name Template**
- %S=stream id – optional.
 - %Y=year – optional
 - %M=month – optional
 - %D=day – optional
 - %T=HH.MM.SS creation time – mandatory
 - %U=YYYYmddTHHMMSSZ UTC timestamp – optional

For example, the following pattern %Y_recording%T.ts will generate the following file name 2017_recording15:32:35.ts.

Max recorded file duration [HH:MM] Specify the maximum time allotted for recording a video stream. Default: 2 hours

Keep recorded files for [HH:MM] Specify the maximum time for storing the recording. Default: 0 hours

Broadcaster Inputs

Adding Input Streams

Custom Path	Optionally specify a storage location for the recorded files that is relative to the root folder. This location bypasses the location specified as the root folder in the Settings > General screen.
Record to S3 Parameters	
File Name Template	<p>Specify the file name pattern that Zixi will use to generate when saving the recorded content. A separate file will be generated for each recording up to the time specified in the Max recorded file duration parameter (see above). After this duration a new file will be generated.</p> <p>The file name pattern can include any string and up to five variables listed below. Only the %T=HH.MM.SS creation time is mandatory. You can change the order of these variables and add text as long as you maintain the legitimate structure of the file in Linux and Windows:</p> <ul style="list-style-type: none">• %S=stream id – optional.• %Y=year – optional• %M=month – optional• %D=day – optional• %T=HH.MM.SS creation time – mandatory• %U=YYYYmmddTHHMMSSZ UTC timestamp – optional <p>For example, the following pattern %Y_recording%T.ts will generate the following file name 2017_recording15:32:35.ts.</p>
Max recorded file duration [HH:MM]	Specify the maximum time allotted for recording a video stream. Default: 2 hours
URL	Specify the URL of the S3 bucket.
Ignore TLS certificate errors	TLS certificate for S3 bucket might be detected as faulty if bucket name contains dot[s]. When this option is selected, Zixi Broadcaster will ignore the TLS certificate errors and transmit the stream to its destination.
Access Key	The access key that is used for accessing the S3 bucket.
Secret Key	The secret key that is used for accessing the S3 bucket.

Adding SRT Streams

SRT (Secure Reliable Transport) is an open-source video streaming protocol that brings pristine quality, low-latency live video over the public internet. This input enables the Broadcaster to receive an SRT stream. The source of the stream is an SRT client that pushes the stream into Zixi Broadcaster. The connection is initiated by the source SRT client, which connects to the Listening Port on the Zixi Broadcaster. The connection can be password protected.

Broadcaster Inputs

Adding Input Streams

More details about SRT can be found at <https://www.haivision.com/products/srt-secure-reliable-transport/>

➔ To Add a SRT Stream:

1. In the Zixi Broadcaster Navigation menu, click the **Inputs** tab.
2. In the Menu bar, click **New Input**. The **Add a new input stream** window is displayed.
3. Enter the unique **Stream ID**.



Note this must be identical (case sensitive) to the stream name configured at the source.

4. Select the maximum concurrent connections to this stream from the **Max. Outputs** drop-down list. Default: Unlimited.
5. Select the **Show in Matrix** check box to display this stream in the Matrix (see [Using the Matrix](#)). Default: Selected.
6. Select **SRT** for the input stream.

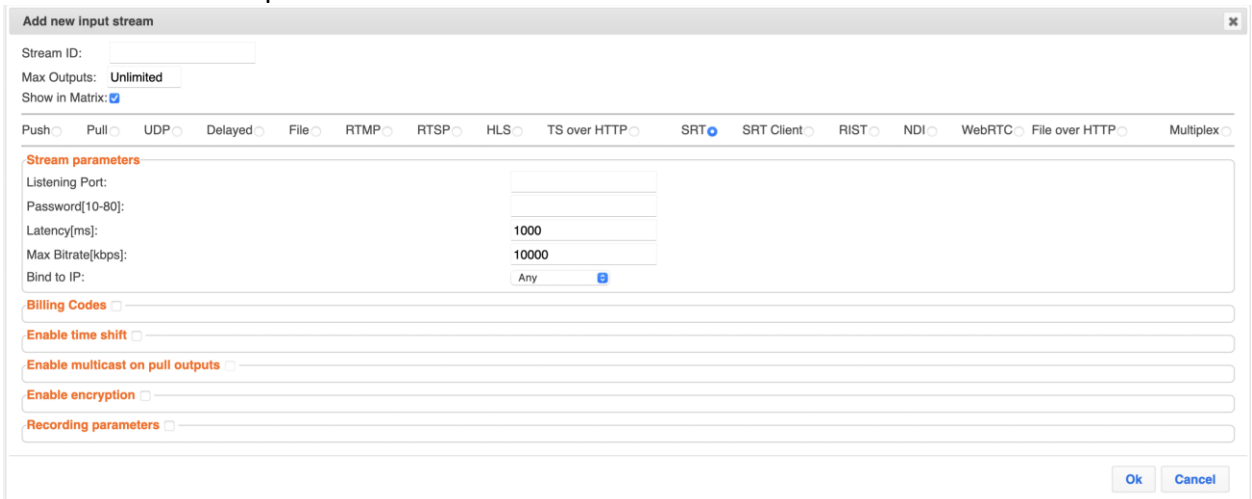

7. Specify the **Stream Parameters** (see Input Stream Parameters Table).
8. If you want to specify **Billing Codes** to identify and differentiate traffic on a Zixi Broadcaster for billing purposes, select this checkbox (see Input Stream Parameter Table below).
9. If you want to **Enable time shift**, select this checkbox (see Input Stream Parameters Table).
10. If you want to **Enable multicast on pull outputs**, select this checkbox (see Input Stream Parameters Table).
11. If you want to **Enable encryption**, select this checkbox (see Input Stream Parameters Table). For more information, see **Encrypting an Input Stream in Zixi Broadcaster**.
12. If you want to configure the **Recording Parameters**, specify them in the respective fields (see Input Stream Parameters Table).
13. Click **OK**.
The “Input added” message appears on the top of the screen. The SRT Stream is added

Broadcaster Inputs

Adding Input Streams

to the Zixi Broadcaster and now appears in the list of streams available in the Zixi Broadcaster inputs UI.

Input Stream Parameters Table

Parameter	Description
Stream Parameters	
Listening Port	Specify the port to listen on. This port must be open on all firewalls between the Zixi Broadcaster and other devices it is communicating with.
Password	If the stream is password protected, enter the password.
Latency	Specify the maximum latency of the stream in milliseconds. Default: 1000
Max. bitrate [kbps]	Specify the maximum expected bitrate for memory allocation. Recommended: 2X the actual bitrate, which will prevent buffer overruns (especially with VBR streams). Default: 8000. Note – Overflows will typically occur when the Max Bitrate isn't sufficient.
Billing Codes	Billing codes are used to identify and differentiate traffic on a Zixi Broadcaster for billing purposes. When a billing code is added to a Source or Target, Zixi can track the traffic on that Broadcaster input or output separately from other inputs and outputs on the same Broadcaster. Billing codes are created by Zixi personnel on the Zixi Customer Portal for a particular organization.
Billing Code	Enter the billing code that corresponds to this stream. The relevant billing can be obtained from the organization that received the billing code from Zixi.
Billing password	Enter the password that corresponds to this billing code.
Enable time shift	Select this checkbox to record the stream content and broadcast it after a specified delay. To deploy an input stream that uses the current stream's time shift, you need to configure a "Delayed" input stream. (See Adding Delayed Streams).
Maximum delay [hh:mm:ss] (for Time Shift enabled)	Specify the maximum time delay of this input.
Enable multicast on pull outputs	Select this checkbox to enable the transmission of this stream's outputs as multicast. A Zixi receiver that will pull the stream will receive it in multicast. By default Zixi Broadcaster is configured to allow transparent fallback to unicast if it is out of the LAN. Requires enabling Multicast Pull in the Settings.

Broadcaster Inputs

Adding Input Streams

Multicast-Only (for multicast enabled) Selecting this checkbox will force the transmission of this stream only in multicast.

Enable Encryption Select this checkbox to encrypt the Input stream. For more information, see [Encrypting an Input Stream in Zixi Broadcaster](#).

Encryption type (for Encryption enabled) Specify the type of Encryption (AES 128/192/256).

Encryption key (for Encryption enabled) Click **Generate** to generate an encryption key. The generated encryption key must be sent to the end-user to decipher the received encoded stream.

Recording parameters Select this checkbox to customize the recording parameters.

Select the radio button for the desired storage type and then fill in the relevant parameters.

Destination Type

- **Record to disk** – the recording is saved on the local disk. It is possible to record to an external destination by replacing the default storage location with a symbolic link. To learn more, see [Using an External Storage](#) section.
- **Record to S3** – the file is saved to your AWS S3 Bucket. The mechanism uses AWS multipart upload. Amazon advises to define a lifetime rule for objects on destination bucket.

Record to Disk Parameters

Broadcaster Inputs

Adding Input Streams

File Name Template	<p>Specify the file name pattern that Zixi will use to generate when saving the recorded content. A separate file will be generated for each recording up to the time specified in the Max recorded file duration parameter (see above). After this duration a new file will be generated.</p> <p>The file name pattern can include any string and up to five variables listed below. Only the %T=HH.MM.SS creation time is mandatory. You can change the order of these variables and add text as long as you maintain the legitimate structure of the file in Linux and Windows:</p> <ul style="list-style-type: none">• %S=stream id – optional.• %Y=year – optional• %M=month – optional• %D=day – optional• %T=HH.MM.SS creation time – mandatory• %U=YYYYmmddTHHMMSSZ UTC timestamp – optional <p>For example, the following pattern %Y_recording%T.ts will generate the following file name 2017_recording15:32:35.ts.</p>
Max recorded file duration [HH:MM]	Specify the maximum time allotted for recording a video stream. Default: 2 hours
Keep recorded files for [HH:MM]	Specify the maximum time for storing the recording. Default: 0 hours
Custom Path	Optionally specify a storage location for the recorded files that is relative to the root folder. This location bypasses the location specified as the root folder in the Settings > General screen.
Record to S3 Parameters	

Broadcaster Inputs

Adding Input Streams

File Name Template	<p>Specify the file name pattern that Zixi will use to generate when saving the recorded content. A separate file will be generated for each recording up to the time specified in the Max recorded file duration parameter (see above). After this duration a new file will be generated.</p> <p>The file name pattern can include any string and up to five variables listed below. Only the %T=HH.MM.SS creation time is mandatory. You can change the order of these variables and add text as long as you maintain the legitimate structure of the file in Linux and Windows:</p> <ul style="list-style-type: none">• %S=stream id – optional.• %Y=year – optional• %M=month – optional• %D=day – optional• %T=HH.MM.SS creation time – mandatory• %U=YYYYmmddTHHMMSSZ UTC timestamp – optional <p>For example, the following pattern %Y_recording%T.ts will generate the following file name 2017_recording15:32:35.ts.</p>
Max recorded file duration [HH:MM]	Specify the maximum time allotted for recording a video stream. Default: 2 hours
URL	Specify the URL of the S3 bucket.
Ignore TLS certificate errors	TLS certificate for S3 bucket might be detected as faulty if bucket name contains dot[s]. When this option is selected, Zixi Broadcaster will ignore the TLS certificate errors and transmit the stream to its destination.
Access Key	The access key that is used for accessing the S3 bucket.
Secret Key	The secret key that is used for accessing the S3 bucket.

Broadcaster Inputs

Adding Input Streams

Adding SRT Client Streams

SRT (Secure Reliable Transport) is an open-source video streaming protocol that brings pristine quality, low-latency live video over the public internet. This input enables the Broadcaster to pull an SRT stream from the source. The connection is initiated by Zixi Broadcaster. The connection can be password protected.

More details about SRT can be found at <https://www.haivision.com/products/srt-secure-reliable-transport/>

➔ To Add a SRT Client Stream:

1. In the Zixi Broadcaster Navigation menu, click the **Inputs** tab.
2. In the Menu bar, click **New Input**. The **Add a new input stream** window is displayed.
3. Enter the unique **Stream ID**.



Note this must be identical (case sensitive) to the stream name configured at the source.

4. Select the maximum concurrent connections to this stream from the **Max. Outputs** drop-down list. Default: Unlimited.
5. Select the **Show in Matrix** check box to display this stream in the Matrix (see [Using the Matrix](#)). Default: Selected.
6. Select **SRT Client** for the input stream.

The screenshot shows the 'Add new input stream' dialog box. The 'Stream ID' field is empty. 'Max Outputs' is set to 'Unlimited'. 'Show in Matrix' is checked. The 'SRT Client' radio button is selected. The 'Stream parameters' section includes fields for Host, Port, Password, Latency (1000), Max Bitrate (10000), and Bind to IP (Any). There are also checkboxes for Billing Codes, Enable time shift, Enable multicast on pull outputs, Enable encryption, and Recording parameters. 'Ok' and 'Cancel' buttons are at the bottom right.

7. Specify the **Stream Parameters** (see Input Stream Parameters Table).
8. If you want to specify **Billing Codes** to identify and differentiate traffic on a Zixi Broadcaster for billing purposes, select this checkbox (see Input Stream Parameter Table below).
9. If you want to **Enable time shift**, select this checkbox (see Input Stream Parameters Table).

Broadcaster Inputs

Adding Input Streams

10. If you want to **Enable multicast on pull outputs**, select this checkbox (see Input Stream Parameters Table).
11. If you want to **Enable encryption**, select this checkbox (see Input Stream Parameters Table). For more information, see **Encrypting an Input Stream in Zixi Broadcaster**.
12. If you want to configure the **Recording Parameters**, specify them in the respective fields (see Input Stream Parameters Table).
13. Click **OK**.

The “Input added” message appears on the top of the screen. The SRT Client Stream f is added to the Zixi Broadcaster and now appears in the list of streams available in the Zixi Broadcaster inputs UI.

Input Stream Parameters Table

Parameter	Description
Stream Parameters	
Host	Enter the IP Address of the remote server from which the SRT stream will be pulled.
Port	Enter the port through which the Broadcaster receives the stream from another server. Default: 2088 The default input port for Zixi Broadcaster is UDP port 2088 . This port <i>must be open</i> on any firewalls between Zixi Broadcaster and other devices it is communicating with.
Password	If the stream is password protected, enter the password.
Latency	Specify the maximum latency of the stream in milliseconds. Default: 1000
Max. bitrate [kbps]	Specify the maximum expected bitrate for memory allocation. Recommended: 2X the actual bitrate, which will prevent buffer overruns (especially with VBR streams). Default: 8000. Note – Overflows will typically occur when the Max Bitrate isn’t sufficient.
Billing Codes	Billing codes are used to identify and differentiate traffic on a Zixi Broadcaster for billing purposes. When a billing code is added to a Source or Target, Zixi can track the traffic on that Broadcaster input or output separately from other inputs and outputs on the same Broadcaster. Billing codes are created by Zixi personnel on the Zixi Customer Portal for a particular organization.
Billing Code	Enter the billing code that corresponds to this stream. The relevant billing can be obtained from the organization that received the billing code from Zixi.
Billing password	Enter the password that corresponds to this billing code.

Broadcaster Inputs

Adding Input Streams

Enable time shift	Select this checkbox to record the stream content and broadcast it after a specified delay. To deploy an input stream that uses the current stream's time shift, you need to configure a "Delayed" input stream. (See Adding Delayed Streams).
--------------------------	---

Maximum delay [hh:mm:ss] (for Time Shift enabled) Specify the maximum time delay of this input.

Enable multicast on pull outputs	Select this checkbox to enable the transmission of this stream's outputs as multicast. A Zixi receiver that will pull the stream will receive it in multicast. By default Zixi Broadcaster is configured to allow transparent fallback to unicast if it is out of the LAN. Requires enabling Multicast Pull in the Settings.
---	--

Multicast-Only (for multicast enabled) Selecting this checkbox will force the transmission of this stream only in multicast.

Enable Encryption	Select this checkbox to encrypt the Input stream. For more information, see Encrypting an Input Stream in Zixi Broadcaster
--------------------------	--

Encryption type (for Encryption enabled) Specify the type of Encryption (AES 128/192/256).

Encryption key (for Encryption enabled) Click **Generate** to generate an encryption key. The generated encryption key must be sent to the end-user to decipher the received encoded stream.

Recording parameters	Select this checkbox to customize the recording parameters.
-----------------------------	---

Select the radio button for the desired storage type and then fill in the relevant parameters.

- **Record to disk** – the recording is saved on the local disk. It is possible to record to an external destination by replacing the default storage location with a symbolic link. To learn more, see [Using an External Storage](#) section.
- **Record to S3** – the file is saved to your AWS S3 Bucket. The mechanism uses AWS multipart upload. Amazon advises to define a lifetime rule for objects on destination bucket.

Record to Disk Parameters

Broadcaster Inputs

Adding Input Streams

File Name Template	<p>Specify the file name pattern that Zixi will use to generate when saving the recorded content. A separate file will be generated for each recording up to the time specified in the Max recorded file duration parameter (see above). After this duration a new file will be generated.</p> <p>The file name pattern can include any string and up to five variables listed below. Only the %T=HH.MM.SS creation time is mandatory. You can change the order of these variables and add text as long as you maintain the legitimate structure of the file in Linux and Windows:</p> <ul style="list-style-type: none">• %S=stream id – optional.• %Y=year – optional• %M=month – optional• %D=day – optional• %T=HH.MM.SS creation time – mandatory• %U=YYYYmmddTHHMMSSZ UTC timestamp – optional <p>For example, the following pattern %Y_recording%T.ts will generate the following file name 2017_recording15:32:35.ts.</p>
Max recorded file duration [HH:MM]	Specify the maximum time allotted for recording a video stream. Default: 2 hours
Keep recorded files for [HH:MM]	Specify the maximum time for storing the recording. Default: 0 hours
Custom Path	Optionally specify a storage location for the recorded files that is relative to the root folder. This location bypasses the location specified as the root folder in the Settings > General screen.
Record to S3 Parameters	

Broadcaster Inputs

Adding Input Streams

File Name Template	<p>Specify the file name pattern that Zixi will use to generate when saving the recorded content. A separate file will be generated for each recording up to the time specified in the Max recorded file duration parameter (see above). After this duration a new file will be generated.</p> <p>The file name pattern can include any string and up to five variables listed below. Only the %T=HH.MM.SS creation time is mandatory. You can change the order of these variables and add text as long as you maintain the legitimate structure of the file in Linux and Windows:</p> <ul style="list-style-type: none">• %S=stream id – optional.• %Y=year – optional• %M=month – optional• %D=day – optional• %T=HH.MM.SS creation time – mandatory• %U=YYYYmmddTHHMMSSZ UTC timestamp – optional <p>For example, the following pattern %Y_recording%T.ts will generate the following file name 2017_recording15:32:35.ts.</p>
Max recorded file duration [HH:MM]	Specify the maximum time allotted for recording a video stream. Default: 2 hours
URL	Specify the URL of the S3 bucket.
Ignore TLS certificate errors	TLS certificate for S3 bucket might be detected as faulty if bucket name contains dot[s]. When this option is selected, Zixi Broadcaster will ignore the TLS certificate errors and transmit the stream to its destination.
Access Key	The access key that is used for accessing the S3 bucket.
Secret Key	The secret key that is used for accessing the S3 bucket.

Adding RIST Streams

This enables the Broadcaster to receive a RIST stream. RIST seeks to provide reliable, high performance media transport by using UDP at the transport layer to avoid the inefficiencies of TCP, then layering on top Forward Error Correction and Retransmits to add the reliability inherently absent from UDP. Zixi Broadcaster supports RIST streams from any compliant RIST device.

Zixi supports the following RIST profiles:

- **Simple Profile** – The RIST Simple Profile provides best-in-class packet protection, as well as support for multi-link bonding and seamless switching.

Broadcaster Inputs

Adding Input Streams

- **Main Profile** – The RIST Main Profile builds upon the features of the Simple Profile to provide backwards compatibility, while opening the door for additional features, including the use of industry-standard DTLS with a variety of available cyphers to ensure the most up-to-date protection, while being flexible to accommodate local legal regulations. Support for pre-shared keys is also included, which makes RIST Main Profile compatible with one-to-many environments such as satellite or multicast distribution

Contact your Zixi representative to learn more about interoperability testing between Zixi Broadcaster and 3rd party devices. More details about RIST can be found at www.rist.tv

➔ To Add a RIST Stream:

1. In the Zixi Broadcaster Navigation menu, click the **Inputs** tab.
2. In the Menu bar, click **New Input**. The **Add a new input stream** window is displayed.
3. Enter the unique **Stream ID**.



Note this must be identical (case sensitive) to the stream name configured in ZEC).

4. Select the maximum concurrent connections to this stream from the **Max. Outputs** drop-down list. Default: Unlimited.
5. Select the **Show in Matrix** check box to display this stream in the Matrix (see [Using the Matrix](#)). Default: Selected.
6. Select **RIST** for the input stream.

A screenshot of the 'Add new input stream' dialog box in the Zixi Broadcaster interface. The dialog has a title bar 'Add new input stream' with a close button. It contains several input fields: 'Stream ID:' (empty), 'Max Outputs:' (set to 'Unlimited'), and 'Show in Matrix:' (checked). Below these is a horizontal menu of input protocols: Push, Pull, UDP, Delayed, File, RTMP, RTSP, HLS, TS over HTTP, SRT, SRT Client, RIST (selected), NDI, WebRTC, File over HTTP, and Multiplex. The 'Stream parameters' section includes: Profile (Simple Profile), Local Port, Multicast IP, SSM source IP, Remote Port (0=auto) (0), Type (RTP), Bind to IP (Any), Max Bitrate [kbps] (8000), and Max Latency [ms] (1000). At the bottom, there are several unchecked checkboxes: Billing Codes, Enable time shift, Enable multicast on pull outputs, Enable encryption, and Recording parameters. 'Ok' and 'Cancel' buttons are at the bottom right.

7. Specify the **Stream Parameters** (see Input Stream Parameters Table).
8. If you want to specify **Billing Codes** to identify and differentiate traffic on a Zixi Broadcaster for billing purposes, select this checkbox (see Input Stream Parameter Table below).

Broadcaster Inputs

Adding Input Streams

9. If you want to **Enable time shift**, select this checkbox (see Input Stream Parameters Table).
10. If you want to **Enable multicast on pull outputs**, select this checkbox (see Input Stream Parameters Table).
11. If you want to **Enable encryption**, select this checkbox (see Input Stream Parameters Table). For more information, see **Encrypting an Input Stream in Zixi Broadcaster**.
12. If you want to configure the **Recording Parameters**, specify them in the respective fields (see Input Stream Parameters Table).
13. Click **OK**.

The “Input added” message appears on the top of the screen. The RIST Stream is added to the Zixi Broadcaster and now appears in the list of streams available in the Zixi Broadcaster inputs UI.

Input Stream Parameters Table

Parameter	Description
Stream Parameters	
	Select one of the following RIST profiles that matches the input stream:
Profile	<ul style="list-style-type: none">• Simple Profile (default)• Main Profile
Simple Profile Parameters	
Local Port	Specify the port to listen on. This port must be open on all firewalls between the Zixi Broadcaster and other devices it is communicating with.
Multicast IP	If multicast, type the Multicast IP address (or leave blank in the case of Unicast).
SSM Source	Specify the source IP for a source-specific multicast.
Remote Port	Specify the remote port in the source RIST device. Default: 0 (any port)
	Select one of the following protocol types from the drop-down list:
Type	<ul style="list-style-type: none">• RTP• RTP + SMPTE 2022 FEC
Bind to IP	Select from the drop-down list the local IP address to be used for this Input, OR select <i>Any</i> to enable any IP to be used.
Max. bitrate [kbps]	Specify the maximum expected bitrate for memory allocation. Recommended: 2X the actual bitrate, which will prevent buffer overruns (especially with VBR streams). Default: 8000. Note – Overflows will typically occur when the Max Bitrate isn’t sufficient.

Broadcaster Inputs

Adding Input Streams

Max Latency [ms] Specify the maximum latency of the stream in milliseconds. Default: 1000

Main Profile – Push Parameters

Local Port Specify the port to listen on. This port must be open on all firewalls between the Zixi Broadcaster and other devices it is communicating with.

Multicast IP If multicast, type the Multicast IP address (or leave blank in the case of Unicast).

SSM Source Specify the source IP for a source-specific multicast.

Remote Port Specify the remote port in the source RIST device. Default: 0 (any port)

Select one of the following protocol types from the drop-down list:

Type

- RTP
- RTP + SMPTE 2022 FEC

Bind to IP Select from the drop-down list the local IP address to be used for this Input, OR select *Any* to enable any IP to be used.

Max. bitrate [kbps] Specify the maximum expected bitrate for memory allocation. Recommended: 2X the actual bitrate, which will prevent buffer overruns (especially with VBR streams). Default: 8000.
Note – Overflows will typically occur when the Max Bitrate isn't sufficient.

Max Latency [ms] Specify the maximum latency of the stream in milliseconds. Default: 1000

Use DTLS Select this checkbox to encrypt the stream dynamically using DTLS and specify the **User** and **Password**.

Main Profile – Pull Parameters

Remote Host Specify the IP Address of the remote RIST device from which the stream will be pulled.

Remote Port Specify the port of the remote RIST device from which the stream will be pulled. Default: 0 (any port)

Local Port Specify the local port to which the stream will be pulled. Default: 0 (any port)

Select one of the following protocol types from the drop-down list:

Type

- RTP
- RTP + SMPTE 2022 FEC

Bind to IP Select from the drop-down list the local IP address to be used for this Input, OR select *Any* to enable any IP to be used.

Broadcaster Inputs

Adding Input Streams

Max. bitrate [kbps]	Specify the maximum expected bitrate for memory allocation. Recommended: 2X the actual bitrate, which will prevent buffer overruns (especially with VBR streams). Default: 8000. Note – Overflows will typically occur when the Max Bitrate isn't sufficient.
Max Latency [ms]	Specify the maximum latency of the stream in milliseconds. Default: 1000.
Use DTLS	Select this checkbox to encrypt the stream dynamically using DTLS and specify the User and Password .
Ignore TLS certificate errors	When this option is selected, Zixi Broadcaster will ignore the TLS certificate errors and transmit the stream to its destination.
Billing Codes	Billing codes are used to identify and differentiate traffic on a Zixi Broadcaster for billing purposes. When a billing code is added to a Source or Target, Zixi can track the traffic on that Broadcaster input or output separately from other inputs and outputs on the same Broadcaster. Billing codes are created by Zixi personnel on the Zixi Customer Portal for a particular organization.
Billing Code	Enter the billing code that corresponds to this stream. The relevant billing can be obtained from the organization that received the billing code from Zixi.
Billing password	Enter the password that corresponds to this billing code.
Enable time shift	Select this checkbox to record the stream content and broadcast it after a specified delay. To deploy an input stream that uses the current stream's time shift, you need to configure a "Delayed" input stream. (See Adding Delayed Streams).
Maximum delay [hh:mm:ss] (for Time Shift enabled)	Specify the maximum time delay of this input.
Enable multicast on pull outputs	Select this checkbox to enable the transmission of this stream's outputs as multicast. A Zixi receiver that will pull the stream will receive it in multicast. By default Zixi Broadcaster is configured to allow transparent fallback to unicast if it is out of the LAN. Requires enabling Multicast Pull in the Settings.
Multicast-Only (for multicast enabled)	Selecting this checkbox will force the transmission of this stream only in multicast.
Enable Encryption	Select this checkbox to encrypt the Input stream. For more information, see Encrypting an Input Stream in Zixi Broadcaster
Encryption type (for Encryption enabled)	Specify the type of Encryption (AES 128/192/256).

Broadcaster Inputs

Adding Input Streams

Encryption key (for Encryption enabled)	Click Generate to generate an encryption key. The generated encryption key must be sent to the end-user to decipher the received encoded stream.
--	---

Recording parameters	Select this checkbox to customize the recording parameters.
-----------------------------	---

Select the radio button for the desired storage type and then fill in the relevant parameters.

Destination Type

- **Record to disk** – the recording is saved on the local disk. It is possible to record to an external destination by replacing the default storage location with a symbolic link. To learn more, see [Using an External Storage](#) section.
- **Record to S3** – the file is saved to your AWS S3 Bucket. The mechanism uses AWS multipart upload. Amazon advises to define a lifetime rule for objects on destination bucket.

Record to Disk Parameters

Specify the file name pattern that Zixi will use to generate when saving the recorded content. A separate file will be generated for each recording up to the time specified in the Max recorded file duration parameter (see above). After this duration a new file will be generated.

The file name pattern can include any string and up to five variables listed below. Only the %T=HH.MM.SS creation time is mandatory. You can change the order of these variables and add text as long as you maintain the legitimate structure of the file in Linux and Windows:

- File Name Template**
- %S=stream id – optional.
 - %Y=year – optional
 - %M=month – optional
 - %D=day – optional
 - %T=HH.MM.SS creation time – mandatory
 - %U=YYYYmmddTHHMMSSZ UTC timestamp – optional

For example, the following pattern %Y_recording%T.ts will generate the following file name 2017_recording15:32:35.ts.

Max recorded file duration [HH:MM]	Specify the maximum time allotted for recording a video stream. Default: 2 hours
---	--

Keep recorded files for [HH:MM]	Specify the maximum time for storing the recording. Default: 0 hours
--	--

Broadcaster Inputs

Adding Input Streams

Custom Path	Optionally specify a storage location for the recorded files that is relative to the root folder. This location bypasses the location specified as the root folder in the Settings > General screen.
--------------------	--

Record to S3 Parameters

Specify the file name pattern that Zixi will use to generate when saving the recorded content. A separate file will be generated for each recording up to the time specified in the Max recorded file duration parameter (see above). After this duration a new file will be generated.

The file name pattern can include any string and up to five variables listed below. Only the %T=HH.MM.SS creation time is mandatory. You can change the order of these variables and add text as long as you maintain the legitimate structure of the file in Linux and Windows:

File Name Template

- %S=stream id – optional.
- %Y=year – optional
- %M=month – optional
- %D=day – optional
- %T=HH.MM.SS creation time – mandatory
- %U=YYYYmmddTHHMMSSZ UTC timestamp – optional

For example, the following pattern %Y_recording%T.ts will generate the following file name 2017_recording15:32:35.ts.

Max recorded file duration [HH:MM]

Specify the maximum time allotted for recording a video stream. Default: 2 hours

URL

Specify the URL of the S3 bucket.

Ignore TLS certificate errors

TLS certificate for S3 bucket might be detected as faulty if bucket name contains dot[s]. When this option is selected, Zixi Broadcaster will ignore the TLS certificate errors and transmit the stream to its destination.

Access Key

The access key that is used for accessing the S3 bucket.

Secret Key

The secret key that is used for accessing the S3 bucket.

Broadcaster Inputs

Adding Input Streams

Adding NDI Streams

The NDI is pulled into Zixi Broadcaster using the auto-discovery mechanism described in the **NDI Stream Discovery** section.

➔ To Add an NDI Input Stream:



Before adding the NDI Input Stream, you must configure the relevant transcoding profiles – See **Configuring Transcoding Profiles for NDI Sources**.

1. In the Zixi Broadcaster Navigation menu, click the **Inputs** tab.
2. In the Menu bar, click **New Input**. The **Add a new input stream** window is displayed.
3. Select **NDI** for the input stream.

4. Select the maximum concurrent connections to this stream from the **Max. Outputs** drop-down list. Default: Unlimited.
5. Select the **Show in Matrix** check box to display this stream in the Matrix (see [Using the Matrix](#)). Default: Selected.
6. Specify the **Stream Parameters** (see Input Stream Parameter table).
7. If you want to **Enable time shift**, select this checkbox (see Input Stream Parameter table). The stream will be recorded and broadcasted after the specified delay. The time shift feature is typically used to broadcast a live event across time zones (due to the time differences between locations).
8. If you want to **Enable multicast on pull outputs**, select this checkbox (see Input Stream Parameter table).
9. If you want to configure the **Recording Parameters**, specify them in the respective fields (see Input Stream Parameter table).
10. If you want to **Enable encryption**, select this checkbox (see Input Stream Parameters Table). For more information, see [Encrypting an Input Stream in Zixi Broadcaster](#).

Broadcaster Inputs

Adding Input Streams

11. Click **OK**. The “Input added” message appears on the top of the screen. The NDI Stream is added to the Zixi Broadcaster and now appears in the list of streams available in Zixi Broadcaster Inputs screen.

Input Stream Parameters table

Parameter	Description
Stream Parameters	
Stream	Select one of the NDI streams available based on your configuration from the drop-down menu. On a local area network NDI will use the discovery mechanism to advertise the sources and Zixi Broadcaster will automatically discover these streams. To make the streams discoverable in the cloud, you need to deploy an NDI Discovery Server and configure the NDI plug-in with the settings mentioned above.
Video Profile	Select an existing transcoding video profile, or select Remove stream if you want to remove the video track.
Audio Profile	Select an existing transcoding audio profile, or select Remove stream if you want to remove the audio track.
Audio Reference Level [dB]	This parameter attenuates the audio level by the specified level in dB. This setting is used to prevent audio clipping.
Transport Stream Bitrate [kbps]	Specify the bitrate of the transport stream. This parameter is optional. If you do not specify a TS Bitrate, the stream will be VBR. If you specify a bitrate, the stream will be CBR. The bitrate value must be compatible with the selected profile.
Add RTP Headers	Select this checkbox to add RTP headers to the stream. RTP adds a 12-byte header, which includes a sequence number and a timestamp that can be used to detect dropped packets. The sequence number in the RTP headers can be used to do automatic reordering and the timestamps can help overcome inter-packet gaps, also known as IAT (Inter Arrival Time). However, plain RTP does not feature error recovery or error protection. By default, the RTP headers (which include the timestamps and sequences) are being used on the input side, but then they are stripped off and they no longer propagate to outputs.
Use Intel hardware acceleration (if available)	Select this checkbox to use the Intel hardware acceleration component if it available.

Broadcaster Inputs

Adding Input Streams

Smoothing buffer	The Smoothing feature uses a buffer to time packets according to the stream's clock. This is useful when there are bursts in the rate in which the stream arrives. The smoothing feature creates a queue in the buffer, allowing smoother entry into the Broadcaster. The Smoothing parameter defines the size of the buffer in Milliseconds. A larger the buffer enables smoother entry. However, it may influence the latency rate.
Enable time shift	Select this checkbox to record the stream content and broadcast it after a specified delay. To deploy an input stream that uses the current stream's time shift, you need to configure a "Delayed" input stream. (See Adding Delayed Streams).
Maximum delay [hh:mm:ss] (for Time Shift enabled)	Specify the time of a delayed transmission of this stream. Maximum: 24 hours
Enable multicast on pull outputs	Select this checkbox to enable the transmission of this stream's outputs as multicast. A Zixi Broadcaster that will pull the stream will receive it in multicast. By default Zixi Broadcaster is configured to allow transparent fallback to unicast if it is out of the LAN. Requires enabling Multicast Pull in the Settings .
	 This setting can be modified without interrupting an existing stream.
Multicast-Only (for multicast enabled)	If desired, specify multicast-only outputs.
Enable Encryption	Select this checkbox to encrypt the Input stream. For more information, see Encrypting an Input Stream in Zixi Broadcaster .
Encryption type (for Encryption enabled)	Specify the type of Encryption (AES 128/192/256).
Encryption key (for Encryption enabled)	Click Generate to generate an encryption key. The generated encryption key must be sent to the end-user to decipher the received encoded stream.
Recording parameters	Select this checkbox to customize the recording parameters.

Broadcaster Inputs

Adding Input Streams

Destination Type	<p>Select the radio button for the desired storage type and then fill in the relevant parameters.</p> <ul style="list-style-type: none">• Record to disk – the recording is saved on the local disk. It is possible to record to an external destination by replacing the default storage location with a symbolic link. To learn more, see Using an External Storage section.• Record to S3 – the file is saved to your AWS S3 Bucket. The mechanism uses AWS multipart upload. Amazon advises to define a lifetime rule for objects on destination bucket.
-------------------------	---

Record to Disk Parameters

File Name Template	<p>Specify the file name pattern that Zixi will use to generate when saving the recorded content. A separate file will be generated for each recording up to the time specified in the Max recorded file duration parameter (see above). After this duration a new file will be generated.</p> <p>The file name pattern can include any string and up to five variables listed below. Only the %T=HH.MM.SS creation time is mandatory. You can change the order of these variables and add text as long as you maintain the legitimate structure of the file in Linux and Windows:</p> <ul style="list-style-type: none">• %S=stream id – optional.• %Y=year – optional• %M=month – optional• %D=day – optional• %T=HH.MM.SS creation time – mandatory• %U=YYYYmmddTHHMMSSZ UTC timestamp – optional <p>For example, the following pattern %Y_recording%T.ts will generate the following file name 2017_recording15:32:35.ts.</p>
---------------------------	--

Max recorded file duration [HH:MM]	Specify the maximum time allotted for recording a video stream. Default: 2 hours
---	--

Keep recorded files for [HH:MM]	Specify the maximum time for storing the recording. Default: 0 hours
--	--

Custom Path	Optionally specify a storage location for the recorded files that is relative to the root folder. This location bypasses the location specified as the root folder in the Settings > General screen.
--------------------	--

Record to S3 Parameters

Broadcaster Inputs

Adding Input Streams

File Name Template	<p>Specify the file name pattern that Zixi will use to generate when saving the recorded content. A separate file will be generated for each recording up to the time specified in the Max recorded file duration parameter (see above). After this duration a new file will be generated.</p> <p>The file name pattern can include any string and up to five variables listed below. Only the %T=HH.MM.SS creation time is mandatory. You can change the order of these variables and add text as long as you maintain the legitimate structure of the file in Linux and Windows:</p> <ul style="list-style-type: none">• %S=stream id – optional.• %Y=year – optional• %M=month – optional• %D=day – optional• %T=HH.MM.SS creation time – mandatory• %U=YYYYmmddTHHMMSSZ UTC timestamp – optional <p>For example, the following pattern %Y_recording%T.ts will generate the following file name 2017_recording15:32:35.ts.</p>
Max recorded file duration [HH:MM]	Specify the maximum time allotted for recording a video stream. Default: 2 hours
URL	Specify the URL of the S3 bucket.
Ignore TLS certificate errors	TLS certificate for S3 bucket might be detected as faulty if bucket name contains dot[s]. When this option is selected, Zixi Broadcaster will ignore the TLS certificate errors and transmit the stream to its destination.
Access Key	The access key that is used for accessing the S3 bucket.
Secret Key	The secret key that is used for accessing the S3 bucket.

Adding WebRTC Streams

This enables you to add a WebRTC stream, where the source is a webcam and microphone from a web browser. Contact Zixi support for more information on configuration.

➔ To Add a WebRTC Stream:

1. In the Zixi Broadcaster Navigation menu, click the **Inputs** tab.
2. In the Menu bar, click **New Input**. The **Add a new input stream** window is displayed.
3. Enter the unique **Stream ID**.

Broadcaster Inputs

Adding Input Streams



Note: this must be identical (case sensitive) to the stream name configured in the ZEC.

4. Select the maximum concurrent connections to this stream from the **Max. Outputs** drop-down list. Default: Unlimited.
5. Select the **Show in Matrix** check box to display this stream in the Matrix (see [Using the Matrix](#)). Default: Selected.
6. Select **WebRTC** for the input stream.

7. Specify the **Stream Parameters** (see Input Stream Parameter table).
8. If you want to **Enable time shift**, select this checkbox (see Input Stream Parameter table). The stream will be recorded and broadcasted after the specified delay. The time shift feature is typically used to broadcast a live event across time zones (due to the time differences between locations).
9. If you want to **Enable multicast on pull outputs**, select this checkbox (see Input Stream Parameter table).
10. You can encrypt the stream as it enters Zixi Broadcaster. To encrypt the stream, select the **Enable Encryption** checkbox and fill in the parameters as describes in the Input Stream Parameter Table below. For more information, see [Encrypting an Input Stream in Zixi Broadcaster](#).
11. If you want to configure the **Recording Parameters**, specify them in the respective fields (see Input Stream Parameter table).
12. Click **OK**. The “Input added” message appears on the top of the screen. The WebRTC stream is added to the Zixi Broadcaster and now appears in the list of streams available in Zixi Broadcaster inputs UI.

Input Stream Parameters table

Parameter	Description
Stream Parameters	

Broadcaster Inputs

Adding Input Streams

Video Profile	Select an existing transcoding video profile, or select Remove stream if you want to remove the video track.
Audio Profile	Select an existing transcoding audio profile, or select Remove stream if you want to remove the audio track.
Transport Stream Bitrate [kbps]	Specify the bitrate of the transport stream. This parameter is optional. If you do not specify a TS Bitrate, the stream will be VBR. If you specify a bitrate, the stream will be CBR. The bitrate value must be compatible with the selected profile.
Add RTP Headers	<p>Select this checkbox to add RTP headers to the stream. RTP adds a 12-byte header, which includes a sequence number and a timestamp that can be used to detect dropped packets. The sequence number in the RTP headers can be used to do automatic reordering and the timestamps can help overcome inter-packet gaps, also known as IAT (Inter Arrival Time).</p> <p>However, plain RTP does not feature error recovery or error protection. By default, the RTP headers (which include the timestamps and sequences) are being used on the input side, but then they are stripped off and they no longer propagate to outputs.</p>
Smoothing buffer [ms]	The Smoothing feature uses a buffer to time packets according to the stream's clock. This is useful when there are bursts in the rate in which the stream arrives. The smoothing features creates a queue in the buffer, allowing smoother entry into the Broadcaster. The Smoothing parameter defines the size of the buffer in Milliseconds. A larger the buffer enables smoother entry. However, it may influence the latency rate.
Enable time shift	Select this checkbox to record the stream content and broadcast it after a specified delay. To deploy an input stream that uses the current stream's time shift, you need to configure a "Delayed" input stream. (See Adding Delayed Streams).
Maximum delay [hh:mm:ss] (for Time Shift enabled)	Specify the time of a delayed transmission of this stream. Maximum: 24 hours
Enable multicast on pull outputs	Select this checkbox to enable the transmission of this stream's outputs as multicast. A Zixi Broadcaster that will pull the stream will receive it in multicast. By default Zixi Broadcaster is configured to allow transparent fallback to unicast if it is out of the LAN. Requires enabling Multicast Pull in the Settings .
	<div style="border: 1px dashed gray; padding: 5px;"> This setting can be modified without interrupting an existing stream.</div>

Broadcaster Inputs

Adding Input Streams

Multicast-Only (for multicast enabled) If desired, specify multicast-only outputs.

Enable Encryption Select this checkbox to encrypt the Input stream. For more information, see [Encrypting an Input Stream in Zixi Broadcaster](#).

Encryption type (for Encryption enabled) Specify the type of Encryption (AES 128/192/256).

Encryption key (for Encryption enabled) Click **Generate** to generate an encryption key. The generated encryption key must be sent to the end-user to decipher the received encoded stream.

Recording parameters Select this checkbox to customize the recording parameters.

Select the radio button for the desired storage type and then fill in the relevant parameters.

- **Record to disk** – the recording is saved on the local disk. It is possible to record to an external destination by replacing the default storage location with a symbolic link. To learn more, see [Using an External Storage](#) section.
- **Record to S3** – the file is saved to your AWS S3 Bucket. The mechanism uses AWS multipart upload. Amazon advises to define a lifetime rule for objects on destination bucket.

Record to Disk Parameters

Broadcaster Inputs

Adding Input Streams

File Name Template	<p>Specify the file name pattern that Zixi will use to generate when saving the recorded content. A separate file will be generated for each recording up to the time specified in the Max recorded file duration parameter (see above). After this duration a new file will be generated.</p> <p>The file name pattern can include any string and up to five variables listed below. Only the %T=HH.MM.SS creation time is mandatory. You can change the order of these variables and add text as long as you maintain the legitimate structure of the file in Linux and Windows:</p> <ul style="list-style-type: none">• %S=stream id - optional.• %Y=year - optional• %M=month - optional• %D=day - optional• %T=HH.MM.SS creation time – mandatory• %U=YYYYmmddTHHMMSSZ UTC timestamp - optional <p>For example, the following pattern %Y_recording%T.ts will generate the following file name 2017_recording15:32:35.ts.</p>
Max recorded file duration [HH:MM]	Specify the maximum time allotted for recording a video stream. Default: 2 hours
Keep recorded files for [HH:MM]	Specify the maximum time for storing the recording. Default: 0 hours
Custom Path	Optionally specify a storage location for the recorded files that is relative to the root folder. This location bypasses the location specified as the root folder in the Settings > General screen.
Record to S3 Parameters	

Broadcaster Inputs

Adding Input Streams

File Name Template	<p>Specify the file name pattern that Zixi will use to generate when saving the recorded content. A separate file will be generated for each recording up to the time specified in the Max recorded file duration parameter (see above). After this duration a new file will be generated.</p> <p>The file name pattern can include any string and up to five variables listed below. Only the %T=HH.MM.SS creation time is mandatory. You can change the order of these variables and add text as long as you maintain the legitimate structure of the file in Linux and Windows:</p> <ul style="list-style-type: none">• %S=stream id - optional.• %Y=year - optional• %M=month - optional• %D=day - optional• %T=HH.MM.SS creation time – mandatory• %U=YYYYmmddTHHMMSSZ UTC timestamp - optional <p>For example, the following pattern %Y_recording%T.ts will generate the following file name 2017_recording15:32:35.ts.</p>
Max recorded file duration [HH:MM]	Specify the maximum time allotted for recording a video stream. Default: 2 hours
URL	Specify the URL of the S3 bucket.
Ignore TLS certificate errors	TLS certificate for S3 bucket might be detected as faulty if bucket name contains dot[s]. When this option is selected, Zixi Broadcaster will ignore the TLS certificate errors and transmit the stream to its destination.
Access Key	The access key that is used for accessing the S3 bucket.
Secret Key	The secret key that is used for accessing the S3 bucket.

Adding File over HTTP Streams

This enables you to add a File over HTTP stream, where the source is a file on an HTTP server (e.g. S3) that is copied to a temporary location on the local computer.

➔ To Add File over HTTP Stream:

1. In the Zixi Broadcaster Navigation menu, click the **Inputs** tab.
2. In the Menu bar, click **New Input**. The **Add a new input stream** window is displayed.
3. Enter the unique **Stream ID**.



Note: this must be identical (case sensitive) to the stream name configured in the ZEC.

4. Select the maximum concurrent connections to this stream from the **Max. Outputs** drop-down list. Default: Unlimited.
5. Select the **Show in Matrix** check box to display this stream in the Matrix (see [Using the Matrix](#)). Default: Selected.
6. Select **File over HTTP** for the input stream.

7. Specify the **Stream Parameters** (see Input Stream Parameter table).
8. If you want to specify **Billing Codes** to identify and differentiate traffic on a Zixi Broadcaster for billing purposes, select this checkbox (see Input Stream Parameter Table below).
9. If you want to **Enable time shift**, select this checkbox (see Input Stream Parameter table). The stream will be recorded and broadcasted after the specified delay. The time shift feature is typically used to broadcast a live event across time zones (due to the time differences between locations).
10. If you want to **Enable multicast on pull outputs**, select this checkbox (see Input Stream Parameter table).
11. You can encrypt the stream as it enters Zixi Broadcaster. To encrypt the stream, select the **Enable Encryption** checkbox and fill in the parameters as describes in the Input

Broadcaster Inputs

Adding Input Streams

Stream Parameter Table below. For more information, see **Encrypting an Input Stream in Zixi Broadcaster**.

12. If you want to configure the **Recording Parameters**, specify them in the respective fields (see Input Stream Parameter table).
13. Click **OK**. The “Input added” message appears on the top of the screen. The File over HTTP stream is added to the Zixi Broadcaster and now appears in the list of streams available in Zixi Broadcaster inputs UI.

Input Stream Parameters Table

Parameter	Description
Stream Parameters	The general stream settings.
URL	Specify the URL for the File over HTTP stream.
Billing Codes	Billing codes are used to identify and differentiate traffic on a Zixi Broadcaster for billing purposes. When a billing code is added to a Source or Target, Zixi can track the traffic on that Broadcaster input or output separately from other inputs and outputs on the same Broadcaster. Billing codes are created by Zixi personnel on the Zixi Customer Portal for a particular organization.
Billing Code	Enter the billing code that corresponds to this stream. The relevant billing can be obtained from the organization that received the billing code from Zixi.
Billing password	Enter the password that corresponds to this billing code.
Enable time shift	Select this checkbox to record the stream content and broadcast it after a specified delay. To deploy an input stream that uses the current stream's time shift, you need to configure a "Delayed" input stream. (See Adding Delayed Streams).
Maximum delay [hh:mm:ss] (for Time Shift enabled)	Specify the maximum time delay of this input.
Enable multicast on pull outputs	Select this checkbox to enable the transmission of this stream's outputs as multicast. A Zixi receiver that will pull the stream will receive it in multicast. By default Zixi Broadcaster is configured to allow transparent fallback to unicast if it is out of the LAN. Requires enabling Multicast Pull in the Settings.
Multicast Only (for Multicast enabled)	Select the check box to force only Multicast outputs.
Enable Encryption	Select this checkbox to encrypt the Input stream. For more information, see

Broadcaster Inputs

Adding Input Streams

	Encrypting an Input Stream in Zixi Broadcaster.
Encryption type (for Encryption enabled)	Specify the type of Encryption (AES 128/192/256).
Encryption key (for Encryption enabled)	Click Generate to generate an encryption key. The generated encryption key must be sent to the end-user to decipher the received encoded stream.
Recording parameters	Select this checkbox to customize the recording parameters.
Destination Type	<p>Select the radio button for the desired storage type and then fill in the relevant parameters.</p> <ul style="list-style-type: none">• Record to disk – the recording is saved on the local disk. It is possible to record to an external destination by replacing the default storage location with a symbolic link. To learn more, see Using an External Storage section.• Record to S3 – the file is saved to your AWS S3 Bucket. The mechanism uses AWS multipart upload. Amazon advises to define a lifetime rule for objects on destination bucket.
Record to Disk Parameters	<p>Specify the file name pattern that Zixi will use to generate when saving the recorded content. A separate file will be generated for each recording up to the time specified in the Max recorded file duration parameter (see above). After this duration a new file will be generated.</p> <p>The file name pattern can include any string and up to five variables listed below. Only the %T=HH.MM.SS creation time is mandatory. You can change the order of these variables and add text as long as you maintain the legitimate structure of the file in Linux and Windows:</p> <ul style="list-style-type: none">• %S=stream id - optional.• %Y=year - optional• %M=month - optional• %D=day - optional• %T=HH.MM.SS creation time – mandatory• %U=YYYYmmddTHHMMSSZ UTC timestamp - optional <p>For example, the following pattern %Y_recording%T.ts will generate the following file name 2017_recording15:32:35.ts.</p>
File Name Template	
Max recorded file duration	Specify the maximum time allotted for recording a video stream. Default: 2 hours

Broadcaster Inputs

Adding Input Streams

[HH:MM]

Keep recorded files for [HH:MM] Specify the maximum time for storing the recording. Default: 0 hours

Custom Path Optionally specify a storage location for the recorded files that is relative to the root folder. This location bypasses the location specified as the root folder in the **Settings > General** screen.

Record to S3 Parameters

Specify the file name pattern that Zixi will use to generate when saving the recorded content. A separate file will be generated for each recording up to the time specified in the Max recorded file duration parameter (see above). After this duration a new file will be generated.

The file name pattern can include any string and up to five variables listed below. Only the %T=HH.MM.SS creation time is mandatory. You can change the order of these variables and add text as long as you maintain the legitimate structure of the file in Linux and Windows:

- File Name Template**
- %S=stream id - optional.
 - %Y=year - optional
 - %M=month - optional
 - %D=day - optional
 - %T=HH.MM.SS creation time – mandatory
 - %U=YYYYmmddTHHMMSSZ UTC timestamp - optional

For example, the following pattern %Y_recording%T.ts will generate the following file name 2017_recording15:32:35.ts.

Max recorded file duration [HH:MM] Specify the maximum time allotted for recording a video stream. Default: 2 hours

URL Specify the URL of the S3 bucket.

Ignore TLS certificate errors TLS certificate for S3 bucket might be detected as faulty if bucket name contains dot[s]. When this option is selected, Zixi Broadcaster will ignore the TLS certificate errors and transmit the stream to its destination.

Access Key The access key that is used for accessing the S3 bucket.

Secret Key The secret key that is used for accessing the S3 bucket.

Adding Multiplex Streams

This enables you to combine multiple SPTS streams into a single Multiplex stream. The MPTS should have a Target bitrate that is higher than the sum of all of the effective bitrates of the individual STPS inputs included in the multiplex stream. The process involves selecting multiple streams from the list of existing streams. Each input stream will become a Program in the MPTS stream. You will need to name the program and can optionally specify a Program number (by default the first program number is 0). This program number will be assigned to the program in the newly created MPTS, regardless of the original program number. To avoid PID ID conflicts between the PIDs in the source SPTS and the output MPTS, it is recommended to set a Base PID ID number that is high enough. The base PID will be the first number that is used to assign to the various PIDs in the stream. When adding additional streams, make sure that the Base PID number value of the additional stream is higher than 10 than the previous one (e.g. 1000, 1011, etc.).

➔ To Add a Multiplex Stream:

1. In the Zixi Broadcaster Navigation menu, click the **Inputs** tab.
2. In the Menu bar, click **New Input**. The **Add a new input stream** window is displayed.
3. Enter the unique **Stream ID**.



Note: this must be identical (case sensitive) to the stream name configured in the ZEC.

4. Select the maximum concurrent connections to this stream from the **Max. Outputs** drop-down list. Default: Unlimited.
5. Select the **Show in Matrix** check box to display this stream in the Matrix (see [Using the Matrix](#)). Default: Selected.
6. Select **Multiplex** for the input stream.

Stream	Program Name	Program Number	Base PID
--------	--------------	----------------	----------

7. In the **Target bitrate (kbps)** field, specify the target bitrate for the multiplex stream in kbps. The target bitrate number should be at least as high as the sum of all of the effective bitrates of the individual STPS inputs included in the multiplex stream.

Broadcaster Inputs

Adding Input Streams

8. Under **Inputs**, click the **+** button and specify the following settings:
 - Click the **Stream** field to select the STPS stream.
 - The selected stream will become a program in the MPTS stream. In the **Program Name**, enter a name for this program. This overwrites any pre-existing Program Name previously assigned to the stream.
 - In the **Program Number** field, enter a Program Number for the SPTS stream. This overwrites any pre-existing Program Number previously assigned to the stream.
 - In the **Base PID**, enter a Base PID number for the STPS stream. Zixi will automatically assign new PID numbers for all PIDs in the SPTS stream with consecutive numbers following the Base PID number based on this number.
9. Click the **+** again to add another STPS stream and enter the relevant details. Each Input's **Base PID** should be separated by an interval greater than 10 (e.g. 1000, 1011, etc.).
10. Specify additional **Stream Parameters** (see Input Stream Parameter table).
11. If you want to specify **Billing Codes** to identify and differentiate traffic on a Zixi Broadcaster for billing purposes, select this checkbox (see Input Stream Parameter Table below).
12. If you want to **Enable time shift**, select this checkbox (see Input Stream Parameter table). The stream will be recorded and broadcasted after the specified delay. The time shift feature is typically used to broadcast a live event across time zones (due to the time differences between locations).
13. If you want to **Enable multicast on pull outputs**, select this checkbox (see Input Stream Parameter table).
14. If you want to configure the **Recording Parameters**, specify them in the respective fields (see Input Stream Parameter table).
15. You can encrypt the stream as it enters Zixi Broadcaster. To encrypt the stream, select the **Enable Encryption** checkbox and fill in the parameters as describes in the Input Stream Parameter Table below. For more information, see **Encrypting an Input Stream in Zixi Broadcaster**.
16. Click **OK**. The "Input added" message appears on the top of the screen. The Multiplex Stream is added to the Zixi Broadcaster and now appears in the list of streams available in Zixi Broadcaster inputs UI. The created mpts file is accessible in the **File** tab at the top of the Zixi Broadcaster administrative screen and can be added as a new File input stream in the **Add a new input stream** window.

Input Stream Parameters Table

Parameter	Description
Stream Parameters	The general stream settings.
Target bitrate [kbps]	Specify the target bitrate for the multiplex stream. The target bitrate number should be at least as high as the sum of all of the effective bitrates of the individual STPS

Broadcaster Inputs

Adding Input Streams

	inputs included in the multiplex stream.
Inputs	Click <input type="button" value="+"/> to add a stream.
Stream	Select a stream ID from the drop-down list.
Program Name	Enter a Program Name for the SPTS stream. This overwrites any pre-existing Program Name previously assigned to the stream.
Program Number	Enter a Program Number for the SPTS stream. This overwrites any pre-existing Program Number previously assigned to the stream.
Base PID	Enter a Base PID number for the STPS stream. Zixi will automatically assign new PID numbers for all PIDs in the SPTS stream with consecutive numbers following the Base PID number based on this number. Each Input's Base PID should be separated by an interval greater than 10. After the new PID numbers are assigned, they should be saved for future use with the Zixi API.
Billing Codes	Billing codes are used to identify and differentiate traffic on a Zixi Broadcaster for billing purposes. When a billing code is added to a Source or Target, Zixi can track the traffic on that Broadcaster input or output separately from other inputs and outputs on the same Broadcaster. Billing codes are created by Zixi personnel on the Zixi Customer Portal for a particular organization.
Billing Code	Enter the billing code that corresponds to this stream. The relevant billing can be obtained from the organization that received the billing code from Zixi.
Billing password	Enter the password that corresponds to this billing code.
Enable time shift	Select this checkbox to record the stream content and broadcast it after a specified delay. To deploy an input stream that uses the current stream's time shift, you need to configure a "Delayed" input stream. (See Adding Delayed Streams).
Maximum delay [hh:mm:ss] (for Time Shift enabled)	Specify the maximum time delay of this input.
Enable multicast on pull outputs	Select this checkbox to enable the transmission of this stream's outputs as multicast. A Zixi receiver that will pull the stream will receive it in multicast. By default Zixi Broadcaster is configured to allow transparent fallback to unicast if it is out of the LAN. Requires enabling Multicast Pull in the Settings.
Multicast Only (for Multicast enabled)	Select the check box to force only Multicast outputs.
Enable Encryption	Select this checkbox to encrypt the Input stream. For more information, see Encrypting an Input Stream in Zixi Broadcaster .

Broadcaster Inputs

Adding Input Streams

**Encryption type
(for Encryption
enabled)**

Specify the type of Encryption (AES 128/192/256).

**Encryption key
(for Encryption
enabled)**

Click **Generate** to generate an encryption key. The generated encryption key must be sent to the end-user to decipher the received encoded stream.

**Recording
parameters**

Select this checkbox to customize the recording parameters.

Destination Type

Select the radio button for the desired storage type and then fill in the relevant parameters.

- **Record to disk** – the recording is saved on the local disk. It is possible to record to an external destination by replacing the default storage location with a symbolic link. To learn more, see [Using an External Storage](#) section.
 - **Record to S3** – the file is saved to your AWS S3 Bucket. The mechanism uses AWS multipart upload. Amazon advises to define a lifetime rule for objects on destination bucket.
-
-

**Record to Disk
Parameters**

**File Name
Template**

Specify the file name pattern that Zixi will use to generate when saving the recorded content. A separate file will be generated for each recording up to the time specified in the Max recorded file duration parameter (see above). After this duration a new file will be generated.

The file name pattern can include any string and up to five variables listed below. Only the %T=HH.MM.SS creation time is mandatory. You can change the order of these variables and add text as long as you maintain the legitimate structure of the file in Linux and Windows:

- %S=stream id - optional.
- %Y=year - optional
- %M=month - optional
- %D=day - optional
- %T=HH.MM.SS creation time – mandatory
- %U=YYYYmmddTHHMMSSZ UTC timestamp - optional

For example, the following pattern %Y_recording%T.ts will generate the following file name 2017_recording15:32:35.ts.

**Max recorded file
duration
[HH:MM]**

Specify the maximum time allotted for recording a video stream. Default: 2 hours

Broadcaster Inputs

Adding Input Streams

Keep recorded files for [HH:MM] Specify the maximum time for storing the recording. Default: 0 hours

Custom Path Optionally specify a storage location for the recorded files that is relative to the root folder. This location bypasses the location specified as the root folder in the **Settings** > **General** screen.

Record to S3 Parameters

Specify the file name pattern that Zixi will use to generate when saving the recorded content. A separate file will be generated for each recording up to the time specified in the Max recorded file duration parameter (see above). After this duration a new file will be generated.

The file name pattern can include any string and up to five variables listed below. Only the %T=HH.MM.SS creation time is mandatory. You can change the order of these variables and add text as long as you maintain the legitimate structure of the file in Linux and Windows:

File Name Template

- %S=stream id - optional.
- %Y=year - optional
- %M=month - optional
- %D=day - optional
- %T=HH.MM.SS creation time – mandatory
- %U=YYYYmmddTHHMMSSZ UTC timestamp - optional

For example, the following pattern %Y_recording%T.ts will generate the following file name 2017_recording15:32:35.ts.

Max recorded file duration [HH:MM] Specify the maximum time allotted for recording a video stream. Default: 2 hours

URL Specify the URL of the S3 bucket.

Ignore TLS certificate errors TLS certificate for S3 bucket might be detected as faulty if bucket name contains dot[s]. When this option is selected, Zixi Broadcaster will ignore the TLS certificate errors and transmit the stream to its destination.

Access Key The access key that is used for accessing the S3 bucket.

Secret Key The secret key that is used for accessing the S3 bucket.

Viewing Existing Input Streams

The **Inputs** screen displays all the input streams that have been created. At the bottom of the screen you can also view accumulative utilization statistics for any connected streams selected. Hovering the cursor on the status indicator of a stream will provide you with the stream configuration information and basic utilization statistics, where applicable.

Inputs Search Inputs + New Input

Status	ID	Type	Source	Bitrate[kbps]	Up Time	TR 101 290	Error	Outputs	Actions
Connected	bbb	File	17mbps-bbb_sunflower_1080p_60fps_normal-2019-aac.ts	2019	26:14:49	Off	None	2	<input type="button" value="⌵"/> <input type="button" value="⌵"/>
Connected	chub	File	Chubchub-1mbps.ts	1002	26:14:49	Off	None	6	<input type="button" value="⌵"/> <input type="button" value="⌵"/>
Connected	clocks	File	clock.ts	760	26:14:49	Off	None	0	<input type="button" value="⌵"/> <input type="button" value="⌵"/>
Connected	failover	Failover		762	26:14:49	Off	None	0	<input type="button" value="⌵"/> <input type="button" value="⌵"/>

Failover components

Status	Stream	Offset [ms]	Packets
Connected	chub	Out of sync	0
Connected	clocks	0	6828150

Connected	local_rtmp_pull	rtmp_pull	127.0.0.1	964	26:14:33	Off	None	0	<input type="button" value="⌵"/> <input type="button" value="⌵"/>
Connected	local_rtmp_push	* rtmp_push	127.0.0.1	942	26:14:33	Off	None	0	<input type="button" value="⌵"/> <input type="button" value="⌵"/>
Connected	local_srt_pull	SRT-CLIENT	127.0.0.1:5120	1034	26:14:43	Off	None	0	<input type="button" value="⌵"/> <input type="button" value="⌵"/>
Connected	local_srt_push	SRT	127.0.0.1:5100	1034	26:14:28	Off	None	0	<input type="button" value="⌵"/> <input type="button" value="⌵"/>
Connected	moose	File	moose.ts	16638	26:14:49		None	1	<input type="button" value="⌵"/> <input type="button" value="⌵"/>
Connected	mpts_test	File	mpts_20200712-12.43.48.ts	50027	26:14:49	Off	None	0	<input type="button" value="⌵"/> <input type="button" value="⌵"/>
Offline	streamA	Push		0	00:00:00	Off	None	0	<input type="button" value="⌵"/> <input type="button" value="⌵"/>
Connected	webvtt	File	webvtt.ts	10499	26:14:49		None	1	<input type="button" value="⌵"/> <input type="button" value="⌵"/>

Statistics

Bitrate [kbps]: 990	Total Packets: 8564138
Up Time: 26:14:39	Packet Rate: 94
Reconnections: 0	Remuxing Resets: 0
	Remuxing Overflows: 0
	Smoothing Drops: 0

Any of the columns in the following table can be sorted in ascending/descending order by clicking on its heading. The Search text box in the upper left-hand side of the screen can be used to search for a specific input stream by entering the desired Stream ID.

Field	Description
Status	<p>Displays the status of input stream. The following colored indicators are displayed:</p> <ul style="list-style-type: none"> Green = Connected Yellow = Connecting Red = Disconnected with an error condition

Broadcaster Inputs

Viewing Stream Statistics

	<ul style="list-style-type: none">• Blue = Offline with no connection attempts• Grey = Offline and stopped
ID	Displays the unique ID of the stream, as defined in the Zixi Broadcaster.
Type	Displays the type of input stream.
Source	Displays the source host and port number.
Bitrate [kbps]	Displays bitrate of the connected input stream.
Uptime	Displays the amount of time the stream has been active.
TR 101 209	Displays if the Analyzer is active and the streams that are being analyzed according to the TR101 protocol. P1 and P2 are error priorities.
Error	Displays connection and transmission errors.
Outputs	Displays the amount of outputs currently configured for this input stream.
Actions	Provides access to various actions to be performed on this input stream (see Broadcaster Actions on Input Streams).

Viewing Stream Statistics

You can view all the accumulative statistics for a connected input stream in real-time. It is possible to reset the counters by clicking **Reset**. The statistics may differ between the various stream types.

➔ To View Stream Statistics:

1. On the Inputs page of Zixi Broadcaster, click the desired input stream for which you want to view statistics for. The stream's statistics are displayed on the bottom of the screen.

Field	Description
Bitrate (kbps)	Displays the current bitrate of the input stream.
Last Connected	Displays the date and time in which the stream was connected.
Up Time	Displays the amount of time the stream has been active.
Reconnections	Displays the number of reconnection attempts.

Broadcaster Inputs

Viewing Stream Statistics

RTT (ms)	Displays the Round Trip Time (RTT) from the source (in milliseconds).
Jitter (ms)	Displays the current Jitter, measured in milliseconds.
Congestion	Displays an estimation of the communication's congestion level – '0' means congestion free, '100' means fully congested.
Latency (ms)	Displays the stream latency configured on the source Feeder.
Total Packets	Displays the total number of packets that have been transmitted.
Packet Rate	Displays the current number of packets per second.
Merged Packets	Displays number of missing packets recovered using content-based matching (not 2022-7 mode)
Late Packets	Displays the packets thrown away on failover group output, because they were stuck for significantly longer than the search window time (typically performance issues)
Packet Loss %	Displays current percentage of the packets that were dropped on route from the source.
Consecutive Drops	The number of packets that were dropped in a row. When consecutive packets are dropped that could imply burst loss, as opposed to a sustained % of loss that would imply congestion.
Dropped Packets	Displays the total number of packets dropped between the Feeder and the Broadcaster since the beginning of the stream.
Queue Overflows	Displays the number of packets thrown away on failover group entry, because there is no space in the buffer (typically max bitrate too low)
Stream Switches	Displays the number of times a failover group has switched between different streams (not relevant when streams are identical)
SMPTE-2022-7 Mode	Indicates that the streams in a failover group are being merged based on RTP sequences
RTP Drops	Displays the number of missing packets according to RTP sequences
RTP Restarts	Displays the number of time that the RTP stream had a discontinuity, due to a large jump in sequence numbers or in timestamps
Remuxing Resets	Remuxing resets can occur when remuxing to CBR (i.e value of 'Remux to bitrate' field is set). In this case, the value is not high enough to remux the video+audio+other PIDs data. A possible solution is to increase value of the 'Remux to bitrate' parameter.
Remuxing Overflows	This indicates that the multiplexer internal queues are full.

Broadcaster Inputs

Viewing Stream Statistics

Smoothing Drops	The Smoothing feature uses a buffer to time packets according to the stream's clock. This is useful when there are bursts in the rate in which the stream arrives. The smoothing drops indicator indicates that the stream is too "bursty".
Recovered Packets	Displays the number of dropped packets that have been recovered since the beginning of the stream.
Not Recovered Packets	Displays the number of non-recovered packets.
FEC Packets	Displays the number of FEC packets transmitted.
FEC Recovered	Displays the number of FEC packets recovered.
ARQ Requests	Displays the number of requests for retransmission of dropped packets made with ARQ.
ARQ Recovered	Displays the number of dropped packets recovered via ARQ.
ARQ Out of Credit	Displays the number of retransmission requests skipped because it hits a limit, which protects from floods of retransmissions when many packets are missing.
ARQ Duplicates	Displays the number of duplicate recovery packets received via ARQ.
Overflows	The number of packets lost due to buffer overflow. Note: Overflow is usually the result of the Max Bitrate being too low.
Consecutive Not Recovered	Displays the maximal number of consecutive "not recovered packets" in the last measurement period (1 second). This measurement this can help identify long streaks of unrecovered packets, which it is not possible to see by just looking at the global "not recovered" counter.

Searching for Input Streams

➔ To Search for an Input Stream:

1. In the **Inputs** page of Zixi Broadcaster, type in the specific input stream name in the search text box on the left-hand top of the screen and click . The **Input** screen displays the requested input stream(s).

Broadcaster Actions on Input Streams

Every stream has a shortcut button that can be used to perform relevant actions on the stream. The following actions can be performed through the Actions button:

- Adding Analysis to the Input Stream
- Recording the Input Stream
- Stopping/Starting the Input Stream
- Deleting Input Streams from Broadcaster
- Editing Input Settings or Duplicating Input Streams
- Transcoding an Input Stream
- Playing Input Streams with Players
- Add Output
- Traceroute

Stopping/Starting the Input Stream

You can start or stop the input stream at any time.

➔ To Stop/Start the Input Stream:

1. On the **Inputs** page of Zixi Broadcaster, click the desired row of the input stream that you want to stop.
2. Click the  button on the right end of the selected row and then **Stop**. The selected row which was a Connected Input Stream is no longer displayed and appears below as **Offline**.
To continue the Input Stream click **Start** from the same menu.

Editing Input Settings or Duplicating Input Streams

➔ To Edit the Configuration of an Input Stream:

1. In the Zixi Broadcaster **Inputs** page, click the desired input stream that you want to edit.
2. Click  button on the right end of the selected row and then **Edit**. The Edit input stream name window is displayed. You can modify any of the settings.

Click **OK**. The new settings will take effect.

Broadcaster Inputs

Broadcaster Actions on Input Streams

➔ To Duplicate the Configuration of an Input Stream:

1. In the Zixi Broadcaster **Inputs** page, click the desired input stream that you want to duplicate.
2. Click  button on the right end of the selected row and then **Duplicate**. The **Duplicate input stream name** window with the settings of the original input stream is displayed. You can modify any of these settings.
3. Click **OK**. The duplicate input stream with its new settings will be created.

Deleting Input Streams from Broadcaster

➔ To Delete an Input Stream from Broadcaster:

1. In the Zixi Broadcaster **Inputs** page, click the desired input stream that you want to delete.
2. Click the  button on the right end of the selected row and then **Delete**. The message "Are you sure you want to delete input?" is displayed.

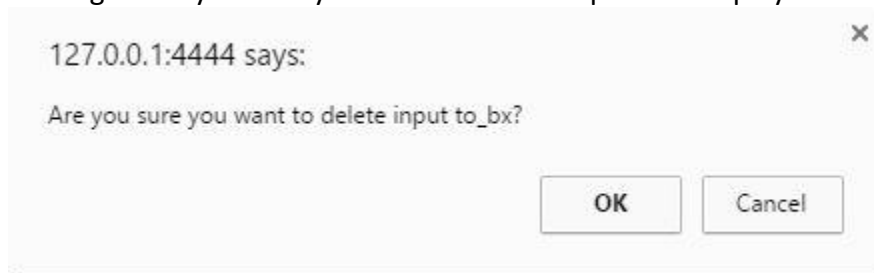

3. Click **OK**. The selected row which was a Connected Input Stream will be deleted.

Recording the Input Stream

You can record an input stream and store it as .TS file. The duration of the time the recording will be kept on the server is defined in the Input Stream configuration. It is possible to record to an external destination by replacing the default storage location with a symbolic link. To learn more, see [Using an External Storage](#) section.

➔ To Record the Input Stream:

1. In the Zixi Broadcaster **Inputs** page, click the desired input stream that you want to record.
2. Click the  button on the selected row and then choose **Record**. A small red dot appears in the green circle at the left-hand side of the selected row indicating that the input stream is being recorded.
3. Clicking **Stop Recording** will stop the recording of the Input Stream and the newly recorded file will appear in the designated file directory in the **Files** page.



Broadcaster Inputs

Broadcaster Actions on Input Streams

Adding TR101 Analysis to the Input Stream

A TR101 analysis can be added to the input stream for the monitoring of the TS while in operation. The analysis can be used to check the integrity of the TS and the most important elements of the stream. The analysis includes priority 1 and 2. To learn more about TR101 analysis see [TR 101 290 Technical Report](#). For more information on Zixi's TR101 analysis, see [Viewing TR101 Analysis](#).

➔ To Add Analysis to the Input Stream:

1. In the Zixi Broadcaster **Inputs** page, click the stream for which you want to analyze from the input streams UI.
2. Click the  button on the right end of the selected row and then select **Analyze**. The statuses of a **P1** (high priority error) and **P2** (low priority error) are indicated by an adjacent green or red button displayed in the *TR 101 290* column. You can view the detailed analysis of the P1 and P1 errors by clicking on the stethoscope icon  shown in the TR 101 290 column. The **Stream Analysis** screen is displayed.

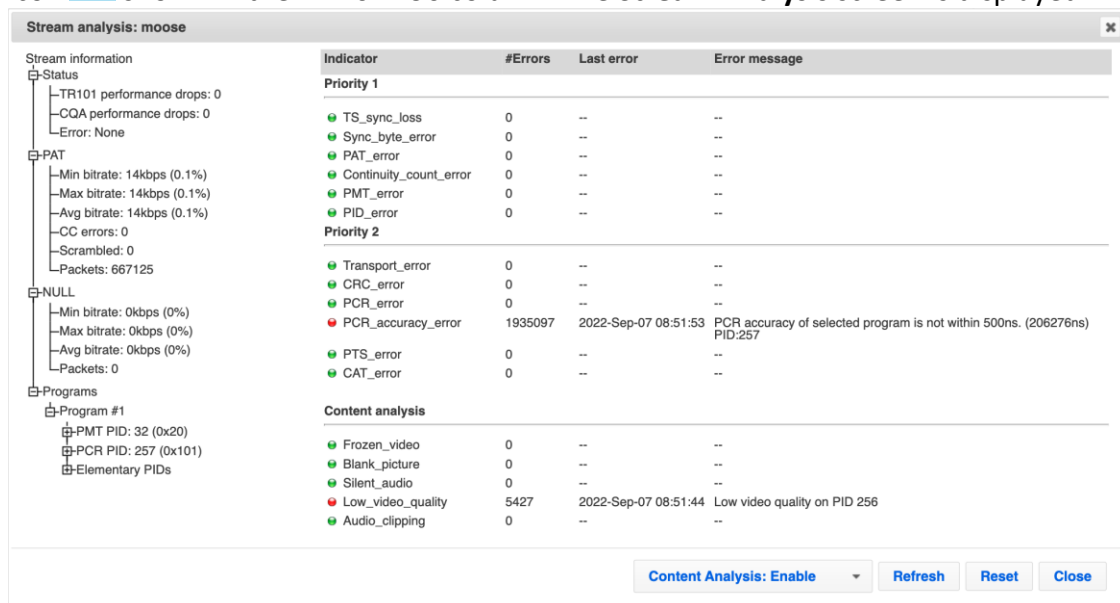

The screenshot shows the 'Stream analysis: moose' window. On the left is a tree view of stream information including Status, PAT, NULL, and Programs. The main area is a table of error indicators.

Indicator	#Errors	Last error	Error message
Priority 1			
TS_sync_loss	0	--	--
Sync_byte_error	0	--	--
PAT_error	0	--	--
Continuity_count_error	0	--	--
PMT_error	0	--	--
PID_error	0	--	--
Priority 2			
Transport_error	0	--	--
CRC_error	0	--	--
PCR_error	0	--	--
PCR_accuracy_error	1935097	2022-Sep-07 08:51:53	PCR accuracy of selected program is not within 500ns. (206276ns) PID:257
PTS_error	0	--	--
CAT_error	0	--	--
Content analysis			
Frozen_video	0	--	--
Blank_picture	0	--	--
Silent_audio	0	--	--
Low_video_quality	5427	2022-Sep-07 08:51:44	Low video quality on PID 256
Audio_clipping	0	--	--

At the bottom right, there are controls: 'Content Analysis: Enable' (dropdown), 'Refresh', 'Reset', and 'Close' buttons.

3. The following can be done from the **Stream Analysis** screen:
 - **Content Analysis** – shows errors in the audio and video content (i.e. Frozen video, Blank picture, Silent audio, Low video quality and Audio clipping).
 - **Refresh** – refreshes the data that is displayed.
 - **Reset** – resets all the field's values to zero.
 - **Close** – closes the **Stream Analysis** screen.

On the left-hand side of the screen is a stream information tree that displays accumulative statistics regarding the stream. Click the + icons to expand the tree.

4. Clicking **Stop Analysis** will discontinue the action.

Transcoding an Input Stream

Zixi Broadcaster offers live transcoding, enabling users to create multiple bitrate streams from a single input stream.

Supported Video and Audio formats include:

- Video Decoding – MPEG2, H.264/AVC, H.265/HEVC
- Video Encoding – MPEG2, H.264/AVC, H.265/HEVC
- Audio Decoding – AAC, MPEG-1 Audio Layer I / II / III, MPEG-2 Audio Layer I / II / III, AC-3 (Dolby Digital)



For AC-3, which can contain up to six discrete channels of sound, the transcoder only supports the left and right channels and will ignore the other channels.

- Audio Encoding – AAC, AAC-HE (High Efficiency) and AAC-HEv2; Pass through (no encoding) – any audio codec (MPEG1/2 / AAC / AC-3, E-AC-3 (Dolby Digital Plus).

The transcoder comes with pre-set common video profiles:

1080i60 / 1080i59.94, 1080p30 / 1080p25, 720p60, 720p50 / 720p30, 576i60 / 576p25, 480i60 / 480p29.97

In order to transcode an input stream from the Inputs screen you must first configure the transcoding profiles in the Transcoder screen. For more information, see [Transcoder](#) section.



Transcoding is not currently supported in ARM builds of Zixi Broadcaster.

Broadcaster Inputs

Broadcaster Actions on Input Streams

➔ To Transcode an Input Stream:

1. In the Zixi Broadcaster **Inputs** page, click the desired input stream that you want to transcode.
2. Click  button on the right end of the selected row and then **Transcode**. The **Transcode <input stream name>** window with the settings of the selected input stream is displayed.

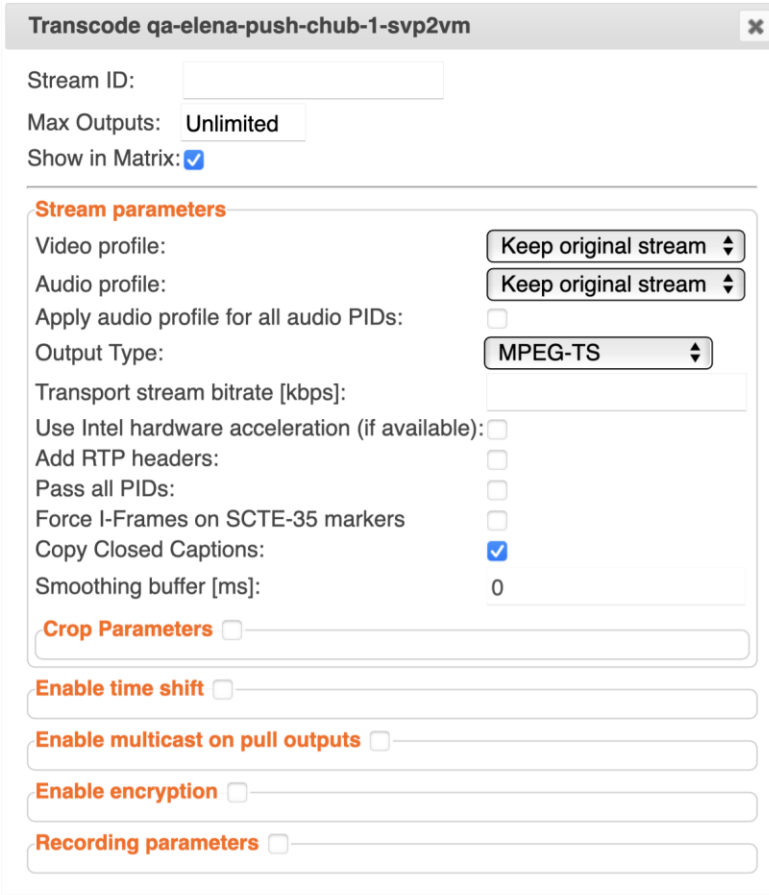

Stream ID:

Max Outputs:

Show in Matrix:

Stream parameters

Video profile:

Audio profile:

Apply audio profile for all audio PIDs:

Output Type:

Transport stream bitrate [kbps]:

Use Intel hardware acceleration (if available):

Add RTP headers:

Pass all PIDs:

Force I-Frames on SCTE-35 markers:

Copy Closed Captions:

Smoothing buffer [ms]:

Crop Parameters

Enable time shift

Enable multicast on pull outputs

Enable encryption

Recording parameters

Enter the unique **Stream**

ID., which will correspond to the new transcoded input that will be added.

3. Under Stream Parameters, in the **Video profile** and **Audio profile** fields, do one of the following:
 - Select the desired Video Profile and/or Audio Profile that you have configured.
 - Select **Keep original stream** - if you have not configured a video or audio profile or do not want it transcoded or you want to set specific transcoding parameters for the specific stream. In this case the video or audio input will not be transcoded.
 - Select **Remove stream** – you can use the transcoder to remove the video or audio track from the stream.
4. Fill in additional fields (see table below for additional parameters).

Broadcaster Inputs

Broadcaster Actions on Input Streams

5. Click **OK**. The transcoded input stream is created and appears in an embedded window labeled Transcoded sources under the original input stream from which it was created.

Parameter	Description
Video Profile	Select an existing profile, select Keep original stream if you do not wish to transcode the video stream, or select Remove stream if you want to remove the video track.
Audio Profile	Select an existing profile, select Keep original stream if you do not wish to transcode the audio stream, or select Remove stream if you want to remove the audio track.
Apply audio profile for all audio PIDs	Select this checkbox to apply the selected audio profile for all PIDs.
Output Type	<p>Select one of the following output types. The outputs are configured as part of the transcoding process, so there is no need to create the Output from the Zixi Broadcaster Outputs screen:</p> <ul style="list-style-type: none">• MPEG-TS – the output will be available as MPEG Transport Stream.• NDI – the output will be available as NDI. When selecting NDI output, you can select the following video/audio profiles:<ul style="list-style-type: none">○ Video profile – remove stream or a Raw profile.○ Audio profile - remove stream or a Raw profile.• WebRTC – the output will be available as WebRTC. When selecting NDI output, you can select the following video/audio profiles:<ul style="list-style-type: none">○ Video profile – remove stream, keep original stream, Raw video profile, or if the input stream is not WebRTC compliant, a transcode to WebRTC compliant profile (e.g. H.264 codec with Baseline or Main profile and no B frames).Audio profile - remove stream, keep original stream, Raw audio profile, or if the input stream is non-Opus, transcode to Opus.
Transport Stream Bitrate (Kbps)	<p>Specify the bitrate of the MPEG transport stream (TS).</p> <p>This parameter is optional. If you do not specify a TS Bitrate, the transport stream will be variable bitrate (VBR) with no additional null packets added. If you specify a bitrate, the transport stream will be constant bitrate (CBR) where null packets are added as necessary to achieve the specified bitrate.</p> <p>CBR transport streams are typically required when sending a stream to a satellite head-end or to a professional integrated receiver-decoder (IRD). The overhead of MPEG TS is about 7%. To determine the bitrate setting, sum the max video bitrate and audio bitrate from the encoding profile and then add the other PIDs (if choosing to pass all PIDs) and add 7%. If the bitrate needed for the transport stream exceeds</p>

Broadcaster Inputs

Broadcaster Actions on Input Streams

the value specified, the Broadcaster will give a “bitrate too low” error message.

VBR transport streams are typically used for HLS, DASH, RTMP, and other similar live streaming workflows.

Use Intel hardware acceleration (if available) Select this checkbox to use Intel hardware acceleration component if it has been installed.

Pass all PIDs Select this checkbox to pass-through all non-transcoded PIDs.

Add RTP Headers Select this checkbox to add RTP headers to the stream. RTP adds a 12-byte header, which includes a sequence number and a timestamp that can be used to detect dropped packets. The sequence number in the RTP headers can be used to do automatic reordering and the timestamps can help overcome inter-packet gaps, also known as IAT (Inter Arrival Time).
However, plain RTP does not feature error recovery or error protection. By default, the RTP headers (which include the timestamps and sequences) are being used on the input side, but then they are stripped off and they no longer propagate to outputs.

Force I-Frames on SCTE-35 markers Select this checkbox to force an I-frame on the frame with the PTS mentioned in the SCTE35 message or on the first frame after that PTS, if it doesn’t exist in the stream.

Copy Closed Captions Select this checkbox to copy CC (if exist on original stream) to the transcoded stream. Applicable to HEVC/H264 sources and profiles only.

Crop Parameters Select this checkbox to set the cropping parameters.

Cropping Mode Set the units used for defining the crop. Options are: *Pixels* or *Percentages*.
Note: Depending on the type of content, in some cases using different crop values for low resolution outputs might be appropriate. For example, if the content includes both video content and textual content, the text would not be readable at lower resolutions and thus might be better to exclude. Another use case for using different crop values for each output would be to slice a 360 or VR input video.

Left, Top Specify the left and top positions for the crop.

Width x Height Specify the width and height values for the crop.

Smoothing Buffer (ms) Specify how much of the transcoded stream (in milliseconds) to store before transmitting it back to the server in order to prevent bursts.
If the **Transport stream bitrate [kbps]** field is empty, the smoothing buffer is disabled.
If the **Transport stream bitrate [kbps]** field is NOT empty, it is recommended to enter around 200ms, which should be enough to prevent bursts.

Enable time shift Select this checkbox to record the stream content and broadcast it after a specified

Broadcaster Inputs

Broadcaster Actions on Input Streams

	delay. To deploy an input stream that uses the current stream's time shift, you need to configure a "Delayed" input stream. (See Adding Delayed Streams).
Maximum delay [hh:mm:ss]	Specify the time of the delayed transmission of this stream. Maximum: 24 hours.
Enable multicast on pull outputs	Selecting this checkbox enables the transmission of this stream's outputs as multicast. A Zixi receiver that will pull the stream will receive it in multicast. By default, Zixi Broadcaster is configured to allow transparent fallback to unicast if it is out of the LAN. Requires enabling Multicast Pull in the Settings. This setting requires enabling Multicast Pool (Settings > Multicast Pool).
Multicast Only	Selecting this checkbox will force the transmission of this stream only in multicast.
Enable Encryption	Select this checkbox to encrypt the Input stream. For more information, see Encrypting an Input Stream in Zixi Broadcaster .
Encryption type (for Encryption enabled)	Specify the type of Encryption (AES 128/192/256).
Encryption key (for encryption enabled)	Click Generate to generate an encryption key. The generated encryption key must be sent to the end-user to decipher the received encoded stream.
Recording parameters	Select this checkbox to customize the recording parameters.
Destination Type	Select the radio button for the desired storage type and then fill in the relevant parameters. <ul style="list-style-type: none">• Record to disk – the recording is saved on the local disk.• Record to S3 – the file is saved to your AWS S3 Bucket.
Record to Disk Parameters	Specify the file name pattern that Zixi will use to generate when saving the recorded content. A separate file will be generated for each recording up to the time specified in the Max recorded file duration parameter (see above). After this duration a new file will be generated. The file name pattern can include any string and up to five variables listed below. Only the %T=HH.MM.SS creation time is mandatory. You can change the order of these variables and add text as long as you maintain the legitimate structure of the file in Linux and Windows: <ul style="list-style-type: none">• %S=stream id - optional.• %Y=year - optional

Broadcaster Inputs

Broadcaster Actions on Input Streams

- %M=month - optional
- %D=day - optional
- %T=HH.MM.SS creation time - mandatory

For example, the following pattern %Y_recording%T.ts will generate the following file name 2017_recording15:32:35.ts.

Max recorded file duration [hours] Specify the maximum time allotted for recording a video stream. Default: 2 hours

Keep recorded files for [hours] Specify the maximum time for storing the recording. Default: 0 hours

Custom Path Optionally specify a storage location for the recorded files that is relative to the root folder. This location bypasses the location specified as the root folder in the **Settings > General** screen.

Record to S3 Parameters

Specify the file name pattern that Zixi will use to generate when saving the recorded content. A separate file will be generated for each recording up to the time specified in the Max recorded file duration parameter (see above). After this duration a new file will be generated.

The file name pattern can include any string and up to five variables listed below. Only the %T=HH.MM.SS creation time is mandatory. You can change the order of these variables and add text as long as you maintain the legitimate structure of the file in Linux and Windows:

File Name Template

- %S=stream id - optional.
- %Y=year - optional
- %M=month - optional
- %D=day - optional
- %T=HH.MM.SS creation time - mandatory

For example, the following pattern %Y_recording%T.ts will generate the following file name 2017_recording15:32:35.ts.

Max recorded file duration [hours] Specify the maximum time allotted for recording a video stream. Default: 2 hours

URL Specify the URL of the S3 bucket.

Ignore TLS certificate errors TLS certificate for S3 bucket might be detected as faulty if bucket name contains dot[s]. When this option is selected, Zixi Broadcaster will ignore the TLS certificate errors and transmit the stream to its destination.

Broadcaster Inputs

Broadcaster Actions on Input Streams

Access Key	The access key that is used for accessing the S3 bucket.
-------------------	--

Secret Key	The secret key that is used for accessing the S3 bucket.
-------------------	--

Add Output

This is an alternative method (shortcut) to adding an output to a specific input stream instead of configuring it through the **Outputs** screen. The available types of outputs are:

- **UDP** – Target is a UDP or RTP stream, over unicast or multicast.
- **RTMP** – Real Time Messaging Protocol streams can be played on systems that accept this protocol as input. Originally designed to enable Adobe® Flash® streams to be sent between a server and a client, RTMP has become a popular protocol for streaming into content-delivery networks (CDNs).
- **Pull** – Pull streams are Zixi protocol streams destined for Zixi Receivers or ZEC. In this case, the Zixi Broadcaster can offer status and statistics for a stream that is being pulled from it by another device.
- **Push** – Push streams are Zixi protocol streams destined for other Zixi Broadcasters.
- **TCP** – The TCP output can push the stream directly to a TCP socket or to an HTTP server.
- **HTTP Push** – The HTTP Push output stream can be encapsulated in HLS or DASH. The source of the output stream is a predefined adaptive group that has been configured in the [Adaptive Groups](#) screen. The configuration of the stream includes the option to delete outdated stream fragments on the server. Output streams can be pushed to one Zixi Broadcasters or Zixi Receiver.
- **AWS** – The HTTP output stream (HLS or DASH) can be pushed to an AWS S3 Bucket or too an Elemental MediStore. The native S3 support includes the ability to configure the S3 authentication credential, including the Region, Access Key, and Secret Key.
- **SRT** – The SRT stream is pulled from the Zixi Broadcaster by an SRT Client. The connection is initiated by the target SRT client.
- **SRT Client** – The SRT stream is pushed to an SRT-compatible target. The connection is initiated by Zixi Broadcaster.
- **RIST** – The RIST output stream can be pushed to an external target using Simple or Main Profile over unicast or multicast. The output stream can include Forward Error Correction (SMPTE-2022 FEC).

Broadcaster Inputs

Broadcaster Actions on Input Streams

➔ To Add Output:

1. In the Zixi Broadcaster Navigation menu, click the **Inputs** tab.
2. Click the Settings button , and then click **New Output**. The **New Output** window with the settings of the selected output stream is displayed.

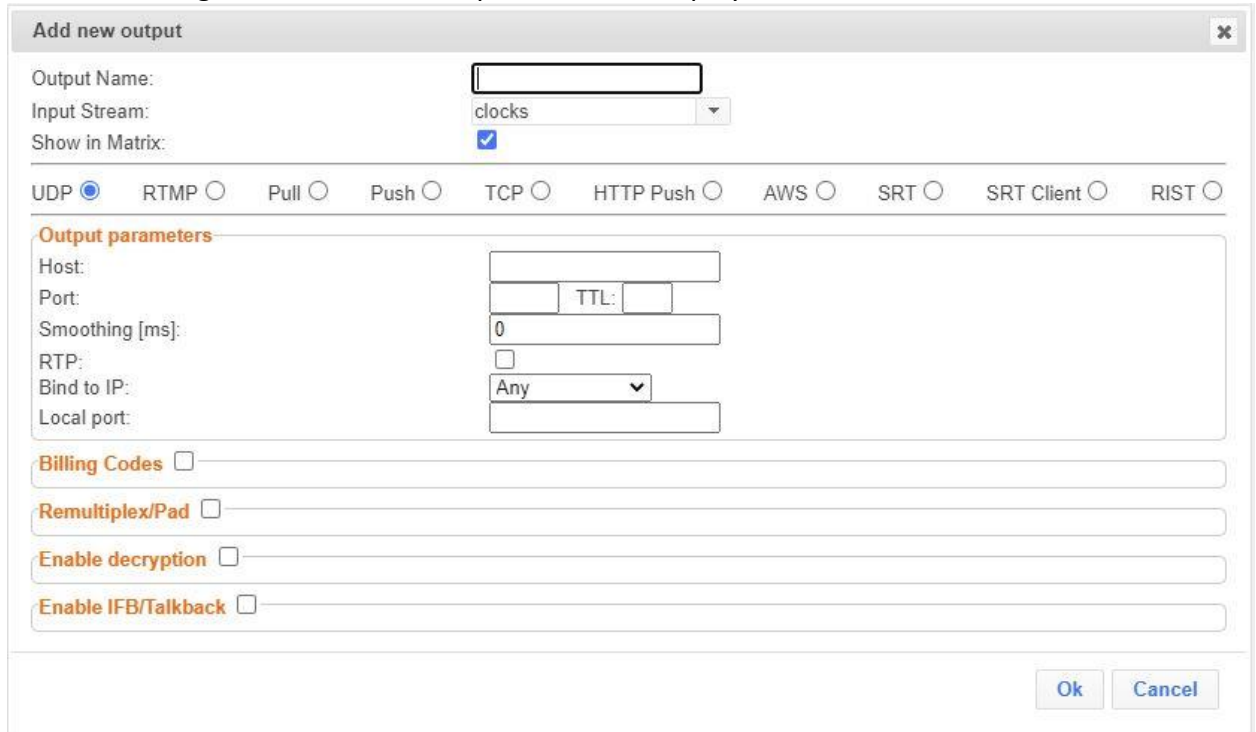

The screenshot shows the 'Add new output' dialog box. It features a title bar with a close button. The main area contains the following elements:

- Output Name:** A text input field.
- Input Stream:** A dropdown menu currently showing 'clocks'.
- Show in Matrix:** A checked checkbox.
- Output Type Selection:** A row of radio buttons for UDP (selected), RTMP, Pull, Push, TCP, HTTP Push, AWS, SRT, SRT Client, and RIST.
- Output parameters:** A section with fields for Host, Port, Smoothing [ms] (set to 0), RTP (unchecked), Bind to IP (set to Any), and Local port.
- Advanced Options:** Four checkboxes for Billing Codes, Remultiplex/Pad, Enable decryption, and Enable IFB/Talkback.
- Buttons:** 'Ok' and 'Cancel' buttons at the bottom right.

3. Follow the specific instructions of each output type from one of the following sections:
 - [Adding UDP Outputs](#)
 - [Adding RTMP and RTMPS Outputs](#)
 - [Adding Pull Outputs](#)
 - [Adding Push Outputs](#)
 - [Adding TCP Outputs](#)
 - [Adding HTTP Push Outputs](#)
 - [Adding AWS Outputs](#)
 - [Adding SRT Outputs](#)
 - [Adding SRT Client Outputs](#)
 - [Adding RIST Outputs](#)

Playing Input Streams with Players

You can preview the input streams through the following video players:

Broadcaster Inputs

Broadcaster Actions on Input Streams

- VLC Player
- Flash Player
- Shoutcast
- WebRTC

In order to preview an input stream, you must first configure its output. See **Broadcaster Outputs** section for more details.

➔ To Play Input Streams with a VLC Player:

1. In the Zixi Broadcaster **Inputs** page, click the desired input stream that you want to play with VLC.
2. Click the  button on the right end of the selected row and then **Play with VLC**. The **Link Description** window with the directory path for the desired file is displayed.
3. Click **Run VLC**. The selected file is downloaded to the computer.
4. Double-click on the newly downloaded file. This configured file runs using the VLC player and appears on a new output line on the **Output** screen wherein it can be monitored. Alternatively, copy the path and send it to the user so it can be entered in the Network URL of the VLC player.

➔ To Play Input Streams with a Flash Player:

Flash Player enables playing the stream on a native browser with the Flash player.

1. In the Zixi Broadcaster **Inputs** page, click the desired input stream that you want to play with Flash Player.
2. Click the  button on the right end of the selected row and then **Play with Flash**. The **Link Description** window with the directory path and proxy path for the desired file is displayed.
3. Click **Run** to view the .flv file that appears on the first line of the window or **Run Accelerated** to run the file from the proxy server with better results.

➔ To Play Input Streams with Shoutcast:

Shoutcast enables playing an audio file on a native browser.

1. In the Zixi Broadcaster **Inputs** page, click the desired input stream that you want to play with Shoutcast.
2. Click the  button on the right end of the selected row and then **Play with Shoutcast**. The **Link Description** window will open with the directory path for the desired file.

➔ To Play Input Streams with WebRTC:

WebRTC enables playing a video file on a native browser without the need for plug-ins or extensions. In order to enable transcoding of non-WebRTC compliant streams you need to first create the relevant Transcoding Profiles. You need to create separate video and audio profiles for use with Single Version and Multiple Version transcoding methods. You will then be able to

Broadcaster Inputs

Broadcaster Actions on Input Streams

apply those profiles to your streams as needed. For more information on how to setup the transcoding profiles, see ***How to Monitor Streams Using WebRTC*** guide.

1. In the Zixi Broadcaster **Inputs** page, click the desired WebRTC input stream that you want to play.
2. Click the  button on the right end of the selected row and then **Play WebRTC**. The **Link Description** window will open with the directory path for the desired file and a link to open a browser window to play the stream.

Link description ✕

WebRTC

<http://18.188.220.36:4444/webrtc.html?stream=8dacd9c9-3232-4350-b325-4193e67d061d-WebRTC-03>

[Open WebRTC player](#)

[Close](#)

Copy the link or click the **Open WebRTC player** link to view the stream.

Broadcaster Inputs

Broadcaster Actions on Multiple Inputs

Viewing Traceroutes

For streams sent from a Zixi Feeder (v13 and above) to a Zixi Broadcaster (v13 and above), you can view traceroute data for the stream.

➔ To view traceroute data:

1. On the **Inputs** page of Zixi Broadcaster, click on the row of the input stream for which you want to view traceroutes.
2. Click the  button on the right end of the selected row and then select **Trace**.
3. The traceroute data for this stream is displayed.

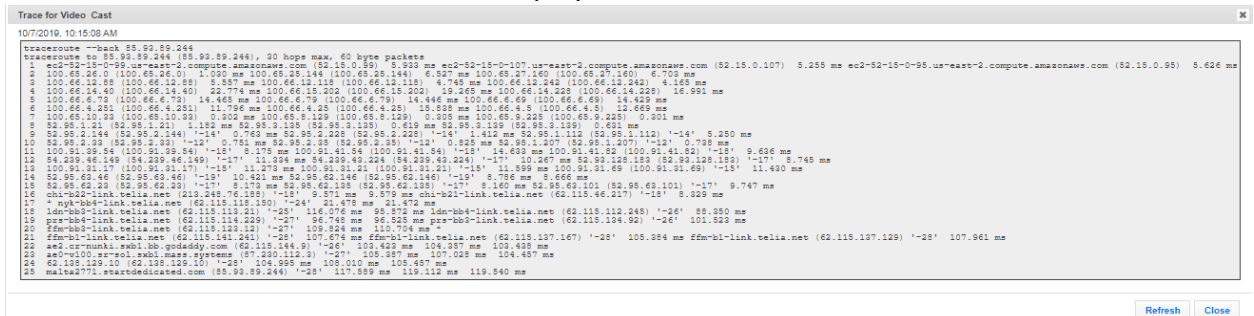

4. You can refresh the Traceroute data at any time by clicking the **Refresh** button.

Broadcaster Actions on Multiple Inputs

In the Inputs screen, you can perform actions on multiple or all input streams at once by selecting them using the check boxes and then clicking the Marked drop-down menu.

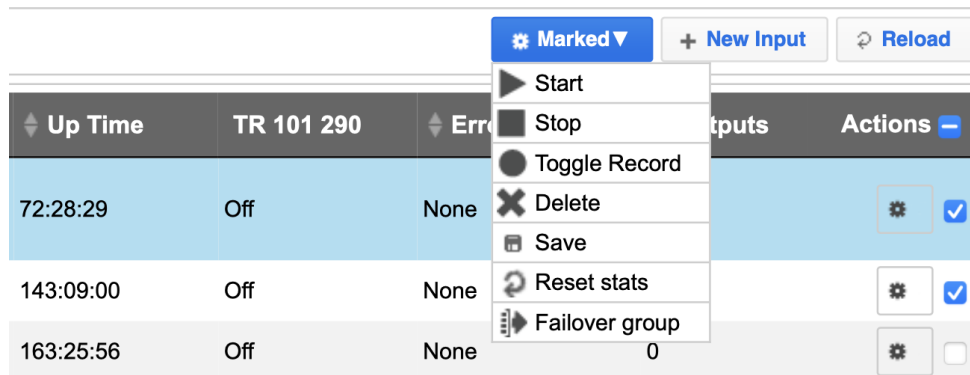

The actions include the following:

Starting and Stopping Multiple Input Streams

You can Start/Stop multiple streams.

➔ To Start/Stop multiple Input Streams:

1. In the Zixi Broadcaster Inputs screen, select the relevant Inputs by selecting the checkboxes.

Broadcaster Inputs

Broadcaster Actions on Multiple Inputs

2. Click the Marked drop-down menu and then click **Stop** or **Start**.
The selected input streams will be started/stopped.

Toggle Input Stream Records

➔ To Toggle Input Stream Records:

1. In the Zixi Broadcaster Inputs screen, select the relevant Inputs by selecting the checkboxes.
2. Click the Marked drop-down menu and then click **Toggle Record**.
The input streams are toggled.

Deleting Multiple Input Streams

➔ To Delete Multiple Input Streams:

1. In the Zixi Broadcaster Inputs screen, select the relevant Inputs by selecting the checkboxes.
2. Click the **Marked** drop-down menu and then click **Delete**.

The following notification appears:

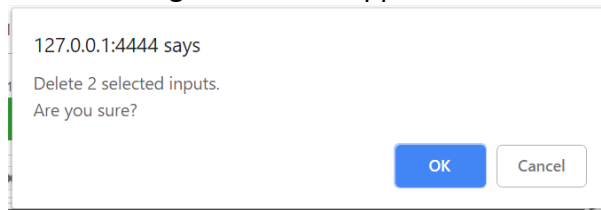

3. Click **OK**.

Saving Multiple Input Streams

➔ To Save Multiple Input Streams:

1. In the Zixi Broadcaster Inputs screen, select the relevant Inputs by selecting the checkboxes.
2. Click the **Marked** drop-down menu and then click **Save**.
All changes to the input streams are saved.

Resetting Stats for Multiple Input Streams

➔ To Reset Stats for Multiple Input Streams:

1. In the Zixi Broadcaster Inputs screen, select the relevant Inputs by selecting the checkboxes.
2. Click the **Marked** drop-down menu and then click **Reset Stats**.
All accumulated stream statistics are reset.

Creating a Failover Group

Zixi Broadcaster supports failover based on TR-101, CQA, and unrecovered packet errors. The trigger for the failover includes TR-101 P1 and P2 errors, Frozen Video, Blank Picture, Audio Clipping, Bitrate below threshold, and unrecovered packets. Through ZEN Master and through the Zixi API it is possible to combine multiple triggers into a Boolean expression to determine when to trigger the failover.

In addition, Zixi features hitless failover for inputs, enabling uninterrupted streaming when switching from one source to another. The hitless failover configuration involves grouping two or more inputs in a "Failover Group". If the inputs are identical (i.e. two or more binary-identical streams with synchronized RTP headers), whenever one of them is disrupted or interrupted completely, Zixi Broadcaster will seamlessly use the packets of the other input without any disruptions by "merging" the streams. The merging of the streams can be achieved using one of the following methods:

- **RTP headers (SMPTE 2022-7)** – if the sources are RTP and the RTP headers were maintained, Zixi will use the SMPTE 2022-7 to compare and merge the two streams in order to allow hitless failover. This option is the most recommended as it will use the sequence and the timestamp in the packets to compare which packets are missing. This method is more accurate than methods that compare the entire payload or methods that use sophisticated DNA sequencing algorithm, which are more error prone, as the payload may have multiple matches.
- **RTP headers or TS content** – if the sources do not have RTP headers, Zixi will try to merge using the MPEG-TS content itself.



If the streams are not identical, the failover process will not be seamless and may take up to a second.

The following procedure describes how to configure inputs as a Failover Group in Zixi Broadcaster.

➔ To create a Failover Group:

1. On the Input screen of Zixi Broadcaster, select the checkboxes of the relevant identical input streams.

Broadcaster Inputs

Broadcaster Actions on Multiple Inputs

- At the top of the inputs list, click the **Marked** drop-down menu and then click **Failover Group**.

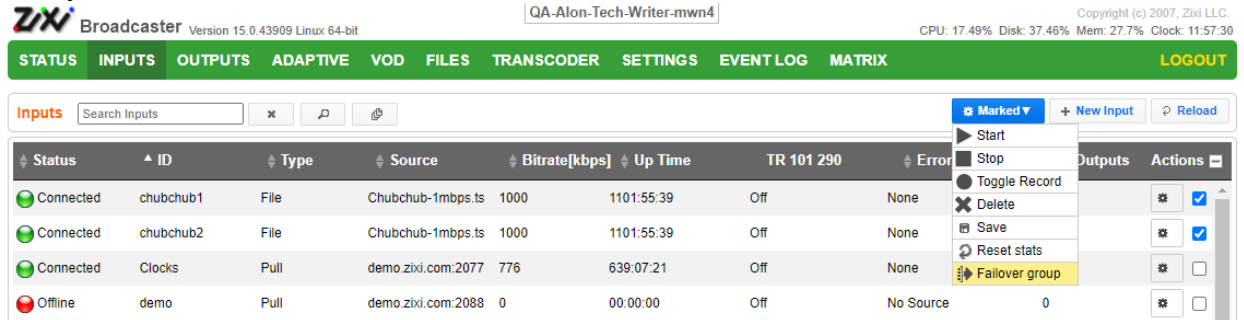

The screenshot shows the Zixi Broadcaster interface. At the top, there's a navigation bar with tabs: STATUS, INPUTS, OUTPUTS, ADAPTIVE, VOD, FILES, TRANSCODER, SETTINGS, EVENT LOG, MATRIX, and LOGOUT. Below the navigation bar is a search bar for inputs and a 'Marked' dropdown menu. The 'Marked' dropdown menu is open, showing options: Start, Stop, Toggle Record, Delete, Save, Reset stats, and Failover group. The 'Failover group' option is highlighted. Below the dropdown is a table of inputs with columns: Status, ID, Type, Source, Bitrate[kbps], Up Time, TR, 101 290, Error, Outputs, and Actions.

Status	ID	Type	Source	Bitrate[kbps]	Up Time	TR	101 290	Error	Outputs	Actions
Connected	chubchub1	File	Chubchub-1mbps.ts	1000	1101:55:39	Off	None	None		Start, Stop, Toggle Record, Delete, Save, Reset stats, Failover group
Connected	chubchub2	File	Chubchub-1mbps.ts	1000	1101:55:39	Off	None	None		Start, Stop, Toggle Record, Delete, Save, Reset stats, Failover group
Connected	Clocks	Pull	demo.zixi.com:2077	776	639:07:21	Off	None	None		Start, Stop, Toggle Record, Delete, Save, Reset stats, Failover group
Offline	demo	Pull	demo.zixi.com:2088	0	00:00:00	Off	No Source	0		Start, Stop, Toggle Record, Delete, Save, Reset stats, Failover group

- The **Create a Failover Group** window opens:

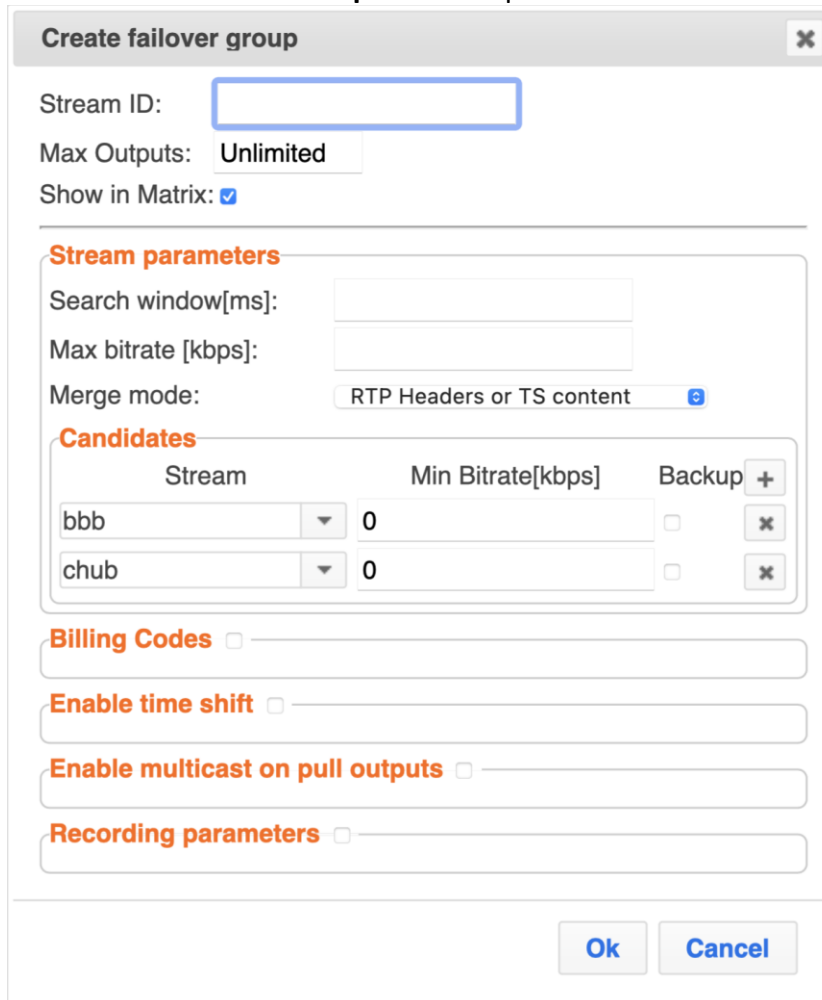

The 'Create failover group' dialog box is shown. It has a title bar with a close button. The fields are: Stream ID (text input), Max Outputs (Unlimited), Show in Matrix (checked). Below these are sections for Stream parameters (Search window[ms], Max bitrate [kbps], Merge mode: RTP Headers or TS content), Candidates (table with Stream, Min Bitrate[kbps], Backup), Billing Codes, Enable time shift, Enable multicast on pull outputs, and Recording parameters. At the bottom are Ok and Cancel buttons.

Stream	Min Bitrate[kbps]	Backup
bbb	0	<input type="checkbox"/>
chub	0	<input type="checkbox"/>

- In the **Stream ID** field, type a new name for Failover Group. This name will appear in the list of Inputs.
- In the **Max Outputs** field, type the number of desired concurrent outputs that can use the **Failover Group**. Default: Unlimited.

Broadcaster Inputs

Encrypting an Input Stream in Zixi Broadcaster

6. In the **Search Window** field, type the timeframe in which the system can search for the relevant packets in a matching stream. If there is a latency difference between the streams in the group, the **Search Window** value should be higher than the latency difference between the streams. In case the **Merge Mode** is set to **No Merge**, the **Search Window** time specifies how long the stream will wait for packets before attempting to switch between streams.
7. In the **Max Bitrate** field, specify the maximum bitrate of the stream. Default: 8000. This is used for internal memory allocation and will not affect the transmitted bitrate. Recommended: double the bitrate of the highest bitrate stream.
8. In the **Merge mode** field, select one of the following:
 - **No merge** – select this option if you want Zixi to treat the streams as different and not try to merge the streams. In this case, the time period specified in the **Search Window** field defines how long the stream will wait for packets before attempting to switch between streams.
 - **RTP headers (SMPTE 2022-7)** – select this option if the sources are RTP and the RTP headers were maintained. In this case, Zixi will use the SMPTE 2022-7 to compare and merge the two streams in order to allow hitless failover. This option is the most recommended as it will use the sequence and the timestamp in the packets to compare which packets are missing. This method is more accurate than methods that compare the entire payload or methods that use sophisticated DNA sequencing algorithm, which are more error prone, as the payload may have multiple matches.
 - **RTP headers or TS content** – select this option if you are not sure if the sources do have RTP headers. In this case, Zixi will try to merge using RTP and if not, using the MPEG-TS content itself.
9. Under **Candidates**, if you want to configure one or more of the streams as back up, select the checkbox next to the relevant stream. Backup streams will be used only when all the "Primary" streams are down.
10. Configure additional parameters as required.
11. Click **OK**.

The Failover Group is added to the list of inputs, listing the sub-streams that are part of the group. The system will automatically detect the offset between the sub-streams and display it in milliseconds under Offset (ms).

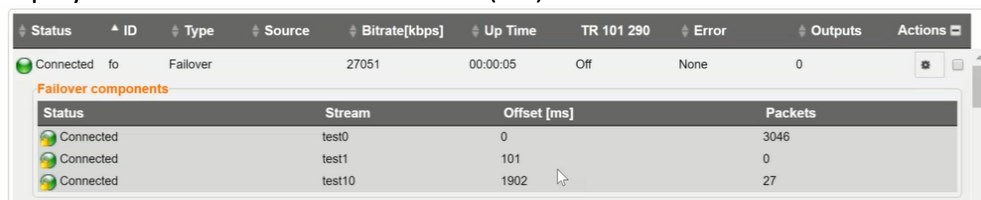

Status	ID	Type	Source	Bitrate[kbps]	Up Time	TR 101 290	Error	Outputs	Actions
Connected	fo	Failover		27051	00:00:05	Off	None	0	
Failover components									
Status	Stream	Offset [ms]	Packets						
Connected	test0	0	3046						
Connected	test1	101	0						
Connected	test10	1902	27						

Encrypting an Input Stream in Zixi Broadcaster

You can encrypt a specific input stream using static key AES scrambling encryption (AES 128, AES 192, AES 256). If the stream has been encrypted at the source, it can be encrypted by Zixi

Broadcaster Inputs

Decrypting an Input Stream in Zixi Broadcaster

Broadcaster only after its decryption (See: [Decrypting an Input Stream in Zixi Broadcaster](#)). The stream encryption prevents any further processing, such as analysis, transcoding, etc. For more information, see [Transcoder](#) section.

➔ To encrypt an input stream in Zixi Broadcaster:

1. In **Inputs** screen, click **+New Input**.
2. Select the relevant input type.
3. Fill in the stream parameters.
4. At the bottom, select the **Enable Encryption** checkbox.
5. In the **Encryption Type** field, select **AES 128**, **AES 192**, **AES 256** for fixed encryption.
6. In the **Encryption Key** field, enter your own key or click **Generate** to generate a key by the system. The exact key should be used to decrypt the stream on the other end.

The screenshot shows the 'Add new input stream' dialog box. The 'Enable encryption' checkbox is checked. The 'Encryption type' is set to 'AES 128'. The 'Encryption key' field contains a generated key: '04c8f613f38b5a0c5fc88ce586f7df92'. The 'Generate' button is visible next to the key field.

7. Click **OK**.

Decrypting an Input Stream in Zixi Broadcaster

Any stream that has been encrypted using standard AES static key can be decrypted in Zixi Broadcaster. You can configure the decryption of a specific stream by entering the decryption key.

➔ To decrypt an input stream in Zixi Broadcaster:

1. In **Inputs** screen, click **+New Input**.
2. Select **Push** or **Pull**.
3. Fill in the input details.
4. At the bottom, select the **Decrypt Stream** checkbox.
5. In the **Decryption Type** field, select **AES 128**, **AES 192**, **AES 256** for fixed key.

Broadcaster Inputs

Demuxing an MPTS Stream

6. In the **Decryption Key** field, enter the exact same key that was used to encrypt the stream.

The screenshot shows a web interface for adding a new input stream. The 'Decryption stream' checkbox is checked, and the 'Decryption key' field contains the key '04c8f813f38b5a0c5fc88ce586f7df92'. The dialog also shows options for Stream ID, Max Outputs, Show in Matrix, and various input protocols like Push, Pull, UDP, etc.

7. Click **OK**.

Demuxing an MPTS Stream

MPTS (Multi Program Transport Streams) streams can be demuxed into single SPTS (Single Program Transport Streams) streams. MPTS demuxing is available for Pull, Push, UDP, and File input streams. From the various programs in the MPTS stream, you can select specific programs, which will be turned into individual SPTS input streams.

➔ To demux an MPTS stream:

1. Create a Pull/Push/UDP/File input stream using an MPTS stream.
2. In the **Inputs** page, click the newly created input stream that you want to demux.
3. Click the action  button on the right end of the selected row and then **Edit**. The Edit input stream name window is displayed.

Broadcaster Inputs

Demuxing an MPTS Stream

4. Select the **Demux MPTS** checkbox.
A list of included programs is displayed.

Program#	Name	Provider	Assigned input
1			
4			
5			
6			
7			
8			
9			
10			
11			
12			
...			

5. Click **Add Program** on the program that you want to create a separate SPTS input stream.

An **Add Input** screen opens with the new SPTS input details, including a suggested **Stream ID**, the original MPTS as a Source Stream and the relevant **Program** number.

Program #4 of stream MPTS_example

Stream ID: MPTS_example_program

Max Outputs: Unlimited

Show in Matrix:

Stream parameters

Source stream: MPTS_example

Program: 4

Max bitrate [kbps]:

Enable time shift

Transmit as multicast

Enable encryption

Recording parameters

Ok Cancel

6. In the **Max Bitrate** field, specify the maximum bitrate of the stream. This is used for internal memory allocation and will not affect the transmitted bitrate. Recommended: double the bitrate of the highest bitrate stream.
7. Configure additional parameters as necessary.
8. Click **OK**.
The channel is assigned an input:

Broadcaster Inputs

Viewing TR101 Analysis

Push Pull UDP Delayed File RTMP RTSP HLS TS over HTTP

Stream parameters

Path: ...

Enable time shift

Transmit as multicast

Enable encryption

Demux MPTS

Program#	Name	Provider	Assigned input
1			
4			MPTS_example_program_4
5			
6			
7			

9. Repeat steps 5-8 to add more programs.

10. Click **OK**.

The newly created MPTS input stream and the related SPTS input streams will appear in the Inputs list.

STATUS INPUTS OUTPUTS ADAPTIVE VOD FILES TRANSCODER SETTINGS EVENT LOG MATRIX LOGOUT

Inputs

Status	ID	Type	Source	Bitrate[kbps]	Up Time	TR 101 290	Error	Outputs	Actions
Connecting	mpts2	Pull	demo.zixi.com:2088	0	00:00:00	Off	No Source	0	<input type="button" value="x"/> <input type="button" value="p"/>
Connected	MPTS_example	File	Curtis/MC_HD_Audio_Channels.ts	19025	04:01:31	Off	None	0	<input type="button" value="+"/> <input type="button" value="x"/>
Connected	MPTS_example_program...	SPTS	MPTS_example.Program#4	497	00:07:15	Off	None	0	<input type="button" value="+"/> <input type="button" value="x"/>
Connected	Music_Choice_MPTS	File	Curtis/MC_HD_Audio_Channels.ts	19010	136:38:52	<input checked="" type="checkbox"/> P1: <input checked="" type="checkbox"/> P2:	None	1	<input type="button" value="+"/> <input type="button" value="x"/>

Viewing TR101 Analysis

TR101 analysis can be added to an input stream for the monitoring of the TS while in operation. The analysis can be used to check the integrity of the TS, as well as perform content analysis to identify frozen video, blank picture, silent audio, low video quality and audio clipping. The TR101 analysis covers priority 1 and 2 messages.

To enable the TR101 analysis follow the instructions in the [Adding TR101 Analysis to the Input Stream](#) section. After enabling the analysis, the stream will include the P1 (high priority error) and P2 (low priority error) status, indicating is there are P1 or P2 messages.

To open the analysis window, click the stethoscope () icon.

The TR101 Analysis window includes the following elements:

Broadcaster Inputs

Viewing TR101 Analysis

The screenshot shows a software interface for stream analysis. On the left, a tree view under 'Stream information statistics' shows:

- Status: TR101 performance drops: 0, CQA performance drops: 0, Error: None
- PAT: Min bitrate: 14kbps (0.1%), Max bitrate: 14kbps (0.1%), Avg bitrate: 14kbps (0.1%), CC errors: 0, Scrambled: 0, Packets: 850168
- NULL: Min bitrate: 0kbps (0%), Max bitrate: 0kbps (0%), Avg bitrate: 0kbps (0%), Packets: 0
- Programs: Program #1, PMT PID: 32 (0x20), Min bitrate: 28kbps (0.2%), Max bitrate: 28kbps (0.2%), Avg bitrate: 28kbps (0.2%), CC errors: 0, Packets: 840841

The main table displays error indicators:

Indicator	#Errors	Last error	Error message
Priority 1			
TS_sync_loss	0	--	--
Sync_byte_error	0	--	--
PAT_error	0	--	--
Continuity_count_error	0	--	--
PMT_error	0	--	--
PID_error	0	--	--
Priority 2			
Transport_error	0	--	--
CRC_error	0	--	--
PCR_error	0	--	--
PCR_accuracy_error	2466051	2022-Sep-07 13:26:27	PCR accuracy of selected program is not within 500ns. (539427ns) PID:257
PTS_error	0	--	--
CAT_error	0	--	--
Content analysis			
Frozen_video	0	--	--
Blank_picture	0	--	--
Silent_audio	0	--	--
Low_video_quality	6917	2022-Sep-07 13:26:18	Low video quality on PID 256
Audio_clipping	0	--	--

At the bottom right, there are controls: 'Content Analysis: Enable' (dropdown), 'Refresh', 'Reset', and 'Close' buttons. Labels on the right side of the interface indicate 'P1/P2 Errors', 'Content analysis errors', and 'Analysis Controls'.

Stream Information Statistics Panel

The stream information statistics panel displays the following accumulative statistics about the stream:

Parameter	Description
Status	
TR101 performance drops	
CQA performance drops	Specify the UDP port to be used for streaming the video.
Error	Specify the UDP port to be used for streaming the audio.
PAT	The Program Association Table (PAT), which only appears in PID 0x0000 packets, tells the decoder what programs are in the TS and points to the Program Map Tables (PMT) which in turn point to the component video, audio and data streams that make up the program. If the PAT is missing then the decoder can do nothing, no program is decodable.
Min bitrate	The minimum bitrate of the PAT packets
Max bitrate	The maximum bitrate of the PAT packets

Broadcaster Inputs

Viewing TR101 Analysis

Avg bitrate	The average bitrate of the PAT packets
CC errors	Indicates if continuity count errors were found. For this indicator three checks are combined. The preconditions "Incorrect packet order" and "Lost packet" could cause problems for IRD which are not equipped with additional buffer storage and intelligence. It is not necessary for the test equipment to distinguish between these two preconditions as they are logically OR-ed, together with the third precondition, into one indicator.
Scrambled	Indicates if the packet is encrypted.
Packets	The number of packets which are related to the PAT (with the same PID – 0)
NULL	Null (stuffing) packets. In order to ensure that the stream maintains a constant bitrate, a multiplexer may need to insert some additional packets. The PID 0x1FFF is reserved for this purpose. The payload of null packets is all zeroes, and the receiver is expected to ignore its contents. Null packets are indicated by PID 8191 (all 1s)
Min bitrate	The minimum bitrate of the NULL packets
Max bitrate	The maximum bitrate of the NULL packets
Avg bitrate	The average bitrate of the NULL packets
Packets	The number of packets which are related to NULL (with the same PID 8191)
Programs	The Transport Stream can include one program (SPTS) or multiple programs (MPTS). Every program is described by a program map table (PMT). The elementary streams associated with that program have PIDs listed in the PMT. Another PID is associated with the PMT itself.
PMT PID	Indicates the PID number of the program map table PMT
Min bitrate	The minimum bitrate of the packet which is related to the PMT PID
Max bitrate	The maximum bitrate of the packet which is related to the PMT PID
Avg bitrate	The average bitrate of the packet which is related to the PMT PID
CC errors	Indicates if continuity count errors were found in the packets that are related to the PMT PID. For this indicator three checks are combined. The preconditions "Incorrect packet order" and "Lost packet" could cause problems for IRD which are not equipped with additional buffer storage and intelligence. It is not necessary for the test equipment to distinguish between these two preconditions as they are logically OR-ed, together with the third precondition, into one indicator.
Packets	The number of packets which are related to the PMT PID
PCR PID	Indicated the PID value that includes the program clock reference (PCR). The PCR is used to enable a decoder to present synchronized content, such as audio tracks

Broadcaster Inputs

Viewing TR101 Analysis

	matching the associated video.
PCR	Indicates the program clock reference (PCR) value.
Accuracy	Indicates the difference between the actual PCR value and the value it should have in the TS represented by the byte index for its actual position. For example, if the calculated PCR (derived from adding the value to the previous packet) is the same as the actual PCR value, the Accuracy value will be '0'.
Deviation	Indicates the frequency deviation.
Delay	Indicates the delay in delivery.
OJ max	Indicates the maximal Overall Jitter, which are variation in delays.
OJ Dev	Indicates the deviation in the overall jitter.
Interval	
Bitrate	The bitrate of the specific PCR PID packets.
Elementary PIDs	<i>Below the Elementary PIDs level are all the different programs that are included in the stream.</i>
Type	The type of program.
Aligned PES	
Min Bitrate	The minimum bitrate of the packet which is related to the Elementary PID
Max Bitrate	The maximum bitrate of the packet which is related to the Elementary PID
Avg Bitrate	The average bitrate of the packet which is related to the Elementary PID
Declared Bitrate	The bitrate value which that was set on the encoder. (H264 streams only)
HDR Buffer Size	The HRD buffer size that was set on the encoder. (H264 streams only)
CC errors	Indicates if continuity count errors were found in the packets that are related to the Elementary PID.
Scrambled	Indicates if the packet is encrypted. Possible values include: Not scrambled, scrambled with even key, scrambled with odd key.
PIC Timing	Indicates the time as it is appears in the last PIC Timing SEI message. (H264 streams only)
PTS	The Presentation Time Stamp (PTS) that the analyzer has captured on the Element stream. The PTS is only accessible if the TS is not scrambled
DTS	The Decode Time Stamp (DTS) that the analyzer has captures on the Element stream. The Decode Time Stamp (DTS) indicates the time at which an access

Broadcaster Inputs

Viewing TR101 Analysis

	unit should be instantaneously removed from the receiver buffer and decoded. It differs from the Presentation Time Stamp (PTS) only when picture reordering is used for B pictures. If DTS is used, PTS must also be provided in the bit stream. PTS (or DTS) is entered in the bitstream at intervals not exceeding 700 mS. ATSC further constrains PTS (or DTS) to be inserted at the beginning of each access unit.
Total Bytes	The total amount of bytes that has passed through the current elementary stream. This includes the Transport Stream Headers.
Packets	The total amount of packets that have passed through the current elementary stream.
Width	The frame resolution width setting.
Height	The frame resolution height setting.
FPS	The Frames Per Second setting.
Interlaced	Indicates whether the video is interlaced or not.
Chroma	Indicates the Chroma Subsampling.
CEA-608/708 captions	A counter that shows how many SEI messages with type 4 (user_data_registered_itu_t_t35) were detected so far. (H264 and HEVC streams only)
Frames	Indicates the number of frames. This indicator is enabled when content analysis is turned on.
Content	Indicates the status of the content. This indicator is enabled when content analysis is turned on. Possible values: <ul style="list-style-type: none">• Live – indicates that there is a difference between two consecutive frames within a period of 30 seconds.• Frozen video – indicates that there is a single frame that is displayed (frozen).• Blank picture – the entire frame is in one color (e.g. black, white, etc.).• Unknown – this status is displayed during the first 30 seconds of the content analysis.
Chroma bit depth	
ePSNR	Estimated PSNR - an estimation of the video quality. values in dB
PSNR	Actual PSNR as calculate by the encoder. available on software transcoded H264 streams only (when user turned it on under the settings tab). values in dB.
Frame Duration max/min/avg	Indicates the maximum, minimum, and average frame duration in milliseconds.

Broadcaster Inputs

Viewing TR101 Analysis

(ms)

GOP Duration

max/min/avg (ms) Indicates the maximum, minimum, and average GOP duration in milliseconds.

GOP structure Indicates the GOP structure, by showing the first 10 frame types in the last GOP. For the example, IPBBBBPBBBP.

Language

Sample rate

Reported Channels

Content

Channel 1

Channel 2

P1/P2 Errors

The P1/P2 errors panel displays data about Priority 1 and Priority 2 errors that were found in the stream during the analysis. The table displays the following information for each error:

- **Indicator** – the indicator for which the error was generated.
- **#Errors** – the total number of errors that were generated.
- **Last error** – the time in which the last error was generated.
- **Error message** – the message that was generated with the error.

The statistics regarding the following Priority 1 and Priority 2 errors are displayed.

Parameter	Description
Priority 1	
TS_sync_loss	Indicates a loss of synchronization with the TS. When 5 sync bytes have been acquired, the decoder is considered synched, but a loss of just 2 sync bytes indicates a loss of sync.
Sync_byte_error	If the sync byte is not equal to 47 hexidecimals, then a sync byte error occurs. The system then looks for the reoccurrence of the sync byte (which must be 47 hexadecimals) every 188 bytes.

Broadcaster Inputs

Viewing TR101 Analysis

PAT_error	The program association table (PAT) is the only packet with packet ID (PID) Hex 0000, and it must occur at least every 0.5s to keep this error from occurring. Every program within the TS is listed in the PAT; if it is missing, then no programs can be decoded
Continuity_count_error	This error occurs when any of the following faults happen — incorrect packet order, a packet occurs more than twice or a packet is lost.
PMT_error	This error can occur if the program map table (PMT) does not come up at least every 0.5s on the PID that is referred to in the PAT.
PID_error	When TSEs are remultiplexed, this can occur if any PID doesn't refer to an actual data stream.
Priority 2	
Transport_error	This flag is set in the TS header by the demodulator if it can't correct errors in the stream.
CRC_error	This indicates that a CRC error (data corruption) occurred in any of the following tables — CAT, PAT, PMT, NIT, EIT, BAT, SDT or TOT.
PCR_error	This flag is raised if the primary clock reference (PCR) is not seen for more than 100ms. The time interval between two consecutive PCR values should be no more than 40ms. This type of error can cause the decoder to lose lock on the 27MHz clock.
PCR_accuracy_error	This error can occur when the PCR accuracy of the selected program is outside the range of ± 500 ns.
PTS_error	This occurs when the presentation time stamp (PTS) repetition is more than 700ms. The PTS is contained in the MPEG-2 program stream and is used to aid the decoder in presenting the program on time, at the correct speed and synchronized. The PTS is compared to the PCR.
CAT_error	This is used for conditional access programs (paid programming).

Content Analysis

The Content Analysis errors panel displays that were found in the stream as part of Zixi's content analysis. To see this table, you must enable the content analysis, by following the instructions in the [Enabling Content Analysis](#) section. The table displays the following information for each error:

- **Indicator** – the indicator for which the error was generated.
- **#Errors** – the total number of errors that were generated.
- **Last error** – the time in which the last error was generated.
- **Error message** – the message that was generated with the error.

Broadcaster Inputs

Viewing TR101 Analysis

Parameter	Description
Frozen_video	Occurrence of frozen video, i.e. no motion, for a duration of approximately 60s or longer.
Blank_picture	Occurrence of blank frames of any color for a duration of approximately 60s or longer.
Silent_audio	Occurrence of silence (dBFS < -90) on AAC or MPEG audio with a duration of about 30s or longer.
Low_video_quality	The estimated video quality, which is based on the Peak signal-to-noise ratio (PSNR) is below the 20dB threshold and therefore considered as poor.
Audio_clipping	Occurrence of clipped audio upon occurrence on AAC or MPEG audio.

Enabling Content Analysis

Zixi's content analysis is performed on I-frames only.

➔ To enable content analysis:

1. Add TR101 Analysis to an input stream. See [Adding TR101 Analysis to the Input Stream](#)
2. Click the stethoscope icon shown in the TR 101 290 column. The Stream Analysis screen is displayed.
3. On the Stream Analysis screen, select **Enable**.

Broadcaster Outputs

Zixi Broadcaster supports the following output types:

- **UDP** – Target is a UDP or RTP stream, over unicast or multicast.
- **RTMP** – Real Time Messaging Protocol streams can be played on systems that accept this protocol as input. Originally designed to enable Adobe® Flash® streams to be sent between a server and a client, RTMP has become a popular protocol for streaming into content-delivery networks (CDNs).
- **RTMPS** – RTMP over a TLS/SSL connection.
- **Pull Stream** – Pull streams are Zixi protocol streams destined for Zixi Receivers. Zixi Broadcaster can offer status and statistics for a stream that is being pulled from it by another device. **You normally do not need to set up a Pull output stream in Zixi Broadcaster.** If your application uses Zixi Receiver, you should configure the stream as input on Zixi Receiver and point it to the IP address and output port (default 2077) of the Zixi Broadcaster. Zixi Receiver will pull the stream and automatically create the proper output definition in the Zixi Broadcaster.
- **Push Stream** – Push streams are Zixi protocol streams destined for other Zixi Broadcasters and “Accept mode” Zixi Receivers.
- **TCP** – TCP protocol provides reliable transmission guarantee for no loss of frame. Its bandwidth probing and congestion control will attempt to use all of the available bandwidth between the server and client, fetching content as quickly as possible while being friendly to other (TCP) traffic on the same links. Output streams can be pushed to one Zixi Broadcasters or Zixi Receiver.
- **HTTP Push** – The HTTP Push output stream can be encapsulated in HLS or DASH. The source of the output stream is a predefined adaptive group that has been configured in the **Adaptive Groups** screen. The configuration of the stream includes the option to delete outdated stream fragments on the server. Output streams can be pushed to one Zixi Broadcasters or Zixi Receiver.
- **AWS** – The HTTP output stream, which is encapsulated in HLS or DASH/fMP4 HLS can be pushed to either an AWS S3 Bucket or to an AWS Elemental MediaStore. The native AWS support includes the ability to configure the S3 authentication credential, including the Region, Access Key, and Secret Key.
- **SRT** – The SRT output can be pulled to/from an SRT-enabled device and is configured via Zen Master or Zixi API only. SRT stands for ‘Secure Reliable Transport’ and is an open-source video transport protocol and technology stack. SRT uses secure streams and easy firewall traversal to optimize streaming performance and deliver high-quality video over even the most unreliable networks.
- **SRT Client** – The SRT Client output can be pushed to an SRT-enabled device and is configured via Zen Master or Zixi API only. SRT stands for ‘Secure Reliable Transport’ and is an open-source video transport protocol and technology stack. SRT uses secure

Adding Outputs

streams and easy firewall traversal to optimize streaming performance and deliver high-quality video over even the most unreliable networks.

- **RIST** – The RIST output can be pushed or have them pulled to/from a RIST-enabled device. RIST seeks to provide reliable, high performance media transport by using UDP at the transport layer to avoid the inefficiencies of TCP, then layering on top Forward Error Correction and Retransmits to add the reliability inherently absent from UDP.

When Zixi Receiver pulls a stream, a Pull stream definition is generated automatically in Zixi Broadcaster, the stream is identified in the Name and Destination columns of Zixi Broadcaster with the ID and IP address of the Zixi Receiver that pulls the stream.

Automated Output Configuration with Output Templates

Instead of manually creating an output and then connecting the output to an input, you can define output templates with rules for automatic creation of outputs with predefined settings. The template includes an Input pattern. When an input pattern matches the pattern of an incoming input stream, the output is created automatically. For more information about Output Templates, see [Using Output Templates](#).

Adding Outputs

Zixi Broadcaster enables you to add various types of outputs. When you create a new output, select the output type and then fill in the fields that are applicable for that output type.

Adding UDP Outputs

This enables the Broadcaster to send a UDP stream. The UDP stream is not protected by the Zixi protocol. The UDP streams can be one of the following types:

- UDP – plain UDP
- RTP – Real-Time Transport Protocol
- RTP + SMPTE 2022 FEC - SMPTE 2022 standard with Forward Error Correction

➔ To Create a UDP Output:

1. In the Zixi Broadcaster **Outputs** page, click . The **New output** window is displayed.
2. Type in the unique identifier for this output in the **Output Name**.
3. Select an **Input Stream** to be made available on this output from the drop-down list.
4. Select the **Show in Matrix** check box to display this stream in the Matrix (see [Using the Matrix](#)). Default: Selected.

Broadcaster Outputs

Adding Outputs

5. Select **UDP**.

New output

Output Name:

Input Stream:

Show in Matrix:

UDP RTMP Pull Push TCP HTTP Push AWS SRT SRT Client RIST

Output parameters

Host:

Port: TTL:

Smoothing [ms]:

RTP:

Bind to IP:

Local port:

Billing Codes

Remultiplex/Pad

Enable decryption

Enable IFB/Talkback

Ok Cancel

- Specify the **Output parameters** (see Output Stream Parameters Table).
- If you want to specify **Billing Codes** to identify and differentiate traffic on a Zixi Broadcaster for billing purposes, select this checkbox (see Output Stream Parameters Table below)
- If you want to remux the stream to CBR (used for professional IRDs) in order to avoid bandwidth waste or add NULL packets and adjust the stream clock (PCR) in order to make the stream CBR, select Remultiplex/Pad and configure the respective parameters (see Output Stream Parameters Table).
- Click **OK**.
The new UDP Output with its settings is created and now appears on the **Outputs** screen.

Output Stream Parameters Table

Parameter	Description
Output Parameters	
Host	Specify the destination IP address or URL.
Port	Specify the target UDP port.
TTL	Specify the time-to-live (TTL). Used mainly to limit the range (or “scope”) of a multicast transmission. Leaving it as blank uses the default value specified by the operating system.
Smoothing	Enables transmission of the output at the correct rate. Required when the receiving

Broadcaster Outputs

Adding Outputs

[mms]	device is sensitive and can't lock on to the stream (in such a case, the recommended latency is 100 - 1000 ms).
--------------	---

RTP	Enables use of the Real-time Transport Protocol.
------------	--

Disables the FEC or specify the type of FEC matrix to D1/ D2.



This setting can be modified without interrupting an existing stream.

In the SMPTE-2022 FEC standard, 1-D and 2-D parity codes are systematic FEC codes of decent complexity that provide protection against bursty or random losses. To enable SMPTE-2022 FEC (Forward Error Correction) select one of the following parity options from the drop-down menu:

SMPTE 2022 FEC (RTP Enabled):

- **1D** (single dimension FEC) - SMPTE-2022 1D can fix a problem in ONE packet per row. This means that the number of rows specified should consider the packet loss rate- the shorter the row, the more error resilience can be achieved on the expense of bitrate level. However, longer rows increase the delay that the FEC will add. It is recommended to select this option when the packet loss is sporadic.

The stream will occupy the source port and two ports above it (e.g. if the source port is 8988, it will occupy 8990).

- **2D** - SMPTE-2022 2D uses a table of packets, which includes rows and columns. This option is more error resilient, but it increases the delay by (row*column) packets and increases the bitrate with R+C packets per each table of R*C packets. It is recommended to select this option when packet loss is bursty.

The stream it will occupy four ports above (e.g. if the source port is 8988, it will occupy 8992).

Bind to IP	Select from the drop-down list the local IP address to be used for this Output, OR select <i>Any</i> to enable any IP to be used.
-------------------	---

Local Port	Specify from which local port to source the stream, if desired (instead of randomly chosen by the operating system).
-------------------	--

Billing Codes

Billing codes are used to identify and differentiate traffic on a Zixi Broadcaster for billing purposes. When a billing code is added to a Source or Target, Zixi can track the traffic on that Broadcaster input or output separately from other inputs and outputs on the same Broadcaster. Billing codes are created by Zixi personnel on the Zixi Customer Portal for a particular organization.

Billing Code	Enter the billing code that corresponds to this stream. The relevant billing can be obtained from the organization that received the billing code from Zixi.
---------------------	--

Broadcaster Outputs

Adding Outputs

Billing password	Enter the password that corresponds to this billing code.
Remultiplex/Pad	Select this checkbox to enable remuxing from VBR MPEG-TS to MPEG-TS CBR (used for professional IRDs) or padding with null packets.
Mode	Select one of the following: <ul style="list-style-type: none">• Pad – adds NULL packets and adjusts the stream clock (PCR) in order to make the stream CBR.• Remultiplex - performs demux->mux and rebuilds the stream according to the below parameters.
Target bitrate [kbps]	Specify the CBR bitrate to target for the padded stream (Pad) or a re-multiplexed stream (remultiplex).
Buffer Size [ms]	Specify maximal difference between DTS and PCR. relevant only for remultiplex mode.
No NULL Packets	Select this option to re-multiplex the stream to CBR but remove the NULL packets in order to maintain low bitrate.
Enable Decryption	Select this checkbox to decrypt an encrypted stream.
Decryption type	<p>If the stream has been encrypted, you can decrypt through the output by selecting this checkbox and specifying the type of encryption that was used.</p> <p>Select Automatic to decrypt a stream that has been encrypted using Automatic encryption.</p> <p>Only if the stream has not been encrypted, select None (default).</p> <p>Important Notice: if the stream has been encrypted you must decrypt it in the output.</p>
Decryption key	If the decryption type includes a key, enter the key to decrypt the stream during output.
Enable IFB/Talkback	Select this checkbox to enable IFB/Talkback for one-way communication from the director or assistant director to on-air talent or a remote location. Selecting the checkbox allows the decoder with a Zixi Receiver to send audio back to the encoder with a Zixi Feeder. This offers the ability to, for example, give audio feedback to the camera operator.
Port	The port that will be used to send the audio feedback.

Broadcaster Outputs

Adding Outputs

Adding RTMP and RTMPS Outputs

Real Time Messaging Protocol streams can be played on systems that accept this protocol as input. Originally designed to enable Adobe® Flash® streams to be sent between a server and a client, RTMP has become a popular protocol for streaming into content-delivery networks (CDNs).



To create an RTMPS output, select the RTMP output option but make sure `rtmps://` url is used in the URL field.



SCTE-35 markers in MPEG-TS streams trigger OnCuePoint call function in RTMP.

➔ To create an RTMP Output:

1. In the Zixi Broadcaster **Outputs** page, click **+ New Output**. The **New output** window is displayed.
2. Type the unique identifier for this output in the **Output Name**.
3. Select an **Input Stream** to be made available on this output from the drop-down list.
4. Select the **Show in Matrix** check box to display this stream in the Matrix (see [Using the Matrix](#)). Default: Selected.
5. Select **RTMP**.

New output

Output Name:

Input Stream:

Show in Matrix:

UDP RTMP Pull Push TCP HTTP Push AWS SRT SRT Client RIST

Output parameters

URL (rtmp://host[:port]/app):

Backup URL:

Stream name:

Username:

Password:

Bitrate [kbps]:

Reconnect [sec]:

Bind to IP:

Send timecode:

Disconnect if inactive:

Ignore TLS certificate errors:

Billing Codes

Enable decryption

Ok Cancel

6. Specify the **Output parameters** (see Output Stream Parameters Table).

Broadcaster Outputs

Adding Outputs

7. If you want to specify **Billing Codes** to identify and differentiate traffic on a Zixi Broadcaster for billing purposes, select this checkbox (see Output Stream Parameters Table below)
8. Click **OK**.
The new RTMP Output with its settings is created and now appears on the screen.

Output Stream Parameters Table

Parameter	Description
Output Parameters	
URL	Specify the destination Stream URL according to the following format: <code>rtmp://host:[port]/app</code> . You can define RTMPS clients with the proven security of a secure socket layer (SSL), by using the <code>rtmps://</code> url. Note that Facebook currently supports RTMPS streams only.
Backup URL	Enter a backup URL (fallback mode) – will be used in case the primary server is not responsive.
Stream Name	Specify the unique name for the stream that the RTMP server at the other end of the connection expects.
Username	Specify the Username to authenticate on the remote RTMP server
Password	Specify the string that is used for authorization on the remote RTMP server.
Bitrate (kbps)	Specify the actual bitrate in kbps or the maximum stream bitrate in case of a VBR stream.
Reconnect (sec)	If the stream drops, this value represents the time between reconnection attempts (in seconds). Default: 5.
Send Timecode	Converts the MPEG-TS SEI section to RTMP ONFI command (pass the encoder timecodes to the RTMP server)
Disconnect if inactive	Select this checkbox to disconnect if the stream if not active for 30 seconds.
Ignore TLS certificate errors	Select this option when streaming to a trusted server that does not have a valid certificate. When this option is selected, Zixi Broadcaster will ignore the TLS certificate errors and transmit the stream to its destination.
Billing Codes	Billing codes are used to identify and differentiate traffic on a Zixi Broadcaster for billing purposes. When a billing code is added to a Source or Target, Zixi can track the traffic on that Broadcaster input or output separately from other inputs and outputs on the same Broadcaster. Billing codes are created by Zixi personnel on the Zixi Customer Portal for a particular organization.

Broadcaster Outputs

Adding Outputs

Billing Code	Enter the billing code that corresponds to this stream. The relevant billing can be obtained from the organization that received the billing code from Zixi.
Billing password	Enter the password that corresponds to this billing code.
Enable Decryption	Select this checkbox to enable decryption of an encrypted stream.
Decryption type	<p>If the stream has been encrypted, you can decrypt through the output by selecting this checkbox and specifying the type of encryption that was used.</p> <p>Select Automatic to decrypt a stream that has been encrypted using Automatic encryption.</p> <p>Only if the stream has not been encrypted, select None (default).</p> <p>Important Notice: if the stream has been encrypted you must decrypt it in the output.</p>

Adding Pull Outputs

The error recovery techniques implemented in the Zixi protocol Pull streams are protected under U.S. patent 11,546,615.

➔ To Create a Pull Output:

1. In the Zixi Broadcaster **Outputs** page click **+ New Output**. The **New Output** window is displayed.
2. Type in the unique identifier for this output in the **Output Name**.
3. Select an **Input Stream** to be made available on this output from the adjacent drop-down list.
4. Select the **Show in Matrix** check box to display this stream in the Matrix (see [Using the Matrix](#)). Default: Selected.
5. Select **Pull**.

New output [Close]

Output Name:

Input Stream:

Show in Matrix:

UDP RTMP Pull Push TCP HTTP Push AWS SRT SRT Client RIST

Output parameters

Stream ID:

Remote ID:

Password:

Latency [ms]: Remote configuration

Billing Codes

Enable encryption

Enable IFB/Talkback

Ok Cancel

Broadcaster Outputs

Adding Outputs

6. Enter the **Output Parameters** (see Output Stream Parameters Table).
7. If you want to specify **Billing Codes** to identify and differentiate traffic on a Zixi Broadcaster for billing purposes, select this checkbox (see Output Stream Parameters Table below)
8. Click **OK**.

The new Pull Output with its settings is created and now appears on the screen.

Output Stream Parameters Table

Parameter	Description
Output Parameters	
Stream ID	Specify the unique Stream ID that the remote Zixi Receiver/Broadcaster expects (recommended – identical to 'Input Stream').
Remote ID	Specify the Zixi Receiver/Broadcaster ID (shown in the Zixi Receiver/Broadcaster Status window) that will be allowed to pull the stream.
Password	Specify a string that can be used to authenticate that the Zixi Receiver is authorized to pull this stream (Optional).
Latency [ms]	Specify the buffer size that Zixi Broadcaster will be able to maintain for error correction. For example, 6000 milliseconds would ensure that the stream is protected for six seconds of errors in the network. Default: Remote configuration. Remote configuration – use the latency configured in the Zixi Receiver/Broadcaster. Otherwise use a value to override the value configured in the Zixi Receiver/Broadcaster.
Billing Codes	Billing codes are used to identify and differentiate traffic on a Zixi Broadcaster for billing purposes. When a billing code is added to a Source or Target, Zixi can track the traffic on that Broadcaster input or output separately from other inputs and outputs on the same Broadcaster. Billing codes are created by Zixi personnel on the Zixi Customer Portal for a particular organization.
Billing Code	Enter the billing code that corresponds to this stream. The relevant billing can be obtained from the organization that received the billing code from Zixi.
Billing password	Enter the password that corresponds to this billing code.
Enable Encryption	Select this checkbox to encrypt the Output stream.

Broadcaster Outputs

Adding Outputs

Encryption type (for Encryption enabled)	Specify the type of Encryption (AES 128/192/256). Click Generate to generate an encryption key or enter another encryption key.
Enable IFB/Talkback	Select this checkbox to enable IFB/Talkback for one-way communication from the director or assistant director to on-air talent or a remote location. Selecting the checkbox allows the decoder with a Zixi Receiver to send audio back to the encoder with a Zixi Feeder. This offers the ability to, for example, give audio feedback to the camera operator.
Port	The port that will be used to send the audio feedback.

Adding Push Outputs

Output streams can be pushed to one or more Zixi Broadcasters and Zixi Receivers. You can specify multiple destinations (Broadcasters/Receivers) by adding them in the Links section. You can also split a single stream using multiple links and then bond them into a single stream in target Zixi Broadcaster using the Bond Links feature. For each of these links, you can specify the max bitrate that can be used. In addition, some links may be specified as backups. The backup links will be used if the bandwidth across all the non-backup links are not enough for the stream (i.e. if a non-backup link is not available, it will not use the backup). Only if the accumulated bandwidth of non-backup links is not enough, then the Broadcaster will stream to a backup link.

The error recovery techniques implemented in the Zixi protocol Push streams are protected under U.S. patent 11,546,615.

➔ To Create a Push Output:

1. In the Zixi Broadcaster **Outputs** page, click . The **New Output** window is displayed.
2. Type in the unique identifier for this output in the **Output Name**.
3. Select an **Input Stream** to be made available on this output from the adjacent drop-down list.
4. Select the **Show in Matrix** check box to display this stream in the Matrix (see [Using the Matrix](#)). Default: Selected.

Broadcaster Outputs

Adding Outputs

5. Select **Push**.

New output

Output Name:

Input Stream:

Show in Matrix:

UDP RTMP Pull Push TCP HTTP Push AWS SRT SRT Client RIST

Output parameters

Links

Host	Port	IP	
<input type="text"/>	2088	Any	<input type="button" value="+"/>
Bond Links: <input type="checkbox"/>			<input type="button" value="x"/>

Stream ID:

Password:

Max latency [ms]:

Ignore TLS certificate errors:

Billing Codes

Enable encryption

Enable IFB/Talkback

Ok Cancel

6. Do one of the following:

- **Stream to multiple destinations** - you can stream the same identical stream to multiple destinations by entering the destination parameters and then clicking the "+" button to add another destination (see **Output Stream Parameters Table**).
 - **Bonded link to a single destination** - you can split the stream into multiple links, which will be forwarded to a single Zixi Broadcaster by selecting the **Bond Links** checkbox (see **Using Network Bonding for Hitless Failover**).
7. Enter additional parameters as necessary (see Output Stream Parameters Table)
 8. If you want to specify **Billing Codes** to identify and differentiate traffic on a Zixi Broadcaster for billing purposes, select this checkbox (see Output Stream Parameters Table below)
 9. Click **OK**. The new Push Output with its settings is created and now appears on the screen.

Output Stream Parameters Table

Parameter	Description
Output Parameters	
Links	

Broadcaster Outputs

Adding Outputs

Host	The destination host for the push stream. Note: additional failover destinations can be added by clicking the adjacent “+” button.
Port	Specify the ports to listen on for Push streams. Default: 2088.
IP	Specify the local IP address.
Max Bitrate (for Bond Links enabled)	Relevant for Bond Links option. Specify the max bitrate in Kbps for the specific link.
Bond Links	Click this checkbox to split the stream into multiple links, which will be forwarded to a single Zixi Broadcaster.
Backup (for Bond Links enabled)	Relevant for Bond Links option. Select this checkbox to define the link as a backup. The backup will be used only if the accumulated bandwidth of the non-backup links is not sufficient.
Stream ID	Specify the unique Stream ID that the remote Zixi Broadcaster expects.
Password	Optional - Specify a string to be used at the receiving Zixi Broadcaster to authenticate that the pushing Broadcaster is allowed to push this stream.
Max Latency [ms]	Specify the buffer size that Zixi Broadcaster will keep for error correction. For example, 6000 milliseconds would ensure that the stream is protected for six seconds of errors in the network. Default:6000
Ignore TLS certificate errors	Select this option when streaming to a trusted server that does not have a valid certificate. When this option is selected, Zixi Broadcaster will ignore the TLS certificate errors and transmit the stream to its destination.
Billing Codes	Billing codes are used to identify and differentiate traffic on a Zixi Broadcaster for billing purposes. When a billing code is added to a Source or Target, Zixi can track the traffic on that Broadcaster input or output separately from other inputs and outputs on the same Broadcaster. Billing codes are created by Zixi personnel on the Zixi Customer Portal for a particular organization.
Billing Code	Enter the billing code that corresponds to this stream. The relevant billing can be obtained from the organization that received the billing code from Zixi.
Billing password	Enter the password that corresponds to this billing code.
Enable Encryption	Select this checkbox to encrypt the Output stream.
Encryption type	Specify the type of Encryption (AES 128/192/256). Click Generate to generate an

Broadcaster Outputs

Adding Outputs

(for Encryption enabled) encryption key or enter another encryption key.

Enable IFB/Talkback

Select this checkbox to enable IFB/Talkback for one-way communication from the director or assistant director to on-air talent or a remote location. Selecting the checkbox allows the decoder with a Zixi Receiver to send audio back to the encoder with a Zixi Feeder. This offers the ability to, for example, give audio feedback to the camera operator.

Port

The port that will be used to send the audio feedback.

Broadcaster Outputs

Adding Outputs

Adding TCP Outputs

TCP protocol provides reliable transmission guarantee for no loss of frame. Its bandwidth probing and congestion control will attempt to use all of the available bandwidth between the server and client, fetching content as quickly as possible while being friendly to other (TCP) traffic on the same links. The TCP output can push the stream directly to a TCP socket or to an HTTP server.

➔ To Create a TCP Output:

1. In the Zixi Broadcaster **Outputs** page, click [+ New Output](#). The **New Output** window is displayed.
2. Type in the unique identifier for this output in the **Output Name**.
3. Select an **Input Stream** to be made available on this output from the adjacent drop-down list.
4. Select the **Show in Matrix** check box to display this stream in the Matrix (see [Using the Matrix](#)). Default: Selected.
5. Select **TCP**.

The screenshot shows the 'New output' dialog box. It has a title bar 'New output' with a close button. The main area contains the following fields and controls:

- Output Name:** A text input field.
- Input Stream:** A dropdown menu.
- Show in Matrix:** A checked checkbox.
- Output type selection:** A row of radio buttons: UDP, RTMP, Pull, Push, TCP (selected), HTTP Push, AWS, SRT, SRT Client, RIST.
- Output parameters:** A section with 'Host', 'Port', and 'HTTP' (checked) checkboxes.
- Billing Codes:** A checkbox.
- Enable decryption:** A checkbox.
- Buttons:** 'Ok' and 'Cancel' buttons at the bottom right.

6. Specify the Output parameters (see **Output Stream Parameters** Table).
7. If the target is an HTTP server, select the **HTTP** checkbox. In this case, HTTP headers will be added to the stream.
8. Enter additional parameters as necessary (see Output Stream Parameters Table).
9. Click **OK**. The new TCP Output with its settings is created and now appears on the screen.

Output Stream Parameters Table

Parameter	Description
-----------	-------------

Output	
---------------	--

Broadcaster Outputs

Adding Outputs

<i>Parameters</i>	
Host	The destination host for the stream.
Port	Specify the ports to listen on for TCP streams. Default: 7777.
HTTP	If the target is an HTTP server, select the HTTP checkbox. In this case, HTTP headers will be added to the stream.
Billing Codes	Billing codes are used to identify and differentiate traffic on a Zixi Broadcaster for billing purposes. When a billing code is added to a Source or Target, Zixi can track the traffic on that Broadcaster input or output separately from other inputs and outputs on the same Broadcaster. Billing codes are created by Zixi personnel on the Zixi Customer Portal for a particular organization.
Billing Code	Enter the billing code that corresponds to this stream. The relevant billing can be obtained from the organization that received the billing code from Zixi.
Billing password	Enter the password that corresponds to this billing code.
Enable Decryption	Select this checkbox to enable decryption of an encrypted stream.
Decryption type	<p>If the stream has been encrypted, you can decrypt through the output by selecting this checkbox and specifying the type of encryption that was used.</p> <ul style="list-style-type: none">• Select Automatic to decrypt a stream that has been encrypted using Automatic encryption.• Only if the stream has not been encrypted, select None (default).• Important Notice: if the stream has been encrypted you must decrypt it in the output.
Decryption key	Enter the decryption key to decrypt the encrypted stream.

Adding HTTP Push Outputs

The HTTP Push output stream can be encapsulated in HLS or DASH. The source of the output stream is a predefined adaptive group that has been configured in the **Adaptive Groups** screen. The configuration of the stream includes the option to delete outdated stream fragments on the server. SCTE-35 markers in the source input will be preserved and used to segment the stream for both HLS and DASH encapsulation. Output streams can be pushed to one Zixi Broadcaster or Zixi Receiver.

The path to the destination can be formed in one of the following ways:

- **Full path** – in this option the path would be constructed as follows: `<base url>/<path>/<file>?<additional params may be also with path and file>`
- **Path in parameters** - in this option the path would be constructed as follows: `<base url>?<additional params may be also with path and file>`
- **Flat path** - in this option the path would be constructed as follows: `<base url>/<path>_<file>?<additional params may be also with path and file>`. Any "/" in path should be replaced with "_"

Low Latency HLS - Zixi Broadcaster supports low latency HLS delivery using chunked transfer encoding, which starts sending an HTTP response as chunks of data when they are ready before the complete response is available. Chunked transfer encoding can be used with transport stream (TS) segments and with fragmented MP4 (fMP4). For low latency HLS and DASH, Zixi Broadcaster must be used as an origin server. To enable low latency HLS and DASH, select **Enable HLS Fast playback** on **Settings > Live Protocols** screen.

➔ To Create an HTTP Push Output:

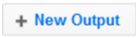
1. In the Zixi Broadcaster **Outputs** page, click . The **New Output** window is displayed.

Broadcaster Outputs

Adding Outputs

2. Select the **HTTP Push** option (radio button).

The screenshot shows the 'New output' dialog box. The 'HTTP Push' radio button is selected. Under 'Output parameters', 'HLS encapsulation' is selected. The 'Target URL' and 'Additional URL parameters' fields are empty. The 'Segment Path' dropdown is set to 'Full path'. The 'Authorization' and 'Billing Codes' checkboxes are unchecked.

3. Type in the unique identifier for this output stream in the **Output Name**.
4. Select an **Input Adaptive Group** to be made available on this output from the adjacent drop-down list. To create an Adaptive Group, see [Adaptive Groups](#).
5. Select the **Show in Matrix** check box to display this stream in the Matrix (see [Using the Matrix](#)). Default: not selected.
6. Enter the **Output Parameters** (see Output Stream Parameters Table).
7. Click **OK**.

Output Stream Parameters Table

Parameter	Description
Output Parameters	
Encapsulation Options	<ul style="list-style-type: none">• HLS Encapsulation - the output stream, which includes all the streams in the selected Adaptive group, will be encapsulated in HTTP Live Streaming format.
	<ul style="list-style-type: none">• Dash Encapsulation - the output stream, which includes all the streams in the selected Adaptive group, will be encapsulated in MPEG DASH format.

Broadcaster Outputs

Adding Outputs

Depending on the selection in the **Segment Path** field below, this field should include the following:

- Target URL**
- **Full path** – `<base url>/<path>/<file>`
 - **Path in parameters** - in this option the path would be constructed as follows: `<base url>`
 - **Flat path** - in this option the path would be constructed as follows: `<base url>/<path>_<file>`
-

Depending on the selection in the **Segment Path** field below, this field should include the following:

- Additional URL parameters**
- **Full path** – `?<additional params may be also with path and file>`
 - **Path in parameters** - `?<additional params may be also with path and file>`
 - **Flat path** - `?<additional params may be also with path and file>`. Any "/" in path should be replaced with "_"

URL parameters support macros as follows:

- %PATH% - file path as it appears in the playlist
 - %FILE% - file name
-

Delete outdated fragments on server

Select this checkbox to delete any outdated stream fragments from the server.

Upload DVR playlist

Select this checkbox if you are streaming a recorded/VOD stream and you want to upload a DVR playlist in addition to the live playlist.

Select one of the following path segmentation types:

- Segment Path**
- **Full path** – in this option the path would be constructed as follows: `<base url>/<path>/<file>?<additional params may be also with path and file>`
 - **Path in parameters** - in this option the path would be constructed as follows: `<base url>?<additional params may be also with path and file>`
 - **Flat path** - in this option the path would be constructed as follows: `<base url>/<path>_<file>?<additional params may be also with path and file>`. Any "/" in path should be replaced with "_"
-

Broadcaster Outputs

Adding Outputs

Ignore TLS certificate errors	Select this option when streaming to a trusted server that does not have a valid certificate. When this option is selected, Zixi Broadcaster will ignore the TLS certificate errors and transmit the stream to its destination.
--------------------------------------	---

Authorization	Select this checkbox if your destination server requires authorization credentials to connect.
----------------------	--

Select one of the following authorization methods:

Method	<ul style="list-style-type: none">• Basic authorization• Digest authorization• OAuth2 authorization
---------------	---

Username	Type the username
-----------------	-------------------

Password	Type the password
-----------------	-------------------

Billing Codes	Billing codes are used to identify and differentiate traffic on a Zixi Broadcaster for billing purposes. When a billing code is added to a Source or Target, Zixi can track the traffic on that Broadcaster input or output separately from other inputs and outputs on the same Broadcaster. Billing codes are created by Zixi personnel on the Zixi Customer Portal for a particular organization.
----------------------	--

Billing Code	Enter the billing code that corresponds to this stream. The relevant billing can be obtained from the organization that received the billing code from Zixi.
---------------------	--

Billing password	Enter the password that corresponds to this billing code.
-------------------------	---

Adding AWS Outputs

The HTTP output stream, which is encapsulated in HLS or DASH/fMP4 HLS can be pushed to either an AWS S3 Bucket or to an AWS Elemental MediaStore. The native AWS support includes the ability to configure the S3 authentication credential, including the Region, Access Key, and Secret Key.

➔ To Create an AWS Output:

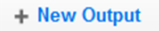
1. In the Zixi Broadcaster **Outputs** page, click . The **New Output** window is displayed.

Broadcaster Outputs

Adding Outputs

2. Select the **AWS** option (radio button).

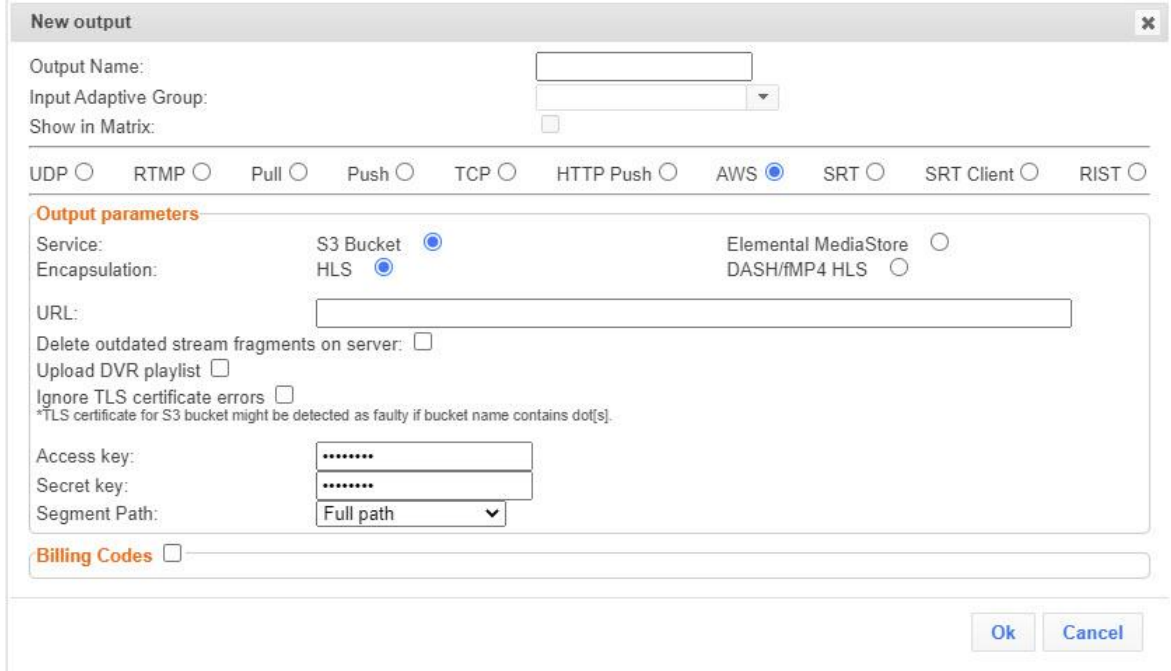

3. Type in the unique identifier for this output stream in the **Output Name**.
4. Select an **Input Adaptive Group** to be made available on this output from the adjacent drop-down list. To create an Adaptive Group, see [Adaptive Groups](#).
5. Select the **Show in Matrix** check box to display this stream in the Matrix (see [Using the Matrix](#)). Default: not selected.
6. Enter the **Output Parameters** (see Output Stream Parameters Table).
7. Click **OK**.

Output Stream Parameters Table

Parameter	Description
Output Parameters	
Service	Select one of the following options: <ul style="list-style-type: none">• S3 Bucket - the output stream will be pushed to the specified S3 Bucket.• Elemental Media Store - the output stream will be pushed to the specified AWS Elemental MediaStore.

Broadcaster Outputs

Adding Outputs

Encapsulation	<ul style="list-style-type: none">• HLS Encapsulation - the output stream, which includes all the streams in the selected Adaptive group, will be encapsulated in HTTP Live Streaming format.• Dash Encapsulation - the output stream, which includes all the streams in the selected Adaptive group, will be encapsulated in MPEG DASH format.
----------------------	--

URL	<p>The URL address of the destination host for the S3 Bucket or the AWS Elemental MediaStore.</p> <p>The path to the destination can be formed in one of the following ways according to the option selected in the Segment Path field below:</p> <ul style="list-style-type: none">• Full path – in this option the path would be constructed as follows: <code><base url>/<path>/<file>?<additional params may be also with path and file></code>• Path in parameters - in this option the path would be constructed as follows: <code><base url>?<additional params may be also with path and file></code>• Flat path - in this option the path would be constructed as follows: <code><base url>/<path>_<file>?<additional params may be also with path and file></code>. Any "/" in path should be replaced with "_"
------------	---

Delete outdated stream fragments on server	Select this checkbox to send delete messages to S3/AWS Elemental MediaStore to delete the outdated stream fragments from the servers.
---	---

Ignore TLS certificate errors	Select this option when streaming to a trusted server that does not have a valid certificate. When this option is selected, Zixi Broadcaster will ignore the TLS certificate errors and transmit the stream to its destination.
--------------------------------------	---

Access key	Enter your AWS S3 or AWS Elemental MediaStore Access key.
-------------------	---

Secret key	Enter your AWS S3 or AWS Elemental MediaStore Secret key.
-------------------	---

Segment Path	<p>Select one of the following path segmentation types:</p> <ul style="list-style-type: none">• Full path – in this option the path would be constructed as follows: <code><base url>/<path>/<file>?<additional params may be also with path and file></code>• Path in parameters - in this option the path would be constructed as follows: <code><base url>?<additional params may be also with path and file></code>• Flat path - in this option the path would be constructed as follows: <code><base url>/<path>_<file>?<additional params may be also with path and file></code>. Any "/" in path should be replaced with "_"
---------------------	--

Broadcaster Outputs

Adding Outputs

Billing Codes	Billing codes are used to identify and differentiate traffic on a Zixi Broadcaster for billing purposes. When a billing code is added to a Source or Target, Zixi can track the traffic on that Broadcaster input or output separately from other inputs and outputs on the same Broadcaster. Billing codes are created by Zixi personnel on the Zixi Customer Portal for a particular organization.
Billing Code	Enter the billing code that corresponds to this stream. The relevant billing can be obtained from the organization that received the billing code from Zixi.
Billing password	Enter the password that corresponds to this billing code.

Adding SRT Outputs

The SRT output can be pulled to/from an SRT-enabled device. SRT stands for ‘Secure Reliable Transport’ and is an open-source video transport protocol and technology stack. SRT uses secure streams and easy firewall traversal to optimize streaming performance and deliver high-quality video over even the most unreliable networks.

➔ To Create an SRT Output:

1. In the Zixi Broadcaster **Outputs** page click . The **New Output** window is displayed.
2. Type in the unique identifier for this output in the **Output Name**.
3. Select an **Input Stream** to be made available on this output from the adjacent drop-down list.
4. Select the **Show in Matrix** check box to display this stream in the Matrix (see [Using the Matrix](#)). Default: Selected.

Broadcaster Outputs

Adding Outputs

5. Select **SRT**.

The screenshot shows a 'New output' dialog box with the following fields and options:

- Output Name: [Text input]
- Input Stream: [Dropdown menu]
- Show in Matrix:
- Protocol selection: UDP, RTMP, Pull, Push, TCP, HTTP Push, AWS, **SRT** (selected), SRT Client, RIST
- Output parameters** section:
 - Listening Port: [Text input]
 - Password[10-80]: [Text input]
 - Latency[ms]: 1000 [Text input]
 - Encryption type: None [Dropdown menu]
 - Bind to IP: Any [Dropdown menu]
- Billing Codes:
- Enable decryption:
- Buttons: Ok, Cancel

6. Enter the **Output Parameters** (see Output Stream Parameters Table).

7. If you want to specify **Billing Codes** to identify and differentiate traffic on a Zixi Broadcaster for billing purposes, select this checkbox (see Output Stream Parameters Table below)

8. Click **OK**.

The new SRT Output with its settings is created and now appears on the screen.

Output Stream Parameters Table

Parameter	Description
Output Parameters	
Listening Port	Specify the port to listen on. This port must be open on all firewalls between the Zixi Broadcaster and other devices it is communicating with.
Password	If the stream is password protected, enter the password.
Latency	Specify the maximum latency of the stream in milliseconds. Default: 1000
Encryption Type	Specify the type of Encryption (AES 128/192/256).
Bind to IP	Select from the drop-down list the local IP address to be used for this output, OR select <i>Any</i> to enable any IP to be used.

Broadcaster Outputs

Adding Outputs

Billing Codes	Billing codes are used to identify and differentiate traffic on a Zixi Broadcaster for billing purposes. When a billing code is added to a Source or Target, Zixi can track the traffic on that Broadcaster input or output separately from other inputs and outputs on the same Broadcaster. Billing codes are created by Zixi personnel on the Zixi Customer Portal for a particular organization.
Billing Code	Enter the billing code that corresponds to this stream. The relevant billing can be obtained from the organization that received the billing code from Zixi.
Billing password	Enter the password that corresponds to this billing code.
Enable Decryption	Select this checkbox to decrypt an encrypted stream.
Decryption type	<p>If the stream has been encrypted, you can decrypt through the output by selecting this checkbox and specifying the type of encryption that was used.</p> <p>Select Automatic to decrypt a stream that has been encrypted using Automatic encryption.</p> <p>Only if the stream has not been encrypted, select None (default).</p> <p>Important Notice: if the stream has been encrypted you must decrypt it in the output.</p>
Decryption key	If the decryption type includes a key, enter the key to decrypt the stream during output.

Adding SRT Client Outputs

The SRT Client output can be pushed to an SRT-enabled device. SRT stands for 'Secure Reliable Transport' and is an open-source video transport protocol and technology stack. SRT uses secure streams and easy firewall traversal to optimize streaming performance and deliver high-quality video over even the most unreliable networks.

➔ To Create an SRT Client Output:

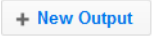
1. In the Zixi Broadcaster **Outputs** page click . The **New Output** window is displayed.
2. Type in the unique identifier for this output in the **Output Name**.
3. Select an **Input Stream** to be made available on this output from the adjacent drop-down list.
4. Select the **Show in Matrix** check box to display this stream in the Matrix (see [Using the Matrix](#)). Default: Selected.

Broadcaster Outputs

Adding Outputs

5. Select **SRT Client**.

The screenshot shows a 'New output' dialog box with the following fields and options:

- Output Name: [Text input field]
- Input Stream: [Dropdown menu]
- Show in Matrix:
- Protocol selection: UDP , RTMP , Pull , Push , TCP , HTTP Push , AWS , SRT , SRT Client , RIST
- Output parameters** section:
 - Host: [Text input field]
 - Port: [Text input field]
 - Password[10-80]: [Text input field]
 - Latency[ms]: [Text input field with value 1000]
 - Encryption type: [Dropdown menu with value None]
- Billing Codes:
- Enable decryption:
- Buttons: Ok, Cancel

6. Enter the **Output Parameters** (see Output Stream Parameters Table).
7. If you want to specify **Billing Codes** to identify and differentiate traffic on a Zixi Broadcaster for billing purposes, select this checkbox (see Output Stream Parameters Table below)
8. Click **OK**.

The new SRT Client Output with its settings is created and now appears on the screen.

Output Stream Parameters Table

Parameter	Description
Output Parameters	
Host	The destination host for the SRT stream.
Port	Specify the ports to which the stream will be pushed.
Password	If the stream is password protected, enter the password.
Latency	Specify the maximum latency of the stream in milliseconds. Default: 1000
Encryption Type	Specify the maximum expected bitrate for memory allocation. Recommended: 2X the actual bitrate, which will prevent buffer overruns (especially with VBR streams). Default: 8000. Note – Overflows will typically occur when the Max Bitrate isn't sufficient.

Broadcaster Outputs

Adding Outputs

Billing Codes	Billing codes are used to identify and differentiate traffic on a Zixi Broadcaster for billing purposes. When a billing code is added to a Source or Target, Zixi can track the traffic on that Broadcaster input or output separately from other inputs and outputs on the same Broadcaster. Billing codes are created by Zixi personnel on the Zixi Customer Portal for a particular organization.
Billing Code	Enter the billing code that corresponds to this stream. The relevant billing can be obtained from the organization that received the billing code from Zixi.
Billing password	Enter the password that corresponds to this billing code.
Enable Decryption	Select this checkbox to decrypt an encrypted stream.
Decryption type	<p>If the stream has been encrypted, you can decrypt through the output by selecting this checkbox and specifying the type of encryption that was used.</p> <p>Select Automatic to decrypt a stream that has been encrypted using Automatic encryption.</p> <p>Only if the stream has not been encrypted, select None (default).</p> <p>Important Notice: if the stream has been encrypted you must decrypt it in the output.</p>
Decryption key	If the decryption type includes a key, enter the key to decrypt the stream during output.

Adding RIST Outputs

The RIST output can be push streams or have them pulled to/from a RIST-enabled device. RIST seeks to provide reliable, high performance media transport by using UDP at the transport layer to avoid the inefficiencies of TCP, then layering on top Forward Error Correction and Retransmits to add the reliability inherently absent from UDP.

Zixi supports the following RIST profiles:

- **Simple Profile (PUSH only)** - The RIST Simple Profile provides best-in-class packet protection, as well as support for multi-link bonding and seamless switching.
- **Main Profile (PUSH/PULL)** – The RIST Main Profile builds upon the features of the Simple Profile to provide backwards compatibility, while opening the door for additional features, including:
 - **Encryption and authentication** - RIST Main Profile uses industry-standard DTLS or PSK with a variety of available cyphers to ensure the most up-to-date protection, while being flexible to accommodate local legal regulations. Support for pre-shared keys is also included, which makes RIST Main Profile compatible with one-to-many environments such as satellite or multicast distribution.

Broadcaster Outputs

Adding Outputs

- **Native tunneling and multiplexing** - the ability to combine multiple Simple Profile RIST streams into one single connection, optionally with one single encryption and authentication step, using industry-standard GRE over UDP.
- **Bandwidth optimization** - by deleting NULL packets at the source and re-inserting them at the destination.
- **Support for high bit rate streams** - The RIST Main Profile includes an RTP header extension which increases the sequence number size to 32-bits, and therefore increases the maximum size of retransmission buffers, and thus opens the door for higher bitrate streams, such as lightly compressed (e.g. JPEG 2000, Tico) and uncompressed video.

Contact your Zixi representative to learn more about interoperability testing between Zixi Broadcaster and 3rd party devices. More details about RIST can be found at www.rist.tv

➔ To Add a RIST Output:

1. In the Zixi Broadcaster **Outputs** page, click **+ New Output**. The **New Output** window is displayed.

The screenshot shows the 'New output' dialog box. It features a title bar with a close button. The main area contains the following elements:

- Output Name:** A text input field.
- Input Stream:** A dropdown menu.
- Show in Matrix:** A checkbox.
- Protocol Selection:** A row of radio buttons for UDP, RTMP, Pull, Push, TCP, HTTP Push, AWS, SRT, SRT Client, and RIST. The RIST option is selected.
- Output parameters:** A section with several fields:
 - Profile:** A dropdown menu set to 'Simple Profile'.
 - Host:** A text input field.
 - Port:** A text input field.
 - TTL:** A text input field.
 - Smoothing [ms]:** A text input field with the value '0'.
 - SMPTE-2022 FEC:** A dropdown menu set to 'Disable'.
 - Bind to IP:** A dropdown menu set to 'Any'.
 - Local port:** A text input field.
- Options:** Four checkboxes: 'Billing Codes', 'Remultiplex/Pad', 'Enable decryption', and 'Enable IFB/Talkback', all of which are currently unchecked.
- Buttons:** 'Ok' and 'Cancel' buttons at the bottom right.

2. Select the **RIST** option (radio button).
3. Type in the unique identifier for this output stream in the **Output Name**.
4. Select an **Input Stream** to be made available on this output from the adjacent drop-down list.
5. Select the **Show in Matrix** check box to display this stream in the Matrix (see [Using the Matrix](#)). Default: not selected.
6. Enter the **Output Parameters** (see Output Stream Parameters Table).

Broadcaster Outputs

Adding Outputs

7. Click **OK**.

The new RIST Output with its settings is created and now appears on the Outputs screen.

Output Stream Parameters Table

Parameter	Description
Output Parameters	
Profile	Select one of the following RIST profiles that matches the input stream: <ul style="list-style-type: none">• Simple Profile (default)• Main Profile
Type (Main Profile)	Select the stream direction: <ul style="list-style-type: none">• Push• Pull
Host	Specify the destination IP address or URL of the host to which the steam will be pushed.
Port	Specify the target UDP port.
TTL	Specify the time-to-live (TTL). Used mainly to limit the range (or “scope”) of a multicast transmission. Leaving it as blank uses the default value specified by the operating system
Smoothing [ms]	Enables transmission of the output at the correct rate. Required when the receiving device is sensitive and can’t lock on to the stream (in such a case, the recommended latency is 100 - 1000 ms)

Broadcaster Outputs

Adding Outputs

In the SMPTE-2022 FEC standard, 1-D and 2-D parity codes are systematic FEC codes of decent complexity that provide protection against bursty or random losses.



This setting can be modified without interrupting an existing stream.

SMPTE-2022 FEC

To enable SMPTE-2022 FEC (Forward Error Correction) select one of the following parity options from the drop-down menu:

- **1D** - SMPTE-2022 1D can fix a problem in ONE packet per row. This means that the number of rows specified should consider the packet loss rate- the shorter the row, the more error resilience can be achieved on the expense of bitrate level. However, longer rows increase the delay that the FEC will add. It is recommended to select this option when the packet loss is sporadic.
The stream will occupy the source port and two ports above it (e.g. if the source port is 8988, it will occupy 8990).
- **2D** - SMPTE-2022 2D uses a table of packets, which includes rows and columns. This option is more error resilient, but it increases the delay by (row*column) packets and increases the bitrate with R+C packets per each table of R*C packets. It is recommended to select this option when packet loss is bursty.
The stream will occupy four ports above (e.g. if the source port is 8988, it will occupy 8992).

Bind to IP

Select from the drop-down list the local IP address to be used for this Input, OR select *Any* to enable any IP to be used.

Local Port

Specify from which local port to source the stream, if desired (instead of randomly chosen by the operating system).

RIST main profile parameters

Use DTLS

Select this option to connect using DTLS, which offers authentication and encryption.

Ignore TLS certificate errors

Select this option when streaming to a trusted server that does not have a valid certificate. When this option is selected, Zixi Broadcaster will ignore the TLS certificate errors and transmit the stream to its destination.

User

Enter the authentication credentials

Password

Enter the authentication credentials

Broadcaster Outputs

Adding Outputs

Billing Codes	Billing codes are used to identify and differentiate traffic on a Zixi Broadcaster for billing purposes. When a billing code is added to a Source or Target, Zixi can track the traffic on that Broadcaster input or output separately from other inputs and outputs on the same Broadcaster. Billing codes are created by Zixi personnel on the Zixi Customer Portal for a particular organization.
Billing Code	Enter the billing code that corresponds to this stream. The relevant billing can be obtained from the organization that received the billing code from Zixi.
Billing Password	Enter the password that corresponds to this billing code.
Remultiplex/Pad	Select this checkbox to enable remuxing from VBR MPEG-TS to MPEG-TS CBR (used for professional IRDs) or padding with null packets.
Mode	Select one of the following: <ul style="list-style-type: none">• Pad – adds NULL packets and adjusts the stream clock (PCR) in order to make the stream CBR.• Remultiplex - performs demux->mux and rebuilds the stream according to the below parameters.
Target bitrate [kbps]	Specify the CBR bitrate to target for the padded stream (Pad) or a re-multiplexed stream (remultiplex).
Enable Decryption	Select this checkbox to decrypt an encrypted stream.
Decryption type	If the stream has been encrypted, you can decrypt through the output by selecting this checkbox and specifying the type of encryption that was used. Select Automatic to decrypt a stream that has been encrypted using Automatic encryption. Only if the stream has not been encrypted, select None (default). Important Notice: if the stream has been encrypted you must decrypt it in the output.
Decryption key	If the decryption type includes a key, enter the key to decrypt the stream during output.
Enable IFB/Talkback	Select this checkbox to enable IFB/Talkback for one-way communication from the director or assistant director to on-air talent or a remote location. Selecting the checkbox allows the decoder with a Zixi Receiver to send audio back to the encoder with a Zixi Feeder. This offers the ability to, for example, give audio feedback to the camera operator.
Port	The port that will be used to send the audio feedback.





Broadcaster Outputs

Viewing Existing Outputs

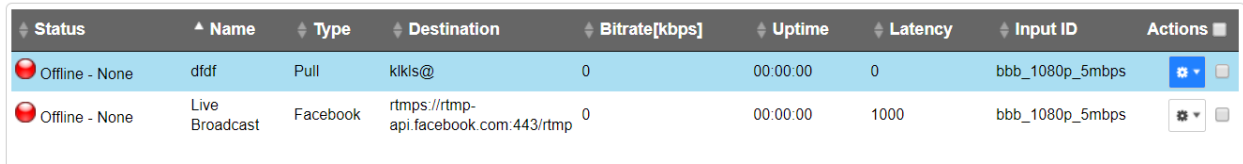
Viewing Existing Outputs

The Outputs screen displays all the output streams that have been created.



Status	Name	Type	Destination	Bitrate[kbps]	Uptime	Latency	Input ID	Actions
Offline - None	dfdf	Pull	kikls@	0	00:00:00	0	bbb_1080p_5mbps	 
Offline - None	Live Broadcast	Facebook	rtmps://rtmp-api.facebook.com:443/rtmp	0	00:00:00	1000	bbb_1080p_5mbps	 

Hovering the cursor on the status indicator of a stream shows the stream configuration information and basic utilization statistics, where applicable.

Any of the columns in the following table can be sorted in ascending/descending order by clicking on its heading. The **Search** text box in the upper left-hand side of the screen can be used to search for a specific input stream by entering the desired Stream ID.

Field	Description
Status	Displays the status of output stream. The following colored indicators are displayed: <ul style="list-style-type: none">• Green = Connected• Yellow = Connecting• Red = Disconnected with an error condition• Blue = Offline with no connection attempts• Grey = Offline and stopped
Name	Displays the name of the output stream, as defined in the Zixi Broadcaster.
Type	Displays the type of output stream.
Destination	Displays the IP address of the host that will be receiving the stream.
Bitrate [kbps]	Displays bitrate of the connected output stream.
Uptime	Displays the amount of time the stream has been active.
Latency	Displays the configured latency
Input ID	The ID of the related Input stream.
Actions	Provides access to various actions to be performed on this output stream (see Performing Actions on Output Streams below).

Broadcaster Outputs

Viewing Existing Outputs

Stats Pane

The Stats pane on the bottom of the page shows data about the activity of the selected stream.

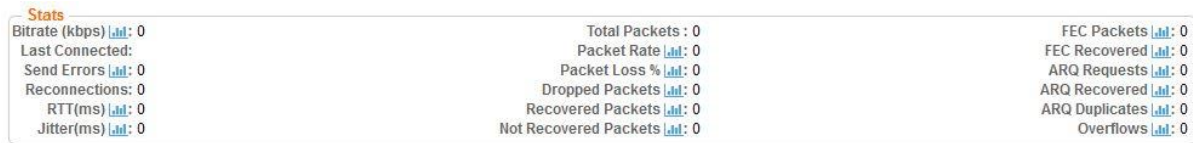

Click the  icon next to a parameter to show the graph of historical data for the specified parameter.

Field	Description
Bitrate (kbps)	Displays the current bitrate of the output stream
Last Connected	Displays the date and time in which the stream was connected.
Bytes sent [MB]	The cumulative traffic transmitted (in MB)
Up Time	Displays the amount of time the stream has been active.
Send Errors	Displays the number of errors generated after sending the stream.
Reconnections	Displays the number of reconnection attempts.
RTT (ms)	Displays the Round Trip Time (RTT) from the source (in milliseconds)
Jitter	Displays the current Jitter, measured in milliseconds.
Congestion [%]	Displays an estimation of the communication's congestion level – '0' means congestion free, '100' means fully congested.
Total Packets	Displays the total number of packets that have been transmitted.
Packet Rate	Displays the current number of packets per second.
Packet Loss %	Displays the packet loss rate (how many packets were lost out of the total number of packets).
Retransmissions	
Dropped Packets	Displays the total number of packets that were dropped since the beginning of the stream.
Recovered Packets	Displays the total number of dropped packets that have been recovered since the beginning of the stream.
Not Recovered Packets	Displays the number of non-recovered packets.
Failed Sends	Displays the number of failed attempts to send the stream.

Broadcaster Outputs

Viewing Existing Outputs

FEC Packets	Displays the number of FEC packets transmitted.
FEC Recovered	Displays the number of FEC packets that were recovered.
ARQ Requests	Displays the number of requests for transmission of dropped packets made with ARQ.
ARQ Recovered	Displays the number of dropped packets recovered via ARQ.
ARQ Duplicates	Displays the number of duplicate recovery packets received via ARQ.
Overflows	Displays the number of packets lost due to buffer overflow. Note: overflow is usually the result of the Max Bitrate being too low.

Searching for Output Streams

➔ To Search for an Output Stream:

In the Zixi Broadcaster **Outputs** page, type in the specific output stream name in the search text box on the left-hand top of the screen and click . The **Output** screen displays the requested output stream(s).

Performing Actions on Output Streams

Every stream has a shortcut button that can be used to perform relevant actions on the stream. The following actions can be performed through the Actions button:

- **Deleting Output Streams from Broadcaster**
- **Switching Input**

Deleting Output Streams from Broadcaster

➔ To Delete an Output Stream from the Broadcaster:

1. In the Zixi Broadcaster **Outputs** page, select the output stream you want to delete, and then click .
2. Click **Delete** to the selected stream. The selected input stream was deleted and is not displayed anymore.

Switching Input

➔ To change the input associated with the selected output:

1. In the Zixi Broadcaster **Outputs** page, click  and select **Switch Input**. The **Switch source** window is displayed.
2. In the **New Input** drop-down, select the desired input, and click **OK**. The newly designated input is now associated with the selected output.

Broadcaster Outputs

Performing Actions on Output Streams

Viewing Traceroutes

You can view traceroute data for a stream sent from a Zixi Broadcaster (v13 or above) to a Zixi Receiver (v13 or above).

➔ To view traceroute data:

1. On the **Outputs** page of Zixi Broadcaster, click the desired row of the output stream for which you want to view traceroutes.
2. Click the  button on the right end of the selected row and then select **Trace**. The traceroute data for this stream is displayed.

Performing Actions on Multiple Outputs

Delete Marked Individual and Multiple Outgoing Stream

➔ To Delete Output Streams:

1. In the Zixi Broadcaster Outputs page, select all outputs by selecting the checking the Actions checkbox at the header line, or select individual outputs by selecting their checkboxes.

The Marked drop-down button is displayed.



2. Click the **Marked** drop-down menu and then click **Delete**.
The selected Output Streams are deleted.

Start and Stop Marked Individual and Multiple Outgoing Streams

➔ To Stop/Start Output Streams:

1. In the Zixi Broadcaster Outputs page, select all outputs by selecting the **Actions** checkbox, located in the header line, or select individual outputs by selecting their checkboxes.

The Marked drop-down button is displayed.



2. Click the **Marked** drop-down menu and then click **Start/Stop**.
The selected Output Streams are started/stopped.

Save Marked Individual and Multiple Outgoing Streams

➔ To Save Output Streams:

1. In the Zixi Broadcaster Outputs page, select all outputs by selecting the **Actions** checkbox, located in the header line, or select individual outputs by selecting their checkboxes.

The Marked drop-down button is displayed.

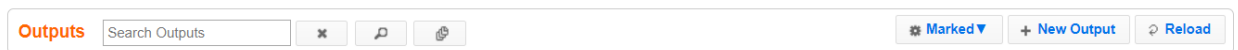

2. Click the **Marked** drop-down menu and then click **Save**.
The selected Output Streams are saved.

Broadcaster Outputs

Using Output Templates

Reset Stats for Individual and Multiple Outgoing Streams

➔ To Reset Output Streams:

1. In the Zixi Broadcaster Outputs page, select all outputs by selecting the **Actions** checkbox, located in the header line, or select individual outputs by selecting their checkboxes.

The Marked drop-down button is displayed.

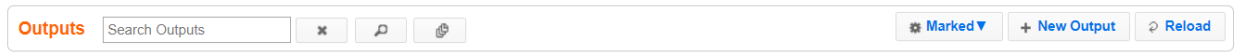

2. Click the **Marked** drop-down menu and then click **Reset**.
The selected Output Streams are reset.

Viewing Traceroutes

For streams sent from Zixi Broadcasters (v13 and above) to Zixi Receivers (v13 and above), you can view traceroute data for this stream.

➔ To view traceroute data:

1. On the **Outputs** page of Zixi Broadcaster, click on the row of the stream for which you want to view traceroutes.
2. Click the  button on the right end of the selected row and then select **Trace**.
3. The traceroute data for this stream is displayed.

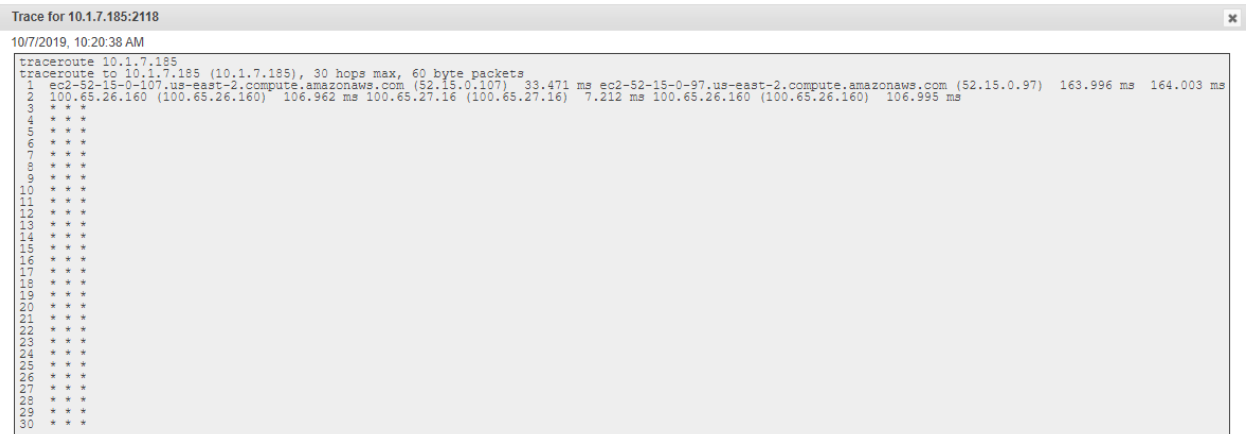

[Refresh](#) [Close](#)

You can refresh the Traceroute data at any time by clicking the **Refresh** button.

Using Output Templates

Instead of manually creating an output and then connecting the output to an input, you can define output templates with rules for automatic creation of outputs with predefined settings. The template includes an Input pattern. When an input pattern matches the pattern of an incoming input stream, the output is created automatically.

Broadcaster Outputs

Using Output Templates

➔ To create a new Output template:

1. Click the **Outputs** tab at the top of the Zixi Broadcaster administrative screen.
2. In the **Menu** bar, click the **Templates** () button.

The **Output Templates** window is displayed:

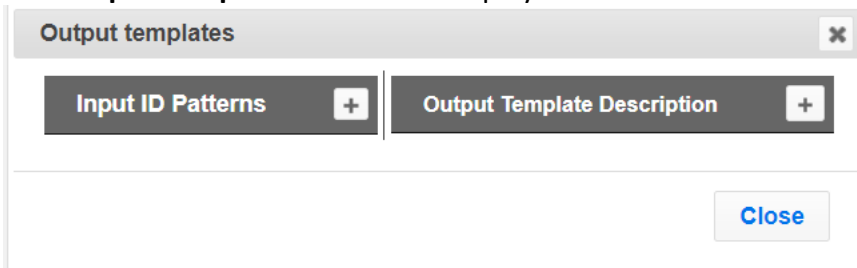

3. Under **Input ID Parameters**, click the '+' button.

The **New Output Pattern Template** window is displayed:

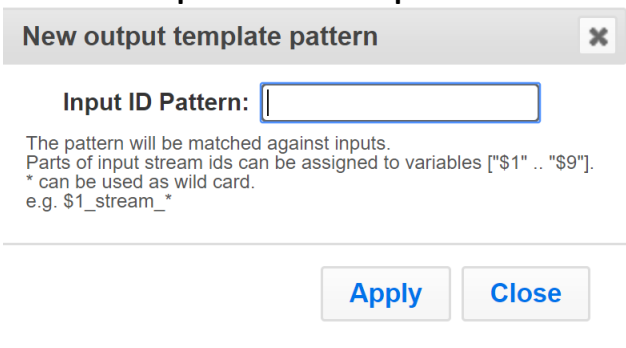

4. In the **Input ID Pattern** field, enter a pattern for the Stream ID of the input stream for which an output will be automatically created. This pattern will be used to identify the input stream and can include variables that are marked with the "\$" sign followed by a number (e.g. \$1, \$2, etc.) and/or with an asterisk "*" wildcard.

The patterns should also include a part of the string that requires an exact match.

For example, the pattern "\$1_stream_\$2kbps" will match an input stream "talk_show_stream_600kbps".

5. Click **Apply**.

The newly created input ID pattern is added to the **Input ID Patterns** list.

6. From the **Input ID Patterns** list, select a pattern for which you want to relate an output template.

7. In the **Output Template Description** section click the "+" button.

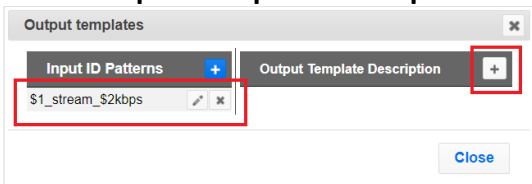

Broadcaster Outputs

Using Output Templates

The **New Output Template** window is displayed:

New output template

Input ID Pattern:
The pattern will be matched against inputs.
Parts of input stream ids can be assigned to variables ["\$1" .. "\$9"].
* can be used as wild card.
e.g. \$1_stream_*

Output Name:

Show in Matrix:

UDP RTMP Pull Push TCP HTTP Push AWS RIST

Output parameters

Host:

Port: TTL:

Smoothing [ms]:

RTP:

Bind to IP:

Local port:

ReMuxing

Enable decryption

Enable IFB/Talkback

Ok Cancel

8. In the **Output Name** field, enter a name for the output that will be created. The name can include variables used in the **Input Pattern** field. For example, the pattern "*\$1_ouput_stream_\$_2kps*" will eventually create an output "*talk_show_output_stream_600kbps*", as it uses the variables that were defined in the **Input Pattern** field.
9. Select the desired output type and fill-in the relevant Output parameters according to the instructions of the relevant section:
 - **UDP Output** – Follow the instructions in the [Adding UDP Outputs](#) section.
 - **RTMP Output** – Follow the instruction in the [Adding RTMP and RTMPS Outputs](#) section.
 - **Pull Output** - Follow the instruction in the [Adding Pull Outputs](#) section.
 - **Push Output** - Follow the instruction in the [Adding Push Outputs](#) section.
 - **TCP Output** - Follow the instruction in the [Adding TCP Outputs](#) section.
 - **HTTP Push** - Follow the instructions in the [Adding HTTP Push Outputs](#) section.
Note that the **Target URL** field can also use the same variables used in the **Input Pattern** field. For example, "[https://s3.amazon.com/zixi/\\$1_folder_\\$_2kbps](https://s3.amazon.com/zixi/$1_folder_$_2kbps)".

Broadcaster Outputs

Using Output Templates

- **AWS Output** - Follow the instructions in the [Adding AWS Outputs](#) section. Note that the **URL** field can also use the same variables used in the **Input Pattern** field. For example, "[https://s3.amazonaws.com/zixi/\\$1_folder_\\$2kpbs](https://s3.amazonaws.com/zixi/$1_folder_$2kpbs)".
- **RIST Output** – Follow the instruction in the [Adding SRT Outputs](#)

The SRT output can be pulled to/from an SRT-enabled device. SRT stands for ‘Secure Reliable Transport’ and is an open-source video transport protocol and technology stack. SRT uses secure streams and easy firewall traversal to optimize streaming performance and deliver high-quality video over even the most unreliable networks.

To Create an SRT Output:

In the Zixi Broadcaster Outputs page click [+ New Output](#). The **New Output** window is displayed.

➔ **Type in the unique identifier for this output in the Output Name.**

9. Select an Input Stream **to** be made available on this **output from** the adjacent drop-down list.
10. Select the Show in Matrix check box to display this **stream in** the Matrix (see [Using the Matrix](#)). Default: Selected.
11. Select SRT.

The screenshot shows the 'New output' dialog box. It includes the following elements:

- Output Name:** A text input field.
- Input Stream:** A dropdown menu.
- Show in Matrix:** A checkbox.
- Output Type Selection:** Radio buttons for UDP, RTMP, Pull, Push, TCP, HTTP Push, AWS, SRT (selected), SRT Client, and RIST.
- Output parameters section:**
 - Listening Port:** A text input field.
 - Password[10-80]:** A text input field.
 - Latency[ms]:** A text input field containing '1000'.
 - Encryption type:** A dropdown menu with 'None' selected.
 - Bind to IP:** A dropdown menu with 'Any' selected.
- Billing Codes:** A checkbox.
- Enable decryption:** A checkbox.
- Buttons:** 'Ok' and 'Cancel' buttons at the bottom right.

12. Enter the Output Parameters (see Output Stream Parameters Table).
13. If you want to specify **Billing Codes** to identify and differentiate traffic on a Zixi Broadcaster for billing purposes, select this checkbox (see Output Stream Parameters Table below)
14. Click OK.
15. **The new** SRT Output with its settings is created and now appears on [the screen](#).
- 16.
17. Output Stream Parameters Table

Parameter	Description
-----------	-------------

Broadcaster Outputs

Using Output Templates

Output Parameters	
Listening Port	Specify the port to listen on. This port must be open on all firewalls between the Zixi Broadcaster and other devices it is communicating with.
Password	If the stream is password protected, enter the password.
Latency	Specify the maximum latency of the stream in milliseconds. Default: 1000
Encryption Type	Specify the type of Encryption (AES 128/192/256).
Bind to IP	Select from the drop-down list the local IP address to be used for this output, OR select <i>Any</i> to enable any IP to be used.
Billing Codes	Billing codes are used to identify and differentiate traffic on a Zixi Broadcaster for billing purposes. When a billing code is added to a Source or Target, Zixi can track the traffic on that Broadcaster input or output separately from other inputs and outputs on the same Broadcaster. Billing codes are created by Zixi personnel on the Zixi Customer Portal for a particular organization.
Billing Code	Enter the billing code that corresponds to this stream. The relevant billing can be obtained from the organization that received the billing code from Zixi.
Billing password	Enter the password that corresponds to this billing code.
Enable Decryption	Select this checkbox to decrypt an encrypted stream.
Decryption type	<p>If the stream has been encrypted, you can decrypt through the output by selecting this checkbox and specifying the type of encryption that was used.</p> <p>Select Automatic to decrypt a stream that has been encrypted using Automatic encryption.</p> <p>Only if the stream has not been encrypted, select None (default).</p> <p>Important Notice: if the stream has been encrypted you must decrypt it in the output.</p>
Decryption key	If the decryption type includes a key, enter the key to decrypt the stream during output.

Adding SRT Client Outputs

The SRT Client output can be pushed to an SRT-enabled device. SRT stands for ‘Secure Reliable Transport’ and is an open-source video transport protocol and technology stack. SRT uses secure streams and easy firewall traversal to optimize streaming performance and deliver high-quality video over even the most unreliable networks.

To Create an SRT Client Output:

Broadcaster Outputs

Using Output Templates

In the Zixi Broadcaster **Outputs** page click . The **New Output** window is displayed.

➔ **Type in the unique identifier for this output in the Output Name.**

9. Select an Input Stream **to** be made available on this **output** from the adjacent drop-down list.
10. Select the Show in Matrix check box to display this **stream** in the Matrix (see [Using the Matrix](#)). Default: Selected.
11. Select **SRT Client**.

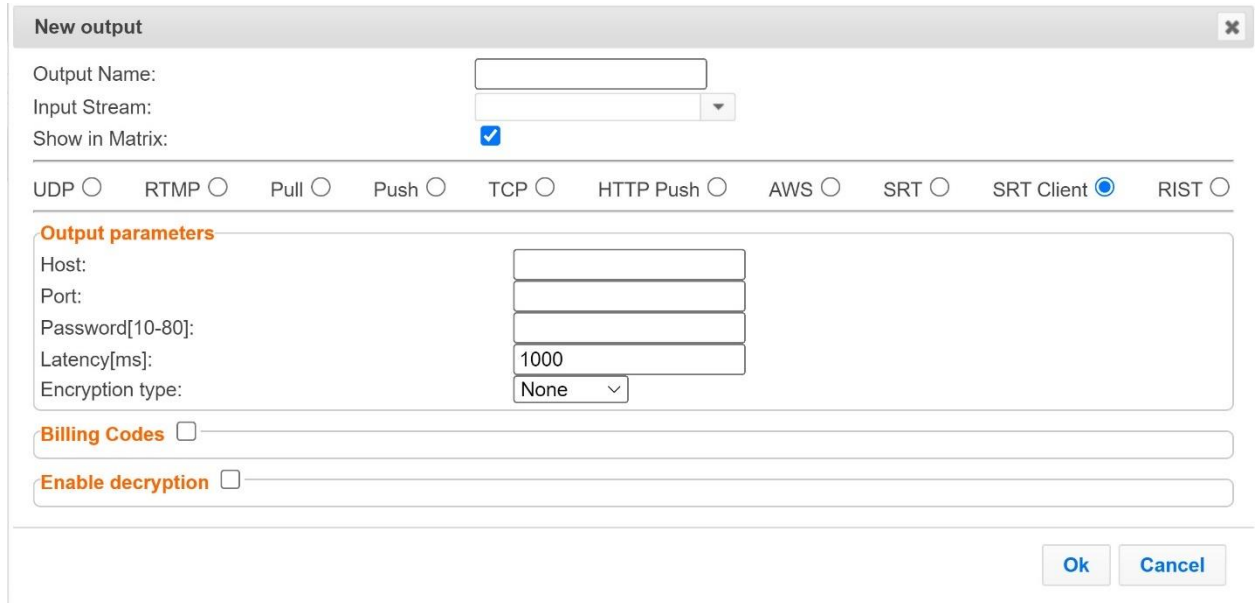

12. Enter the Output Parameters (see Output Stream Parameters Table).
13. If you want to specify **Billing Codes** to identify and differentiate traffic on a Zixi Broadcaster for billing purposes, select this checkbox (see Output Stream Parameters Table below)
14. Click OK.
15. **The new** SRT Client Output with its settings is created and now appears [on the screen](#).
- 16.
17. Output Stream Parameters Table

Parameter	Description
-----------	-------------

Output Parameters

Host	The destination host for the SRT stream.
-------------	--

Port	Specify the ports to which the stream will be pushed.
-------------	---

Password	If the stream is password protected, enter the password.
-----------------	--

Latency	Specify the maximum latency of the stream in milliseconds. Default: 1000
----------------	--

Broadcaster Outputs

Using Output Templates

Encryption Type	Specify the maximum expected bitrate for memory allocation. Recommended: 2X the actual bitrate, which will prevent buffer overruns (especially with VBR streams). Default: 8000. Note – Overflows will typically occur when the Max Bitrate isn't sufficient.
Billing Codes	Billing codes are used to identify and differentiate traffic on a Zixi Broadcaster for billing purposes. When a billing code is added to a Source or Target, Zixi can track the traffic on that Broadcaster input or output separately from other inputs and outputs on the same Broadcaster. Billing codes are created by Zixi personnel on the Zixi Customer Portal for a particular organization.
Billing Code	Enter the billing code that corresponds to this stream. The relevant billing can be obtained from the organization that received the billing code from Zixi.
Billing password	Enter the password that corresponds to this billing code.
Enable Decryption	Select this checkbox to decrypt an encrypted stream.
Decryption type	If the stream has been encrypted, you can decrypt through the output by selecting this checkbox and specifying the type of encryption that was used. Select Automatic to decrypt a stream that has been encrypted using Automatic encryption. Only if the stream has not been encrypted, select None (default). Important Notice: if the stream has been encrypted you must decrypt it in the output.
Decryption key	If the decryption type includes a key, enter the key to decrypt the stream during output.

- Adding RIST Outputs section.

10. Click **OK**.

The template is added to the **Output Template Description** list. When an input pattern will match the pattern of an incoming input stream, the defined output will be created automatically.

Broadcaster Network Bonding

Zixi's Network Bonding feature enables you to divide a stream into several network channels by utilizing multiple NICs and links and then subsequently reuniting them at the Zixi Broadcaster side. For example, a 5 Mbps stream can be streamed using two links, one 2 Mbps link that uses a mobile network and another 3 Mbps Wifi network. The stream is automatically bonded at the Zixi Broadcaster side without any special configuration (as long as the Push input is defined and the two NICs are setup in the machine running the Zixi Broadcaster). Network Bonding can be used for load balancing between multiple links in the following configurations:

- **Zixi Feeder with Multiple NICs to a single Zixi Broadcaster NIC** - the stream is divided at the Zixi Feeder end and then bonded at the Zixi Broadcaster end. This configuration requires configuring Network Bonding in the Zixi Feeder.
- **Zixi Feeder with Multiple NICs to multiple Zixi Broadcaster NICs** - the stream is divided at the Zixi Feeder end, sent to multiple IP addresses (each Zixi Broadcaster NIC has a separate IP address), and then bonded at the Zixi Broadcaster end. This configuration requires configuring Network Bonding in the Zixi Feeder. Each destination (i.e. each Broadcaster NIC is configured in a separate network bonding link by using a different Host IP address).
- **Zixi Feeder with single NIC to Multiple Zixi Broadcaster NICs** - the stream is sent to multiple IP addresses (each Zixi Broadcaster NIC has a separate IP address), and then bonded at the Zixi Broadcaster end. This configuration requires configuring Network Bonding in the Zixi Feeder. Each destination (i.e. each Broadcaster NIC is configured in a separate network bonding link by using a different Host IP address).
- **Zixi Broadcaster with multiple NICs to another Zixi Broadcaster with a single/multiple NICs** - a Zixi Broadcaster can transfer a stream to another Zixi Broadcaster through multiple NICs at the source Broadcaster and single/multiple NICs at the destination Broadcaster. This configuration requires configuring Network Bonding in the Zixi Broadcaster (see Broadcaster Output with Network Bonding).

Using Network Bonding for Hitless Failover

The Network Bonding feature can be used to ensure high availability of the stream. The feature ensures hit-less failover between multiple networks and network cards (i.e. network and hardware protection). As part of the configuration of the network bonding feature it is possible to set a NIC (which may be connected to a separate network) as a "Backup". In this case, the backup link will only be utilized if the stream has used all other available capacity. For example, a stream can be configured to be transferred on a WiFi network as the main link and a mobile network as a backup. If the WiFi link is compromised (either completely unavailable or limited bandwidth), the stream will be transferred, in full or partially through the backup mobile link and then bonded at the Zixi Broadcaster end, enabling uninterrupted streaming and high availability.

Broadcaster Outputs

Broadcaster Network Bonding

Broadcaster Output with Network Bonding

A Zixi Broadcaster can push a stream to another Zixi Broadcaster that has been divided into multiple network channels by utilizing multiple NICs. The Zixi Broadcaster at the destination will subsequently reuniting them into a single input stream.

➔ To add network bonding to a Push Output:

1. Create a **Push Output**, by following the instructions in the [Adding Push Outputs](#) section.
2. In the **Output Parameters** section, select the **Bond Links** checkbox.

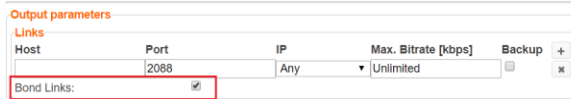

The screenshot shows the 'Output parameters' dialog box. Under the 'Links' section, there is a table with columns: Host, Port, IP, Max. Bitrate [kbps], and Backup. The first row has values: Host (empty), Port (2088), IP (Any), Max. Bitrate (Unlimited), and Backup (unchecked). Below the table, the 'Bond Links' checkbox is checked and highlighted with a red box.

3. In the **Links** section, click the **+** button to add a second link:

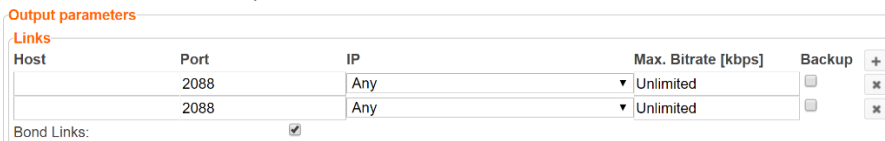

The screenshot shows the 'Output parameters' dialog box with two links added. The table has two rows: the first row has Host (empty), Port (2088), IP (Any), Max. Bitrate (Unlimited), and Backup (unchecked); the second row has Host (empty), Port (2088), IP (Any), Max. Bitrate (Unlimited), and Backup (unchecked). The 'Bond Links' checkbox is checked.

4. In the **Host** field, type the IP address of the destination Zixi Broadcaster.
5. In the **Port** field, type the destination port number of the Zixi Broadcaster to which you want to stream. Default: 2088
6. In the **IP** field, select the NIC in the Zixi Broadcaster (source) that you want to use to stream.
7. In the **Max. Bitrate** field, do one of the following:
 - If you want to limit the bitrate that will be used in this link, enter the maximum bitrate value in Kbps.
 - If you DO NOT want to limit the bitrate, leave the default value - "Unlimited".
8. In the **Backup** field, do one of the following:
 - If you want to use this link only if there is not enough bandwidth in the other links, select the Backup checkbox.
 - If you want to use this link in parallel to other links, DO NOT select the Backup checkbox.
9. Configure additional parameters as required.
10. Click **OK** to save the Zixi Broadcaster Output.

Adaptive Groups

Zixi Broadcaster features the ability to create multiple bitrate profiles for a single input stream and set it as an adaptive group that can be used by a supporting client. The client will automatically switch between the various bitrate profiles of the stream according to the network conditions during playback.

After creating a group with different bitrates you can test them all out by playing them with the different 3rd party players (via the  Actions menu).

You can optionally create adaptive group templates that will automatically group streams in adaptive groups instead of defining groups in advance.

Creating New Adaptive Groups

➔ To Create a New Adaptive Group:

1. In the Zixi Broadcaster administrative screen, click the **Adaptive** tab.
2. Click **Add Group**.

The **Adaptive live streams group** window is displayed:

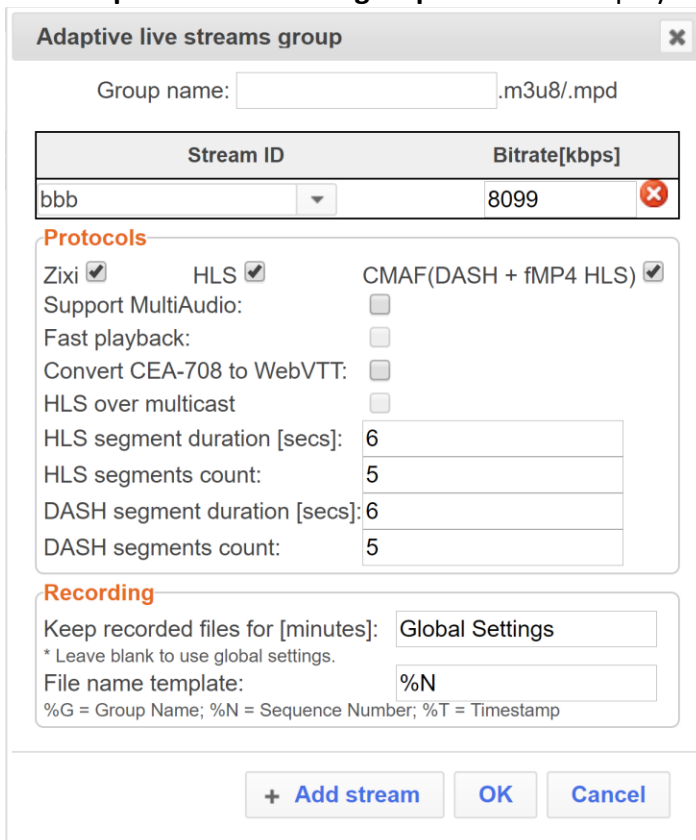

Stream ID	Bitrate[kbps]
bbb	8099

Protocols

Zixi HLS CMAF(DASH + fMP4 HLS)

Support MultiAudio:

Fast playback:

Convert CEA-708 to WebVTT:

HLS over multicast

HLS segment duration [secs]:

HLS segments count:

DASH segment duration [secs]:

DASH segments count:

Recording

Keep recorded files for [minutes]:

* Leave blank to use global settings.

File name template:

%G = Group Name; %N = Sequence Number; %T = Timestamp

+ Add stream OK Cancel

3. In the **Group Name** field, enter the unique string as the adaptive group's name.

Adaptive Groups

Creating New Adaptive Groups

- Under **StreamID**, select an input stream from the drop-down list to create an adaptive bitrate.
- Enter the desired **Bitrate[kbps]** for that stream in the adjacent field to **Stream ID**.
- Click to add as many streams as you want to include in the group and repeat steps 4 and 5 for every stream that is added to the group.
- Select one or more **Protocols** that will be supported for this adaptive group. The Zixi protocol option enables devices using the Zixi SDK to view the stream using the Zixi protocol.
- Select **Support MultiAudio** if the input streams include multiple audio channels to enable multiple separate audio channels in the adaptive group.
- Specify the HLS/Dash segment/chunk duration and count (See details in the table below).
- Specify the duration to **Keep recorded files for [minutes]**. If the file is left as blank, the system will use the global settings, specified in the **Settings > Live Protocols** screen in the **HLS DVR Maximum Recording Duration** field.
- In the **File name template** field, specify the file name pattern that Zixi will use to generate when saving the recorded content.
- Click **OK**.

The new Adaptive Group is created and appears on the Adaptive screen.

Parameter	Description
Group Name	Specify the unique identifier for this group.
Stream ID	Select an input stream from the drop-down list.
Bitrate [kbps]	Specify the bitrate for the selected stream.
Protocols	Select one or more Protocols that will be supported for this adaptive group - Zixi HLS (enables devices using the Zixi SDK to view the stream using the Zixi protocol), HLS, CMAF(DASH + fMP4 HLS)
Support MultiAudio	Select this checkbox to enable multiple separate audio channels in the adaptive group.
Fast playback	Select this setting to enable low latency HLS delivery. The Enable HLS Fast playback on the Settings > Live Protocols screen must be enabled. Only the TS segments version of the HLS stream will be available for adaptive streaming, not the fragmented MP4 (fMP4) version. When enabled, the following playback URLs will be available: <ul style="list-style-type: none">http://<server url>:7777/playback.m3u8?stream=<adaptive group name>http://<server url>:7777/<adaptive group name>.m3u8
Convert CEA-708 to	Extracts closed caption from video elementary stream and converts it to WebVTT format.

Adaptive Groups

Creating New Adaptive Groups

WebVTT	This feature is currently available for HLS only and there is no support to styling/placement, just text.
---------------	---

HLS Over Multicast	Select this checkbox to enable multicasting of the adaptive stream (requires multicast to be enabled in the Settings).
---------------------------	--

HLS Segment Duration [sec]	Specify the duration in seconds of each segment/chunk in the HLS playlist. You can specify sub-second durations (e.g. 0.5). (Default: 6 seconds)
-----------------------------------	--

HLS Segments Count	Specify the number of segments in the HLS playlist.
---------------------------	---

DASH Segment Duration [sec]	Specify the duration in seconds of each segment/chunk in the DASH adaptive group. You can specify sub-second durations (e.g. 0.5). (Default: 6 seconds)
------------------------------------	---

DASH Segments Count	Specify the number of segments in the DASH adaptive group.
----------------------------	--

Recording



Keep recorded files for [minutes]	Specify the maximum time for storing the recording. If the file is left as blank, the system will use the global settings specified in the Settings > Live Protocols screen in the HLS DVR Maximum Recording Duration field.
--	---

File name template	<p>Specify the file name pattern that Zixi will use to generate when saving the recorded content. A separate file will be generated for each recording up to the time specified in the Max recorded file duration parameter (see above). After this duration a new file will be generated.</p> <p>The file name pattern can include any string and up to three variables listed below. Only the %T=HH.MM.SS Timestamp is mandatory. You can change the order of these variables and add text as long as you maintain the legitimate structure of the file in Linux and Windows:</p> <ul style="list-style-type: none">%G = Group Name – optional%N = Sequence Number – optional%T=HH.MM.SS Timestamp - mandatory
---------------------------	--

Adding Streams to Existing Adaptive Groups

You can add additional streams to existing adaptive groups.

➔ To Add Streams to an Adaptive Group:

1. In the Zixi Broadcaster administrative screen, click the **Adaptive** tab.
2. Select the Group to which you want to add a stream, and click  button, and then **Edit**. The **Adaptive live streams group** window is displayed.
3. Click  button for as many streams as you want to include in the group. Another Stream row will be added in the above table to which a desired **Bitrate** must be specified. When clicking on the red  at the end of any of the stream rows, the stream will be deleted from the group.
4. Click **OK**. The group has been modified accordingly.

Adaptive Groups Templates

Instead of defining adaptive groups in advance and then relating specific input streams to these groups, you can define templates with rules for automatic grouping of streams in adaptive groups. Every time a new input stream, which matches the conditions of the template, is added, it will be automatically added to the adaptive group that was defined in the template. Specific streams are identified by naming patterns and added to the group by setting static naming patterns and bitrates or dynamic patterns.

➔ To create a new adaptive group template:

1. Click the **Adaptive** tab at the top of the Zixi Broadcaster administrative screen.
2. In the Menu bar, click the **Templates** () button.
The Adaptive Groups Templates screen is displayed:

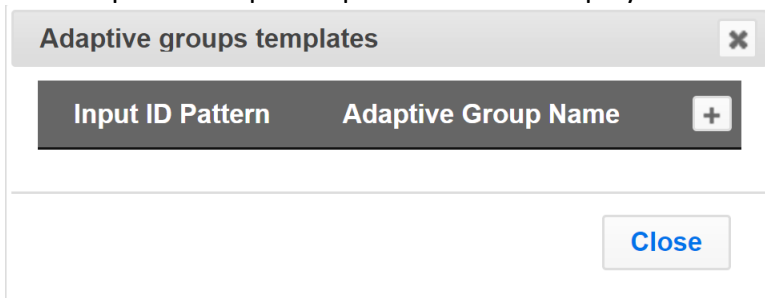

Adaptive Groups

Adaptive Groups Templates

3. Click the + button.

The **Adaptive Group Template** window is displayed:

The screenshot shows a dialog box titled "Adaptive group template" with a close button (X) in the top right corner. Below the title bar, there is a small text block: "Input ID Pattern will be matched against inputs. Parts of input stream ids can be assigned to variables ['\$1' .. '\$9']. * can be used as wild card. e.g. \$1_stream_profile_*". Below this is an "Input ID Pattern:" label followed by an empty text input field. A horizontal line separates this from the next section, "Adaptive Group Name:", which has an empty text input field. Below this is another text block: "Variables from Input ID pattern can be used to form adaptive group name. e.g. \$1_adaptive_stream". The next section is "Adaptive group properties" and contains several checkboxes: "Zixi" (checked), "HLS" (checked), "DASH" (unchecked), "HLS over multicast" (unchecked), and "Record" (unchecked). Below these is a "Keep recorded files for [minutes]:" label followed by an empty text input field, with a note below it: "* Leave blank to use global settings." Below that is a "File name template:" label followed by an input field containing "%N". A legend below the field states: "%G = Group Name; %N = Sequence Number; %T = Timestamp". The next section is "Adaptive group stream patterns" with a note: "Streams expected in adaptive group may connect later." Below this are two radio buttons: "Dynamic streams acquisition" (unchecked) and "Static streams set" (checked). At the bottom of this section is a "Stream pattern" label and a "Bitrate [kbps]" label followed by a "+" button. At the very bottom of the dialog are "Apply" and "Close" buttons.

4. In the **Input ID Pattern** field, enter a pattern for the Stream ID of the input stream that will be automatically added to newly created adaptive group. This pattern will be used to identify the input stream and can include variables that are marked with the "\$" sign followed by a number (e.g. \$1, \$2, etc.) and/or with an asterisk "*" wildcard. The patterns should also include a part of the string that requires an exact match. For example, the pattern "\$1_stream_\$2kbps" will match an input stream "talk_show_stream_600kbps". String parts that were matched against \$X variables, can be reused in other settings, however, string parts that were matched against an asterisk wildcard cannot be reused in other settings.
5. In the **Adaptive Group Name** field, enter a string that will be used as the name of the adaptive group. You can use the \$X variables that were used in the Input ID Pattern field above. For example, based on the above example, if you write "\$1_group", the group name will be "talk_show_group".
6. Under the **Adaptive Group Properties**, select the checkboxes of the protocols with which these streams will be transmitted (Zixi, HLS, DASH, HLS over multicast).
7. If you want to record an HLS stream, select the **Record** checkbox and in the **Keep recorded files for [minutes]**, specify the maximum time (in minutes) to record. Default:

Adaptive Groups

Adaptive Groups Templates

the time defined in the global settings, specified in the **Settings > Live Protocols** screen in the **HLS DVR Maximum Recording Duration** field.

- Under **Adaptive Group Stream Patterns**, select the method in which the streams in the adaptive group will be created:
 - Dynamic Streams Acquisition:** this method will automatically add input streams that match the defined **Input ID Pattern** and give them a bitrate value based on the **Bitrate Pattern**. This option is based on the assumption that the bitrate value is part of the input stream's ID. Based on the example above, by entering the value "\$2" in the **Bitrate Pattern** field, the system will automatically add the incoming "talk_show_stream_600kbps" stream, while giving it a 600 Kbps Bitrate setting (according to the definition in the **Input ID Pattern** field, the \$2 was assigned a value of 600kps). If another stream that matches the input ID patters comes in (e.g. talk_show_stream_700kbps") with a different bitrate, for example, 700kbps, this stream will be also added to the same adaptive groups, however the bitrate setting will be 700 kbps.

Adaptive group stream patterns

Streams expected in adaptive group may connect later.

Dynamic streams acquisition Static streams set

Any stream matching 'Input ID Pattern' will be added.

Bitrate pattern:

To add a Dynamic Streams Acquisition bitrate pattern:

- In the **Bitrate Pattern** field add the pattern as described above.
- Click **Apply**.

The new template is added to the **Adaptive Groups Templates** list:

Adaptive groups templates

Input ID Pattern	Adaptive Group Name	
\$1_stream_\$2kbps	\$1_adaptive_stream	<input type="text"/> <input type="text"/>

Close

- Static Stream Set:** if the input streams do not have the bitrate value in their ID names, you can manually define the ID and the bitrate for each stream that will be included in the group. You can define streams that are not currently connected, but will be connected at a later stage.

Adaptive Groups

Performing Actions on Adaptive Groups

Adaptive group stream patterns
Streams expected in adaptive group may connect later.

Dynamic streams acquisition Static streams set

Stream pattern	Bitrate [kbps]	
<input type="text" value="comedy_HD"/>	<input type="text" value="512"/>	<input type="button" value="+"/>
		<input type="button" value="x"/>

To add a Static Steam Set:

1. Click the + button
2. In the **Stream Pattern** field, enter a pattern for the stream ID (you can use the variables used in the Input ID Pattern field and add additional variables as needed). This pattern will be used to identify the stream and add it to the group (e.g. "comedy_HD").
3. In the **Bitrate [Kbps]** field, enter the Bitrate value of the stream.
4. Click the + button for as many streams as you want to include in the group and repeat the steps above for every stream that is added to the group.
5. Click **Apply** to save all changes.

The new template is added to the **Adaptive Groups Templates** list:

Adaptive groups templates		
Input ID Pattern	Adaptive Group Name	
\$1_stream_\$2kbps	\$1_adaptive_stream	<input type="button" value="+"/>
		<input type="button" value="edit"/> <input type="button" value="x"/>



the group will be active only when all the streams defined will be connected.

Performing Actions on Adaptive Groups

Every adaptive group has a shortcut button that can be used to perform relevant actions.

Stopping/Starting an Adaptive Group

You can start or stop the stream(s) in the adaptive group at any time.

Adaptive Groups

Performing Actions on Adaptive Groups

➔ To Stop/Start the Adaptive Group:

1. In the Zixi Broadcaster **Adaptive Groups** page, click the adaptive group row that you want to start/stop.
2. Click the  button on the right end of the selected row and then **Start/Stop**. The status will change to Connected/Stopped accordingly.

Editing an Existing Adaptive Group

➔ To Edit the Configuration of an Adaptive Group:

1. In the Zixi Broadcaster **Adaptive Groups** page, click the adaptive group row that you want to edit.
2. Click the  button on the right end of the selected row and then **Edit**. The Adaptive live stream group screen is displayed. You can modify any of the settings.
3. Click **OK**. The new settings will take effect.

Deleting and Adaptive Group

➔ To delete an Adaptive Group:

1. In the Zixi Broadcaster **Adaptive Groups** page, click the adaptive group row that you want to delete.
2. Select the Group to which you want to add a stream, and click  button, and then **Delete**. The message "**Are you sure you want to delete group <group_name>?**" is displayed.

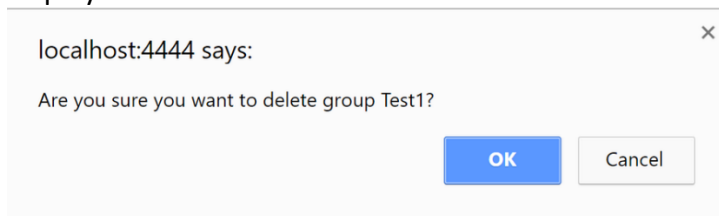

3. Click **OK**. The selected row adaptive group will be deleted.

Play Dash

Zixi Broadcaster can generate links to play the Adaptive Group stream in MPEG DASH format. To enable Dash, make sure DASH is select when creating the Adaptive Group.

➔ To Play MPEG DASH:

1. In the Zixi Broadcaster **Adaptive Groups** page, click the adaptive group row that you want to playback.

Adaptive Groups

Performing Actions on Adaptive Groups

2. Select the Group to which you want to add a stream, and click  button, and then click **Play Dash**.

The following window is displayed:

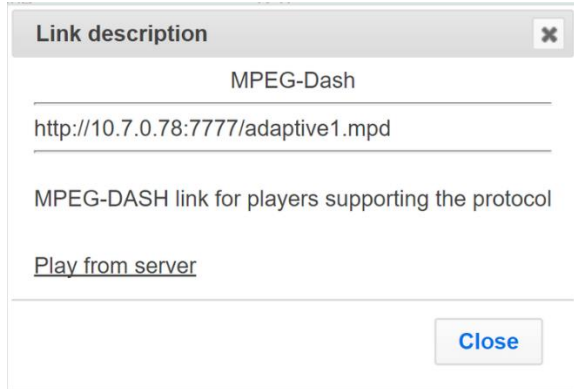

3. Do one of the following:
 - If you have a locally installed MPEG DASH compatible player - click the link to stream the data to your player.
 - If you DO NOT have a player - click **Play from server**. The stream will open in a web-based player.
4. Click **Close** when finished.

Play fMP4

Zixi Broadcaster can generate links to play the Adaptive Group stream in fMP4 HLS format.

➔ To Play fMP4 HLS:

1. In the Zixi Broadcaster **Adaptive Groups** page, click the adaptive group row that you want to playback.
2. Select the Group to which you want to add a stream, and click  button, and then click **Play fMP4**.

The following window is displayed:

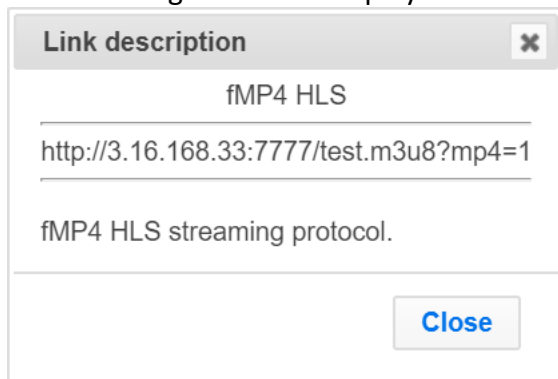

Adaptive Groups

Performing Actions on Adaptive Groups

3. Copy the link that is generated at the bottom of the window and paste it into a player/browser for playback.
4. Click **Close** when finished.

Play HLS

Zixi Broadcaster can generate links to play the Adaptive Group stream in HLS format over HTTP, UDP, or Multicast (requires Multicast enabled).

➔ To Play HLS:

1. In the Zixi Broadcaster **Adaptive Groups** page, click the adaptive group row that you want to playback.
2. Select the Group to which you want to add a stream, and click  button, and then click **Play HLS**.

The following window is displayed:

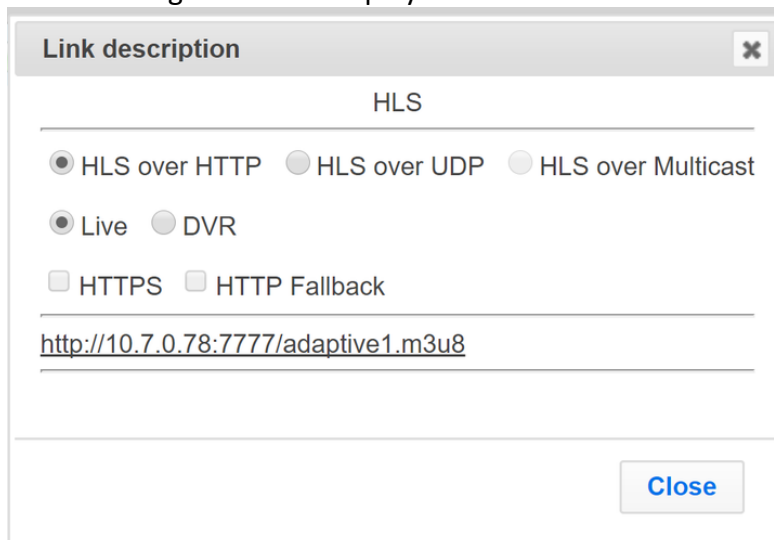

The screenshot shows a dialog box titled "Link description" with a close button (X) in the top right corner. The dialog is titled "HLS" and contains the following options:

- HLS over HTTP HLS over UDP HLS over Multicast
- Live DVR
- HTTPS HTTP Fallback

Below the options is a text field containing the URL: <http://10.7.0.78:7777/adaptive1.m3u8>. At the bottom right of the dialog is a "Close" button.

3. Do one of the following:
 - **HLS over HTTP** - streams the adaptive stream over HTTP. Select **Live** to stream a live stream or select **DVR** to select a recorded stream. To stream from an encrypted HTTPS link, select the **HTTPS** checkbox. To stream from a secondary/backup server, select the **HTTP Fallback** checkbox.
 - **HLS over UDP** - streams the adaptive stream over UDP. Select **Live** to stream a live stream or select **DVR** to select a recorded stream. To stream from an encrypted HTTPS link, select the **HTTPS** checkbox. To stream from a secondary/backup server, select the **HTTP Fallback** checkbox.
 - **HLS over Multicast** - streams the adaptive stream over UDP. Select **Live** to stream a live stream or select **DVR** to select a recorded stream. To stream from

Adaptive Groups

Performing Actions on Adaptive Groups

- an encrypted HTTPS link, select the **HTTPS** checkbox. To stream from a secondary/backup server, select the **HTTP Fallback** checkbox.
4. Copy the link that is generated at the bottom of the window and paste it into a player/browser for playback.
 5. Click **Close** when finished.

Set Preroll

A preroll transport stream file is a video/audio file that is played before the adaptive group video is played. Before setting the preroll, you should make sure that the file is available for VOD and that VOD is enabled in the File Transfer and VOD settings.

➔ To set a Pre-roll:

1. Upload the Pre-roll TS File to the designated Root folder on the Zixi Broadcaster server. To find your Root folder location, go to Settings > General. The Root path is specified in the Root Folder field.

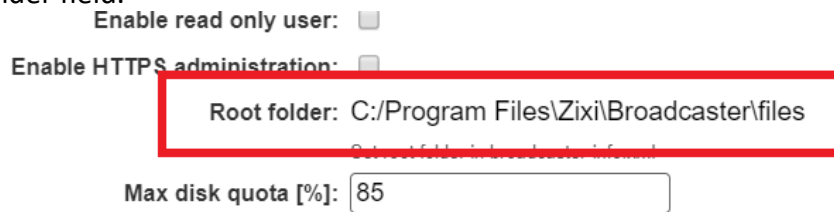

2. In the **Settings > File Transfer & VOD** screen, select the **VOD** checkbox. The following window is displayed:



3. In the Zixi Broadcaster Adaptive Groups screen, click the desired adaptive group for which you want to add the preroll.

Adaptive Groups

Performing Actions on Adaptive Groups

4. Click the  button on the selected row and then click **Set Preroll**. The following window is displayed:

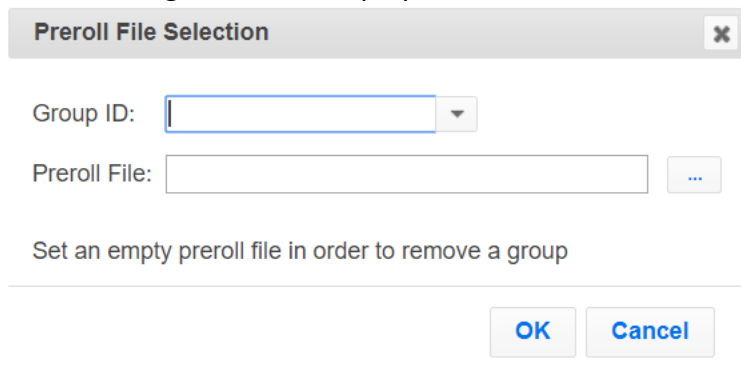

The dialog box titled "Preroll File Selection" contains the following elements:

- A "Group ID" field with a dropdown arrow.
- A "Preroll File" field with a "Browse" button (three dots).
- A note: "Set an empty preroll file in order to remove a group".
- "OK" and "Cancel" buttons at the bottom.

5. In the **Group ID** field, select the adaptive group for which you want to add the preroll.
6. In the **Preroll File** field, click the **Browse** button and select the desired file.
7. Click **OK**.

VOD (Video on Demand)

The VOD feature enables you to upload stream-able (.ts and mp4) files to the file system of the server on which Broadcaster is installed as well as make a previously recorded input stream available on demand (VOD). The VOD content is accessed through a local folder, where the Zixi Broadcaster is located. This local folder can be optionally mapped through a symbolic link or shortcut to a remote folder. The Broadcaster creates a unique URL for each file.

The streams can be played back using VLC (with Zixi Plugin for Zixi streams) and/or streamed to a Zixi Receiver or to a Zixi Broadcaster. During playback, an Output (with output type – **Download**) will be created automatically on the Source Zixi Broadcaster, as shown below.

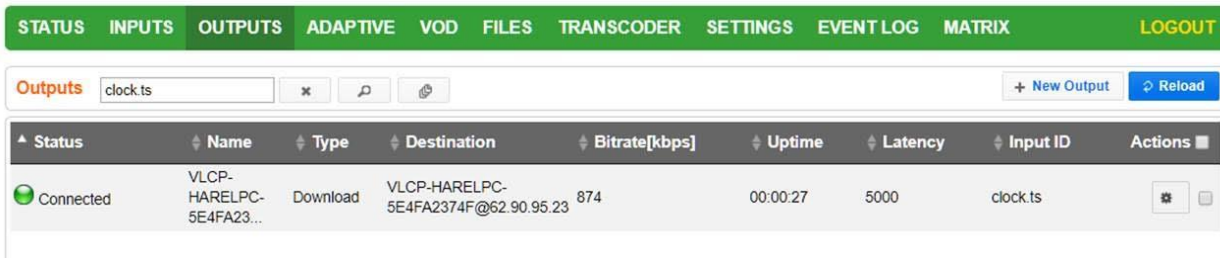

Status	Name	Type	Destination	Bitrate[kbps]	Uptime	Latency	Input ID	Actions
Connected	VLCP-HARELPC-5E4FA23...	Download	VLCP-HARELPC-5E4FA2374F@62.90.95.23	874	00:00:27	5000	clock.ts	[Settings] [Close]

VOD Activation

If you have a VOD-enabled license you will still need to activate the VOD feature in the **Settings** screen.

➔ To activate the VOD feature:

1. In the **Settings** page, click **File Transfer & VOD**.
2. Select the **VOD** checkbox.

HLS Indexing:

MPEG-DASH Indexing:

VOD:

Encrypt downloads:

Max download speed [kbps]: ~100.0 Mbit/s

3. Click **Apply**.

VOD Files Location

The VOD files are located in the following location by default -

<Broadcaster_Installation_Folder>\Zixi\Broadcaster\files

VOD (Video on Demand)

VOD Files Location

The contents of this folder are displayed in the **VOD** screen on the Zixi Broadcaster GUI –

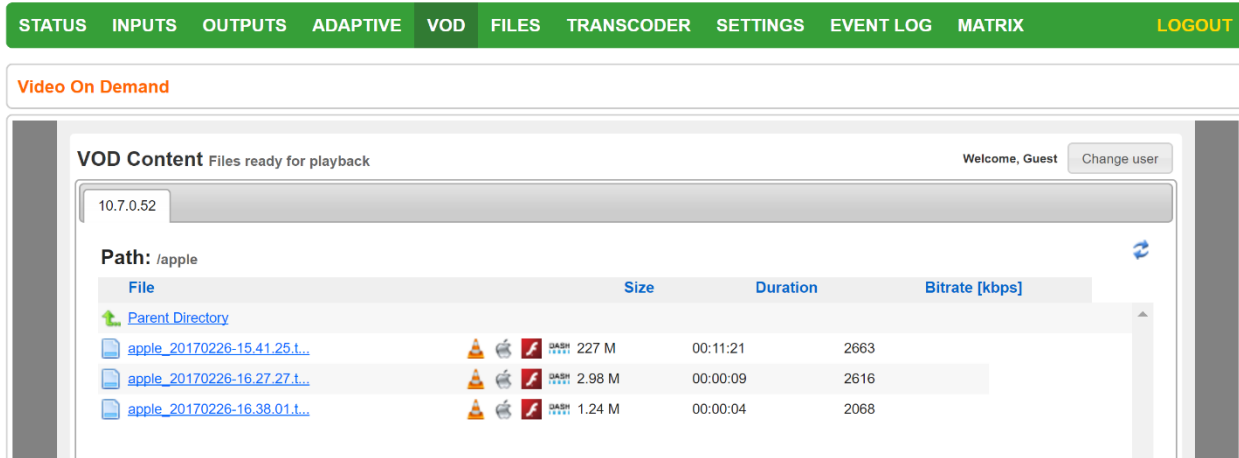



The VOD screen displays the following information:

Parameter Description

File	Name of the file or folder. If in file level (not folder level), click the file name to preview the stream in the Matrix screen.
-------------	--

The following icons are displayed:

 - **VLC Playback** – click this icon to see the VLC playback URL and additional details, such as VLC plugin download link, and link to stream the file.

 - **HLS Playback** – click this icon to see the following three HLS playback URLs: local HLS playback (not Zixi protected), HLS playback using Zixi Proxy (Zixi Protected), HLS playback using Zixi Proxy through HTTPS (Zixi protected). The Zixi Proxy links require the installation of Zixi Proxy software in the receiving device/machine. The dialog includes links for downloading the Zixi Proxy for Windows and Mac.

<Icons>

 - **HDS Playback** – click this icon to see the Adobe HTTP Dynamic Streaming Protocol playback URL. The Play from server link, plays back the stream directly from the server.

 - **Flash Playback** – click this icon to see the following three Flash playback URLs: local Flash playback (not Zixi protected), Flash playback using Zixi Proxy (Zixi Protected), Flash playback using Zixi Proxy through HTTPS (Zixi protected). The Zixi Proxy links require the installation of Zixi Proxy software in the receiving device/machine. The dialog includes links for downloading the Zixi Proxy for Windows and Mac.

 - **Dash Playback** - click this icon to see the MPEG-DASH playback URL. The Play from server link, plays back the stream directly from the server.

Size	The size of the file.
-------------	-----------------------

Duration	The duration of the playback.
-----------------	-------------------------------

Bitrate	The bitrate of the file in Kbps.
----------------	----------------------------------

VOD (Video on Demand)

Adding Files to VOD

[kbps]

Changing the Files folder location

➔ To change the Files folder location:

1. In the Zixi Broadcaster installation folder
(`<Broadcaster_Installation_Folder>\Zixi\Broadcaster\`) open the following file: **broadcaster-info.xml**.

2. Edit the `<Folder>` parameter with the desired path.

```
<?xml version="1.0" encoding="utf-8"?>
<ROOT_SETTINGS>
  <FOLDER>C:\Program Files\Zixi\Broadcaster\files</FOLDER>
  <MANAGED>>false</MANAGED>
  <MANAGEMENT-ENABLED>>false</MANAGEMENT-ENABLED>
</ROOT_SETTINGS>
<TUNNEL>
  <ALLOW>>false</ALLOW>
  <MANAGED>>false</MANAGED>
  <MANAGEMENT-ENABLED>>false</MANAGEMENT-ENABLED>
</TUNNEL>
```

3. Save the file.

Adding Files to VOD



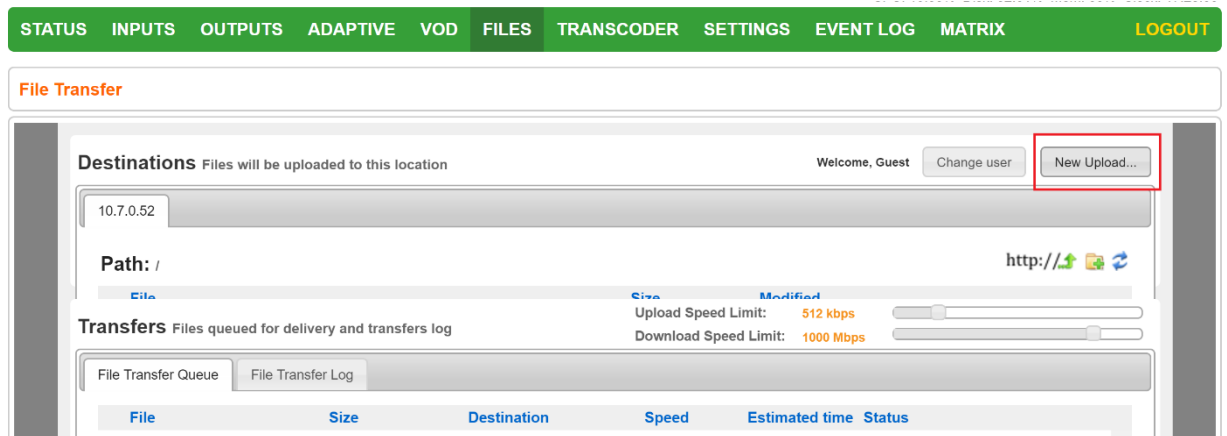

There are two ways to add files into the VOD Files folder:

- **Adding files to the folder** – using the operating system on which Zixi Broadcaster is installed, add the desired files to the Files folder
(`<Broadcaster_Installation_Folder>\Zixi\Broadcaster\Files`)
- **Uploading using the Broadcaster GUI** – on the **Files** screen, click the **New Upload** button, browse to the desired file location, select the file and click **Upload**.



Playing back VOD content

The VOD content can be played back using VLC (with Zixi Plugin for Zixi streams) and/or streamed to a Zixi Receiver or to a Zixi Broadcaster by using the following methods:

- **URL (Static)** – entering a specific URL of a file. To find the URL of a specific file, go to the VOD screen, navigate to the specific file, and click on the relevant playback icon:
 -  - **VLC Playback** – click this icon to see the VLC playback URL and additional details, such as VLC plugin download link, and link to stream the file.
 -  - **HLS Playback** – click this icon to see the following three HLS playback URLs: local HLS playback (not Zixi protected), HLS playback using Zixi Proxy (Zixi Protected), HLS playback using Zixi Proxy through HTTPS (Zixi protected). The Zixi Proxy links require the installation of Zixi Proxy software in the receiving device/machine. The dialog includes links for downloading the Zixi Proxy for Windows and Mac.
 -  - **HDS Playback** – click this icon to see the Adobe HTTP Dynamic Streaming Protocol playback URL. The Play from server link, plays back the stream directly from the server.
 -  - **Flash Playback** – click this icon to see the following three Flash playback URLs: local Flash playback (not Zixi protected), Flash playback using Zixi Proxy (Zixi Protected), Flash playback using Zixi Proxy through HTTPS (Zixi protected). The Zixi Proxy links require the installation of Zixi Proxy software in the receiving device/machine. The dialog includes links for downloading the Zixi Proxy for Windows and Mac.
 -  - **Dash Playback** - click this icon to see the MPEG-DASH playback URL. The Play from server link, plays back the stream directly from the server.
- **API (Dynamic)** – you can use the Zixi API to implement dynamic access to the VOD content. For example, you can create an application that enables navigation throughout the VOD library (including folders and sub-folders) to access files in a dynamic fashion. The API GET request is: <http://<broadcaster location><web server port>/vod ls.json>

Indexing VOD content

Zixi Broadcaster can create m3u8 (HLS) and mpd (mpeg-dash) manifests for VOD files. When the **Automatically index VOD files** setting is enabled, Zixi Broadcaster will index the VOD files in the various VOD folders. In this case, Zixi Broadcaster will automatically monitor any file and directory structure changes (under "files" folder only). Any file that is added will be automatically indexed. In the same manner, any file that is deleted, the correspondent files in the index (.m3u8 and/or /mpd) will be removed as well. In some cases, the indexing of VOD

VOD (Video on Demand)

Indexing VOD content

files can affect performance. By enabling or disabling the **Automatically index VOD files** setting, you can decide when to index the VOD files in order to ensure optimal performance during peak times.

➔ To activate the VOD indexing:

1. In the **Settings** page, click **File Transfer & VOD**.
2. Select the **Automatically index VOD files** checkbox.

Automatically index VOD files:

Scan on startup:

HLS Indexing:

MPEG-DASH Indexing:

VOD:

3. Select **Scan on startup** to enable indexing of the files in the VOD folder that have not been indexed during startup of the Zixi Broadcaster.
4. Select **HLS indexing** to enable indexing of HLS streams. The indexing creates an M3U8 playlist file.
5. Select **MPEG-DASH indexing** to enable indexing of MPEG-DASH streams. The indexing creates a .mpd (MPEG-DASH Media Presentation Description) file.
6. Click **Apply**.

Accelerated File Transfer

Zixi Broadcaster features the ability to transfer files between two Zixi components (Zixi Broadcaster to Zixi Receiver or to another Zixi Broadcaster), using the Zixi protocol. The transfer can also be to a non-Zixi component with a Zixi Proxy or with a Zixi Plugin. This enables the reliable and fast transfer of large files over a wireless/wifi connections.

File Transfer Configuration

Before using the file transfer feature, you will need to activate the file transfer feature and configure the following file transfer settings.

➔ **To activate and configure the file transfer feature:**

1. In the **Settings** page, click **File Transfer & VOD**.

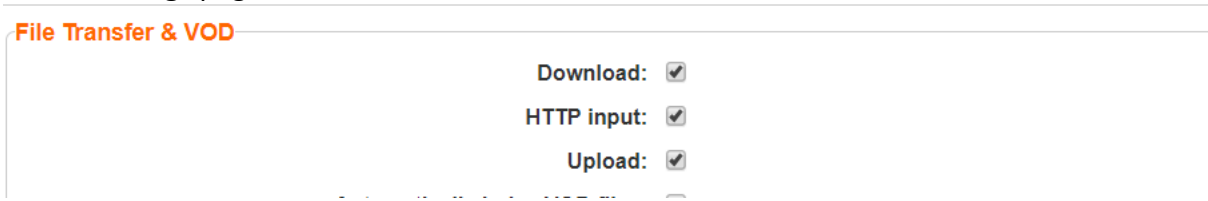

2. Select the **Download** checkbox to enable the download of files from the current Zixi Broadcaster.
3. Select **HTTP Input** checkbox to enable HTTP forwarding.
4. Select the **Upload** checkbox to enable the uploading of files by registered users to the current Zixi Broadcaster.
5. Specify additional optional **file transfer setting parameters** (see File Transfer Setting table below).
6. Click **Apply**.

File Transfer Settings

Parameter	Description
Download	Enables the file transfer download from this Zixi Broadcaster.
HTTP Input	Enables HTTP acceleration mode. In this mode, instead of specifying a file location on the server's hard disk, the Zixi Broadcaster receives an HTTP address from which it will retrieve the file and then transfer it to the Client.
Upload	Enables the file transfer upload to this Zixi Broadcaster server.
Encrypt Downloads	Enables the Zixi auto encryption for all file transfer downloads.

Accelerated File Transfer

Uploading Files for File Transfer

Max download speed [kbps] Specifies the maximal download speed in Kbps for file transfer.

Max upload speed [kbps] Specifies the maximal upload speed in Kbps for file transfer.

Initial bitrate [kbps] Specifies the initial download bitrate. The recommended bitrate can be the bitrate of the stream.

HTTP/Origin cache size [MB] This setting is relevant for HTTP acceleration mode and/or Origin/Edge architecture, where the Zixi Broadcaster retrieves the file from another Origin or HTTP server and then delivers it to the Client. This setting determines the cache size allocation on the Zixi Broadcaster. The cache is used to accelerate the delivery of files that have been previously requested.

Uploading Files for File Transfer

You can upload files to the server on which Zixi Broadcaster is installed to make them available for download using Zixi protocol. The location of the files that will be uploaded is relative to the Root folder that was specified in the **Settings > General** screen.



Before you upload a file, make sure Zixi Proxy is installed on your computer. If it is not installed, you will be prompted with a notification and a link for download and installation.

➔ To upload a file for file transfer:

1. In Zixi Broadcaster, click the **Files** tab.
2. Click **New Upload**.

The **Select Files to Upload** dialog opens:

Accelerated File Transfer

Uploading Files for File Transfer

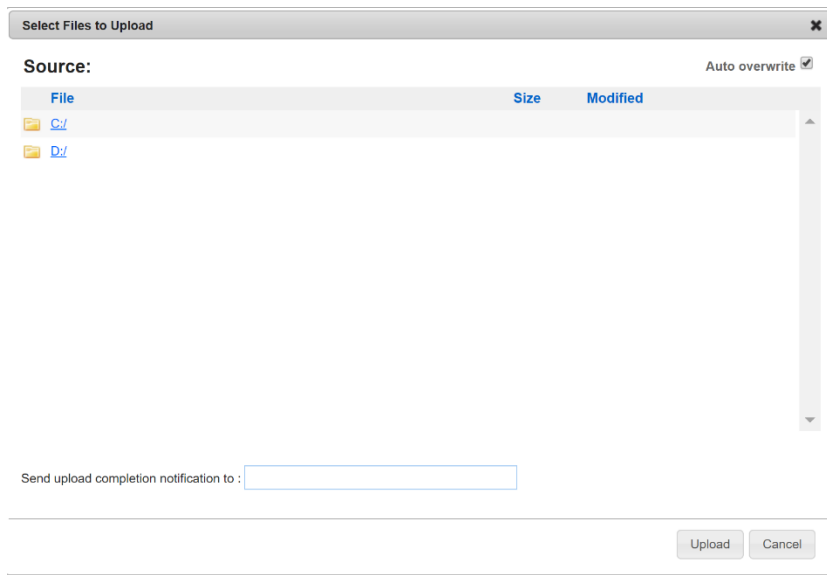



3. Navigate to the path in which the file is located and select the file.
4. For very large files, it is possible to receive an email notification when the upload process was completed. To enable this feature, type the desired email address, or multiple email addresses separated by commas in the **Send upload completion notification to** field.
5. Click **Upload**.

The file will be uploaded using the Zixi protocol. The upload process is displayed at the bottom of the screen (**Files Transfer Queue** tab). When the upload is complete, it will be recorded in the **File Transfer Log** tab.



You can limit the upload speed by dragging the **Upload Speed Limit** slider.

Upload Speed Limit:	512 kbps	
Download Speed Limit:	1000 Mbps	

The overall maximal limit determined by the **Max upload speed [kbps]** setting in the **Settings > File Transfer & VOD** screen.

Downloading Files

Files can be downloaded using the Zixi Protocol or HTTP Protocol through the Zixi Broadcaster UI.

Downloading Files using Zixi Protocol

➔ To download a file using Zixi Protocol:

1. In Zixi Broadcaster, click the **Files** tab.
2. Under **Destinations**, navigate to the desired file.
3. Hover your mouse over the desired file and click **Zixi Download**.

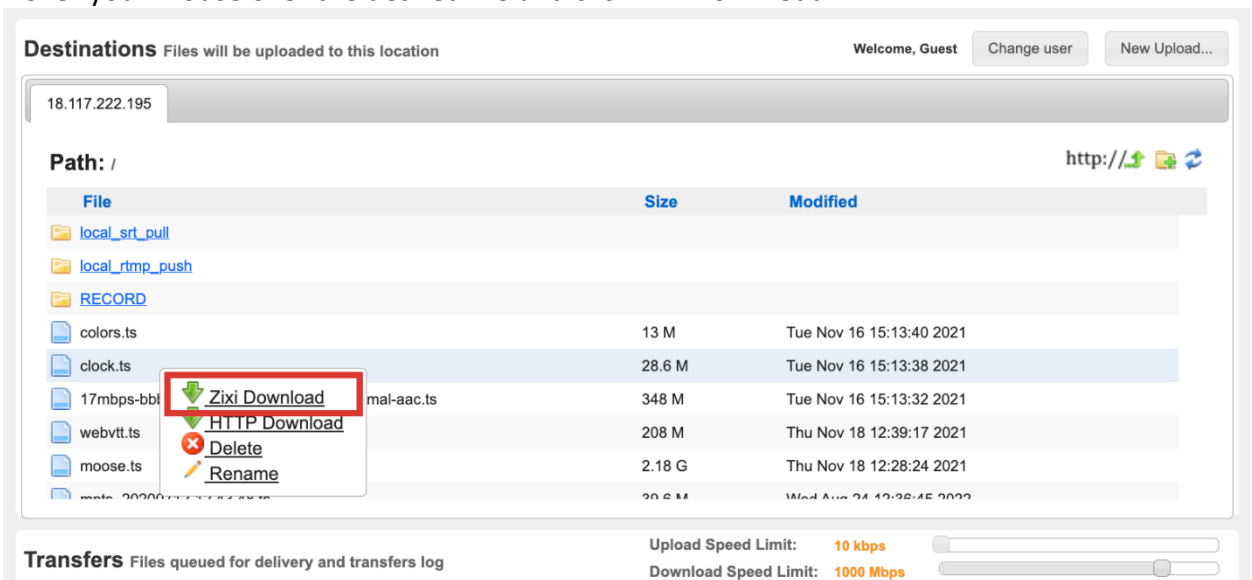

4. In the **Select Download Destination** window, select the local folder as a destination for the file download.

The file will be downloaded using the Zixi protocol. The download process is displayed at the bottom of the screen (**Files Transfer Queue** tab). When the download is complete, it will be recorded in the **File Transfer Log** tab.

 You can limit the download speed by dragging the **Download Speed Limit** slider.

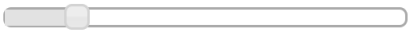
Upload Speed Limit: 512 kbps 

Download Speed Limit: 1000 Mbps 

The overall maximal limit determined by the **Max download speed [kbps]** setting in the **Settings > File Transfer & VOD** screen.

Accelerated File Transfer

Generating Accelerated URLs

Downloading Files using HTTP Protocol

➔ To download a file using HTTP Protocol:

1. In Zixi Broadcaster, click the **Files** tab.
2. Under **Destinations**, navigate to the desired file.
3. Hover your mouse over the desired file and click **HTTP Download**.

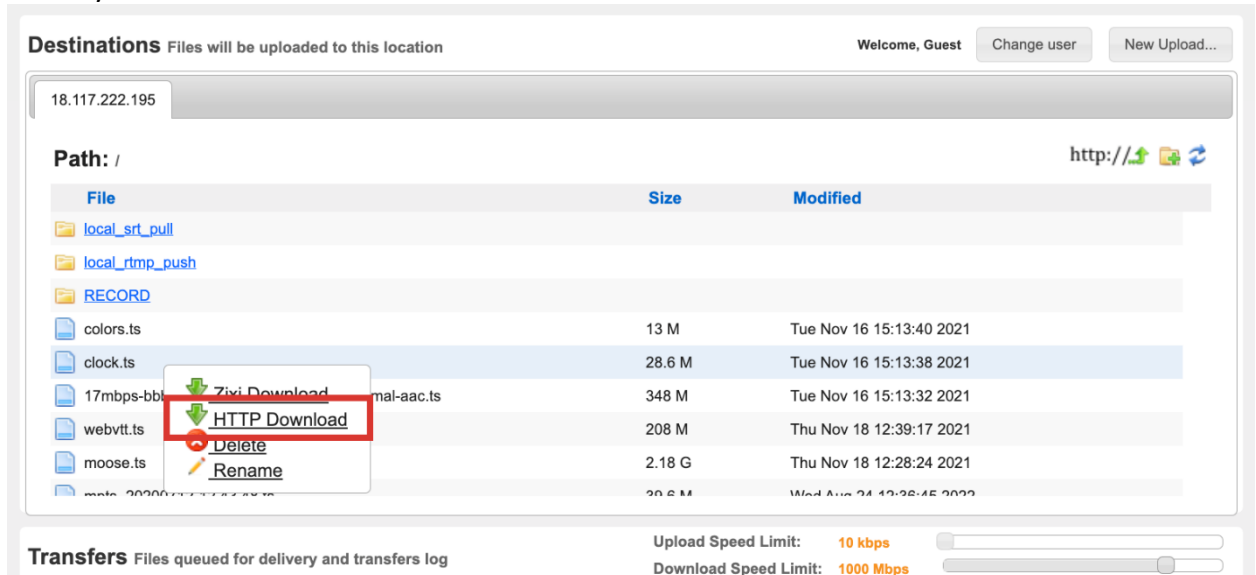

The file will be downloaded using HTTP protocol.

Generating Accelerated URLs

Instead of downloading files from the server on which Zixi Broadcaster is installed, it is possible to use Zixi Broadcaster to retrieve the file from a remote HTTP server. Zixi Broadcaster converts the remote server URL to an Accelerated URL. By using this accelerated URL to download the file, Zixi Broadcaster will retrieve the file from the remote server and use the Zixi Protocol to transfer the file to the Client.

➔ To generate an accelerated URL:

1. In Zixi Broadcaster, click the **Files** tab.

Accelerated File Transfer

Creating a New Folder

2. Under **Destinations**, click the  icon.

The following window appears:

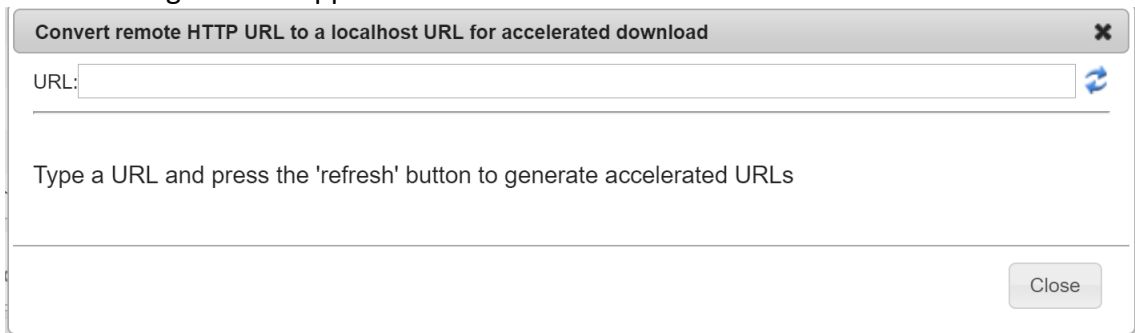

3. In the **URL** field, type the URL of file in the remote HTTP server.
4. Click the  icon.

Two URLs are generated:



The top URL is an HTTP URL and the bottom is an HTTPS URL.

Creating a New Folder

You can use the Zixi Broadcaster UI to create folders on the server on which Zixi Broadcaster is installed.

➔ To create a new folder:

1. In Zixi Broadcaster, click the **Files** tab.
2. Under **Destinations**, click the  icon.

The following window appears:

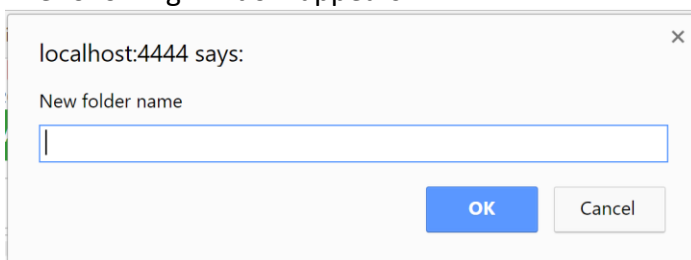

Accelerated File Transfer

Renaming a File/Folder

3. In the **New folder name** field, type a name for the folder.
The folder is created.

Renaming a File/Folder

You can rename a folder or a file through the Zixi Broadcaster UI.

➔ To rename a folder/file:

1. In Zixi Broadcaster, click the **Files** tab.
Under **Destinations**, navigate to the desired file.
2. Hover your mouse over the desired file and click **Rename**.

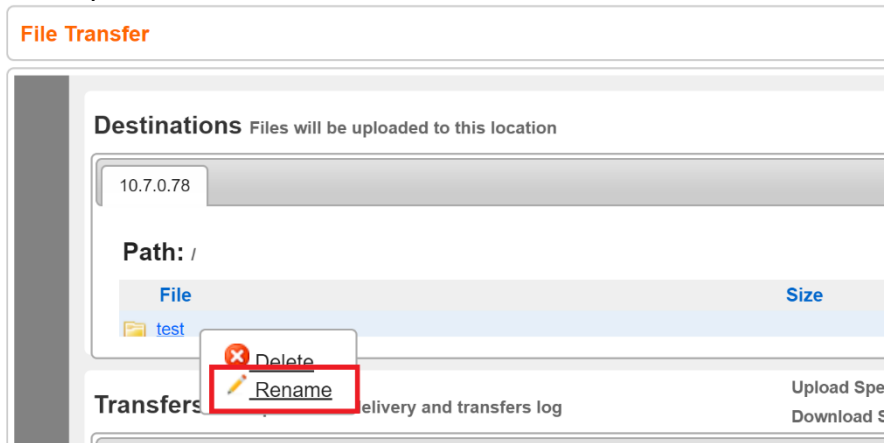

3. In the field, enter the new folder/file name. The location of the files/folder is relative to the Root folder that was specified in the **Settings > General** screen.

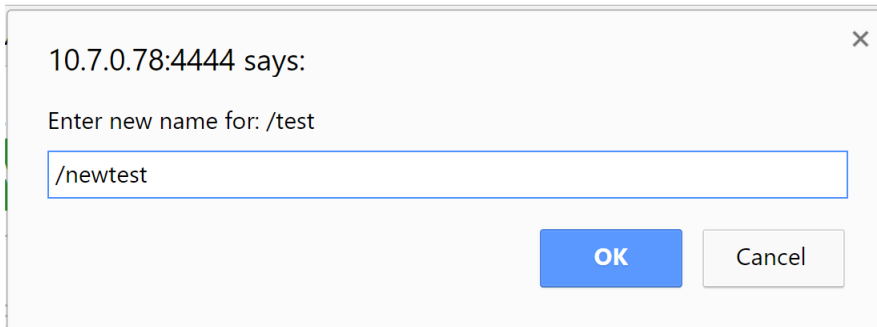

4. Click **OK**.

Deleting an Existing File/Folder

You can delete a folder or a file through the Zixi Broadcaster UI.

Accelerated File Transfer

Deleting an Existing File/Folder

➔ To delete a folder/file:

1. In Zixi Broadcaster, click the **Files** tab.
- Under **Destinations**, navigate to the desired file.
5. Hover your mouse over the desired file and click **Delete**.

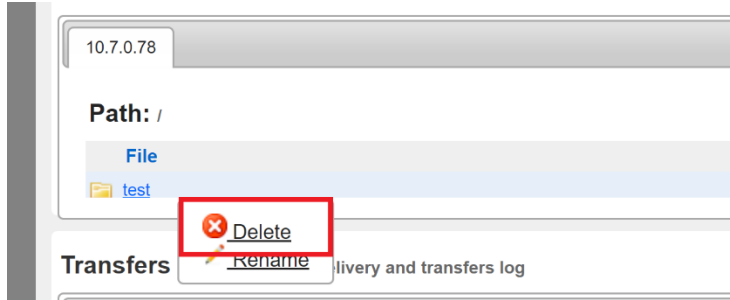

The following dialog is displayed:

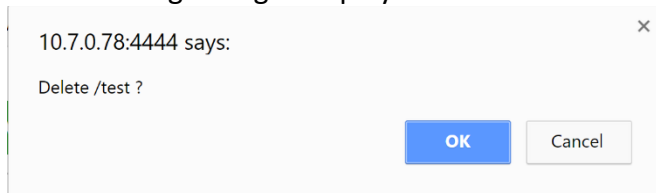

6. Click **OK**.

Transcoder

Zixi Broadcaster offers live transcoding, enabling users to create multiple bitrate streams from a single input stream. The transcoding converts the video and audio live streams to a variety of profiles and bitrates. SCTE-35 markers will be preserved by the transcoder.

The transcoder is typically employed in the following cases:

- Where a target device does not support the source format.
- Where a target has limited storage capacity that requires a reduced file size.
- To convert incompatible obsolete data to a better-supported or modern format.
- You can add video (H.264, H.265, MPEG2, Raw) and audio (AAC, OPUS, Raw) profiles.



Transcoding is not currently supported in ARM builds of Zixi Broadcaster.

Transcoding Templates

Instead of manually selecting input streams to be transcoded, you can optionally define templates with rules for automatic transcoding of input streams according to the settings of a pre-defined Transcoding Template.

NDI Transcoding

For details about NDI transcoding, see [Configuring NDI Streams](#) section.

WebRTC Transcoding

For details about WebRTC transcoding, see section [Configuring WebRTC Streams](#).

Creating New Profiles

In order for the Broadcaster to switch from one encoding to another, different transcoding profiles must be configured first. These transcoding profiles include the transcoding settings that can be used for the transcoding of streams.

Supported Video and Audio formats include:

- Video Decoding – MPEG2, H.264/AVC, H.265/HEVC, Raw
- Video Encoding – MPEG2, H.264/AVC, H.265/HEVC, Raw
- Audio Decoding – AAC, MPEG-1 Audio Layer I / II / III, MPEG-2 Audio Layer I / II / III, AC-3 (Dolby Digital), Opus



For AC-3, which can contain up to six discrete channels of sound, the transcoder only supports the left and right channels and will ignore the other channels.

- Audio Encoding – AAC, AAC-HE (High Efficiency) and AAC-HEv2; Pass-through (no encoding) – any audio codec (MPEG1/2 / AAC / AC-3, E-AC-3 (Dolby Digital Plus), Opus.

Transcoder

Creating New Profiles



AAC-HE and AAC-HEv2 are only supported for Zixi Broadcasters, v13 and up.

The transcoder comes with the following pre-set common video profiles:

1080i60 / 1080i59.94, 1080p30 / 1080p25, 720p60, 720p50 / 720p30, 576i60 / 576p25, 480i60 / 480p29.97

You can also define your own custom profiles.



For downstream satellite workflows, you will probably need to generate constant bitrate (CBR) streams. This setting is configured at the individual input level (not the transcoding profile level). To set a CBR, enter the desired Transport Stream Bitrate (Kbps) as described in the **Transcoding an Input Stream** section.

Transcoder

Creating New Profiles

➔ To Create a New Profile:

1. In the **Transcoder** page, click .

The **Add New Profile** window is displayed:

Add New Profile

Codec type

H.265 H.264 Raw Video AAC Opus Raw Audio

Profile configuration

Preset: Custom

Name:

Encoder: x264

Encoding Profile: Baseline

Resolution: X

Keep Source Aspect Ratio

Frames per Second: Original

Bitrate Mode: VBR

Average Bitrate (kbps):

Max Bitrate (kbps):

Performance: Very Fast

Advanced options

Copy GOP from source:

GOP [frames]: 60

Closed: Fixed:

B-Frames: 0

Frame Type: Progressive

Reference Frames: 2

HRD buffer length (seconds): 1

CRF: 23

Max QP: 0

Chroma Subsampling: As Source

2. Select the desired **Codec type** - MPEG2, H.264 or H.265, or Raw Video for a video profile or select AAC, Opus, or Raw Audio for an audio profile.
3. Enter the desired fields in the **Profile configuration** (see table below for additional parameters). Select a specific **Preset** profile to automatically fill in the default settings for that profile, OR select **Custom** to create a new profile from scratch.



You can edit specific fields of a preset configuration while creating the profile.

Transcoder

Creating New Profiles

4. If you want to configure the **Advanced options** for the video profiles, select **Advanced options** and fill in the respective fields (see table below for additional parameters).
5. Click **Apply**.

The newly configured profile is created and appears on the screen.

Parameter	Description
Profile configuration	For Video - MPEG2, H.264, H.265, Raw Video
Preset	Select one of the pre-configured presets or select Custom to create a new profile from scratch. Even if you select a preset configuration, you can still change its settings. Default: Custom
Name	Enter a unique name for the profile.
Encoder	Select one of the following options: <ul style="list-style-type: none">• X264 – software-based encoder (available for H.264 only).• Intel – Intel-based hardware encoder.• NVIDIA – NVIDIA-based hardware encoder.

Transcoder

Creating New Profiles

Select the relevant encoding profiles:

For H.265 video profiles with hardware acceleration:

- Main (default) – this profile supports 8 Bit Per Pixel encoding (BPP).
- Main 10 – this profile supports 10 Bit Per Pixel encoding (BPP).
- Main SP - The Main Still Picture profile allows for a single still picture to be encoded with the same constraints as the Main profile. As a subset of the Main profile the Main Still Picture profile allows for a bit depth of 8-bits per sample.

For H.264 video profiles:

Encoding Profile

- High - The primary profile for broadcast and disc storage applications, particularly for high-definition television applications.
- Main - This profile is used for standard-definition digital TV broadcasts that use the MPEG-4 format as defined in the DVB standard.
- Baseline - Primarily for low-cost applications that require additional data loss robustness, this profile is used in some video conferencing and mobile applications.

For MPEG2 video profiles:

- High – supports SNR and Spatial Scalability and Intra DC Precision of 8, 9, 10, and 11.
- Main - supports I and P and B Picture Coding Types and Intra DC Precision of 8, 9, 10.
- Simple – supports I and P Picture Coding Types and Intra DC Precision of 8, 9, 10.

Resolution

Enter the new resolution in pixels, if resizing the video.

Keep Source Aspect Ratio

Select this checkbox (default) to maintain the original aspect ratio.

Frames per Second

Select a new frame rate or select **Original** to use the original frame rate of the stream.

Default: Original

Note: When a new frame rate is specified, it is applied using "Smooth frame rate conversion".

Note: When the frame rate is converted, captions in the elementary stream are preserved.

Average Bitrate (kbps)

Specify the average bitrate for the profile.

Max Bitrate (kbps)

Specify the maximum bitrate for the profile. Available only if the Bitrate Mode is set to VBR.

Transcoder

Creating New Profiles

Performance	Select the performance of the transcoding. Possible values range from <i>Ultra Fast</i> which provides the best quality while utilizing high CPU/GPU to <i>Slower</i> which has the lowest quality but uses much less CPU/GPU. Default: <i>Very Fast</i>
Advanced Options	
Copy GOP from source	Select this checkbox if you want to maintain the source GOP length (not structure). Enabling this option will generate an I-frame in the transcoded stream with the exact timestamp as in the source stream. The Copy GOP from source option is only available when selecting the Original option in the Frames per Second field. If you want to change the source GOP length specify the new GOP length in the GOP [Frames] parameter.
GOP [frames]	Specify the number of frames in a GOP (Group of Pictures). Default:60
GOP Settings	<ul style="list-style-type: none">• Closed – for a GOP in which the previous pictures do not need data from the subsequent GOP for bidirectional coding, select the Closed checkbox (default).• Fixed – to always use the specified number of frames in the GOP (as opposed to allowing the encoder to override), select the Fixed checkbox (default).
B-Frames	Specify the maximal number of consecutive B frames in the GOP . Default: 0
Frame Type	Specify the frame type – progressive or interlaced. Default: Progressive
Reference Frames	Specify the number of frames that can be referenced for each frame. Default: 2
HRD buffer length (seconds)	Specify the length of the HRD buffer in MPEG-2.
CRF	The Constant Rate Factor (CRF) is the default quality (and rate control) setting for x264 and x265 encoders. You can set the values between 0 and 51, where lower values would result in better quality, at the expense of higher file sizes. Higher values mean more compression, but at some point you will notice the quality degradation.
MAX QP	The QP (Quantization) parameter controls how the compression rate. Ranging from 0 (No compression) and 51 (Max compression). Max QP - controls the maximum value the encoder can set for QP. For example, a low number will result in a lower compression rate causing the video to look better, however requiring a higher bitrate. A higher max QP value may reduce the visual quality but results in a lower bitrate.

Transcoder

Creating New Profiles

Chroma Subsampling	<p>Converts the source chroma sub sampling (method for "compression" of raw images) to 4:4:4/ 4:2:2 / 4:2:0.</p> <p>As Source – maintains the same chroma subsampling as in the source.</p> <p>4:4:4 is applicable for Nvidia HEVC codec or x264 high profile</p> <p>4:2:2 is not supported on Nvidia GPU</p> <p>4:2:0 is supported on Nvidia and x264.</p>
---------------------------	---

Bit Depth	<p>Conversion of the 10-bit HDR color encoding source to 8 BPP.</p> <p>This feature is enabled for the following configurations:</p> <ul style="list-style-type: none">• H.264 – Encoder: X264; Encoding Profile: High 10.• H.265 – Encoder: Nvidia; Encoding Profile: Main 10. <p>If the source is 10-bit, select one of the following:</p> <ul style="list-style-type: none">• As Source – to maintain a 10-bit color encoding.• 8 BPP – to down convert the source to 8 bit per pixel. if the source is already 8bpp, it does nothing.
------------------	---

Profile configuration	For Audio – AAC, OPUS, Raw Audio.
------------------------------	--

Name	Enter a unique name for the profile.
-------------	--------------------------------------

Bitrate	Specify the bitrate for the profile.
----------------	--------------------------------------

Sampling Rate	<p>You can convert the audio sampling rate from 44.1kHz to 48kHz and vice versa. Select one of the following options:</p> <ul style="list-style-type: none">• Copy from source – if you do not wish to make any changes.• 44.1kHz – to convert a 48kHz audio stream to 44.1kHz.• 48kHz – to convert a 44.1kHz audio stream to 48kHz.
----------------------	--

Encoding Profile (for AAC)	<ul style="list-style-type: none">• AAC-LC (default) - AAC Low Complexity. The simplest and most widely used and supported profile.• HE-AACv1 - AAC High Efficiency 1. This profile uses spectral band replication (SBR) to enhance the compression efficiency in the frequency domain.• HE-AACv2 - AAC High Efficiency 2. couples SBR with Parametric Stereo (PS) to enhance the compression efficiency of stereo signals. It is a standardized and improved version of the eAAC+ codec.
-----------------------------------	---

Transcoding an Input Stream

Once you have created the profile, you can use it to transcode an input stream.

► To Transcode an Input Stream:

1. On the **Inputs** page of Zixi Broadcaster, click the desired row of the input stream that you want to transcode.
2. Click the  button on the right end of the selected row and then **Transcode**. The **Transcode <input stream name>** window with the settings of the selected input stream is displayed.

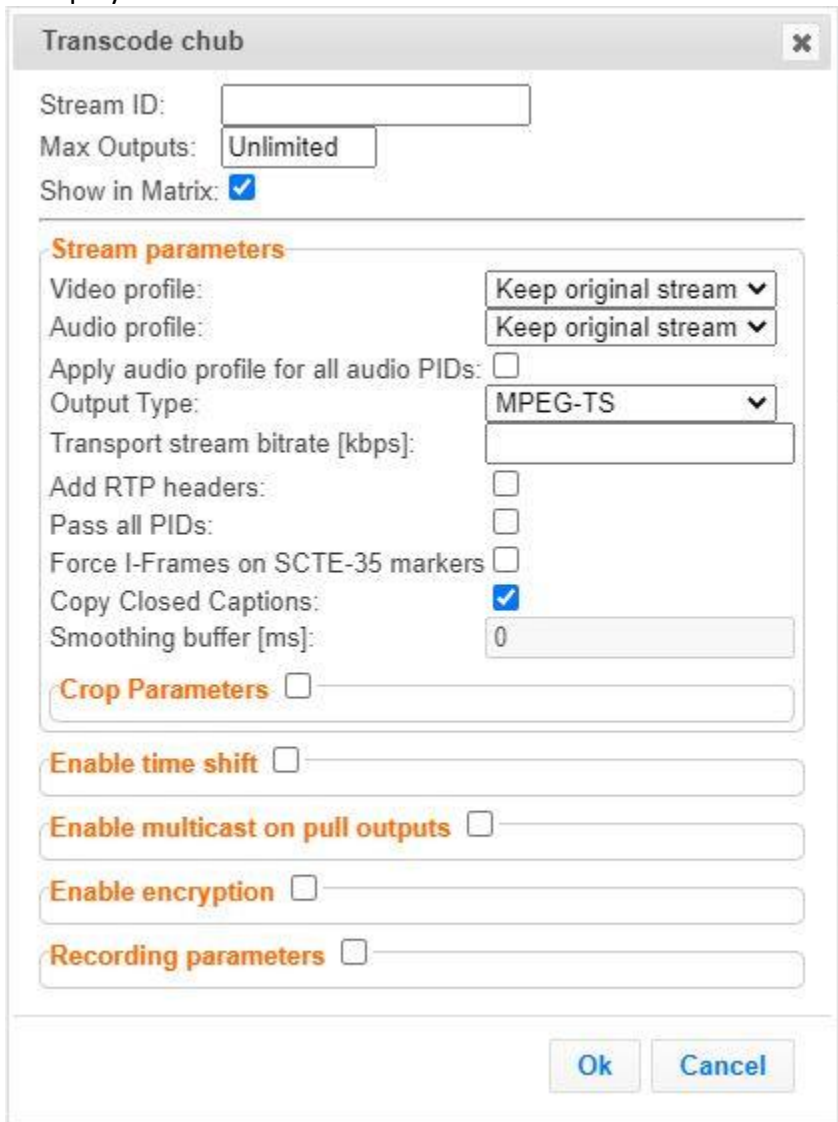

Transcode chub

Stream ID:

Max Outputs:

Show in Matrix:

Stream parameters

Video profile:

Audio profile:

Apply audio profile for all audio PIDs:

Output Type:

Transport stream bitrate [kbps]:

Add RTP headers:

Pass all PIDs:

Force I-Frames on SCTE-35 markers:

Copy Closed Captions:

Smoothing buffer [ms]:

Crop Parameters

Enable time shift

Enable multicast on pull outputs

Enable encryption

Recording parameters

3. Enter the unique **Stream ID** for the new transcoded input stream.

Transcoder

Transcoding an Input Stream

4. Under **Stream Parameters**, in the Video profile and Audio profile fields, do one of the following:
 - Select the desired Video Profile and/or Audio Profile that you have configured.
 - Select **Keep original stream** - if you have not configured a video or audio profile or do not want it transcoded or you want to set specific transcoding parameters for the specific stream. In this case the video or audio input will not be transcoded.
 - Select **Remove stream** – you can use the transcoder to remove the video or audio track from the stream.
5. Fill in additional fields (see table below for additional parameters).
6. Click **OK**.

The transcoded input stream is created and appears in an embedded window labeled **Transcoded sources** under the original input stream from which it was created.

Parameter	Description
Stream Parameters	
Video Profile	Select an existing profile, select Keep original stream if you do not wish to transcode the video stream, or select Remove stream if you want to remove the video track.
Audio Profile	Select an existing profile, select Keep original stream if you do not wish to transcode the audio stream, or select Remove stream if you want to remove the audio track.
Apply audio profile for all audio PIDs	Select this option if you want to re-encode all audio tracks using the same audio profile, instead of just the first audio track that is detected.
Output Type	Select one of the following output types. The outputs are configured as part of the transcoding process, so there is no need to create the Output from the Zixi Broadcaster Outputs screen: <ul style="list-style-type: none">• MPEG-TS – the output will be available as MPEG Transport Stream.• NDI – the output will be available as NDI. When selecting NDI output, you can select the following video/audio profiles:<ul style="list-style-type: none">○ Video profile – remove stream or a Raw profile.○ Audio profile - remove stream or a Raw profile.• WebRTC – the output will be available as WebRTC. When selecting NDI output, you can select the following video/audio profiles:<ul style="list-style-type: none">○ Video profile – remove stream, keep original stream, Raw video profile, or if the input stream is not WebRTC compliant, a transcode to WebRTC compliant profile (e.g. H.264 codec with Baseline or Main profile and no B frames).○ Audio profile - remove stream, keep original stream, Raw audio

Transcoder

Transcoding an Input Stream

Parameter	Description
	profile, or if the input stream is non-Opus, transcode to Opus.
Transport Stream Bitrate (Kbps)	<p>Specify the bitrate of the transport stream. This parameter is optional. If you do not specify a TS Bitrate, the stream will be VBR. If you specify a bitrate, the stream will be CBR.</p> <p>Note – CBR is recommended for downstream satellite workflows.</p>
Add RTP headers	Select this option to add RTP header to the MPEG-TS packets
Use Hardware Acceleration (if available)	Select this checkbox to use hardware acceleration component (e.g. NVIDIA or Intel) if it has been installed.
Pass all PIDs	Select this checkbox to pass-through all non-transcoded PIDs.
Force I-Frames on SCTE-35 markers	<p>Selecting this option will do the following:</p> <ul style="list-style-type: none">• If a SCTE35 marker is detected and it contains a specific video timestamp (PTS), the encoder will generate an IDR-frame on the video frame with the closest or equal timestamp.• If there is no timestamp in the SCTE35 marker, the transcoder will generate an IDR frame as soon as it can.
Copy Closed Captions	If the video source contains closed caption, select this option to copy the CC to the encoded video streams, otherwise it will be dropped. This option is relevant for HEVC and h264 sources and targets.
Smoothing Buffer (ms)	<p>Specify how much of the transcoded stream (in milliseconds) to store before transmitting it back to the server in order to prevent bursts.</p> <p>If the Transport stream bitrate [kbps] field is empty, the smoothing buffer is disabled.</p> <p>If the Transport stream bitrate [kbps] field is NOT empty, it is recommended to enter around 200ms, which should be enough to prevent bursts.</p>
Crop Parameters	Select this checkbox to set the cropping parameters.
Cropping Mode	<p>Set the units used for defining the crop. Options are: <i>Pixels</i> or <i>Percentages</i>.</p> <p>Note: Depending on the type of content, in some cases using different crop values for low resolution outputs might be appropriate. For example, if the content includes both video content and textual content, the text would not be readable at lower resolutions and thus might be better to exclude. Another use case for using different crop values for each output would be to slice a 360 or VR input video.</p>
Left, Top	Specify the left and top positions for the crop.
Width x Height	Specify the width and height values for the crop.
Enable time shift	

Transcoder

Transcoding an Input Stream

Parameter	Description
Maximum delay [hh:mm:ss]	Specify the time of the delayed transmission of this stream. Maximum: 24 hours.
Enable multicast on pull outputs	Selecting this checkbox enables the transmission of this stream's outputs as multicast. A Zixi receiver that will pull the stream will receive it in multicast. By default Zixi Broadcaster is configured to allow transparent fallback to unicast if it is out of the LAN. Requires enabling Multicast Pull in the Settings. This setting requires enabling Multicast Pool (Settings > Multicast Pull Outputs).
Multicast Only	Selecting this checkbox will force the transmission of this stream only in multicast.
Enable Encryption	Select this checkbox to encrypt the Input stream. For more information, see Encrypting an Input Stream in Zixi Broadcaster .
Encryption type (for Encryption enabled)	Specify the type of Encryption (AES 128/192/256).
Encryption key (for encryption enabled)	Click Generate to generate an encryption key. The generated encryption key must be sent to the end-user to decipher the received encoded stream.
Recording parameters	Select this checkbox to customize the recording parameters.
Destination Type	Select the radio button for the desired storage type and then fill in the relevant parameters. <ul style="list-style-type: none">• Record to disk – the recording is saved on the local disk.• Record to S3 – the file is saved to your AWS S3 Bucket.
Record to Disk Parameters	<p>Specify the file name pattern that Zixi will use to generate when saving the recorded content. A separate file will be generated for each recording up to the time specified in the Max recorded file duration parameter (see above). After this duration a new file will be generated.</p> <p>The file name pattern can include any string and up to five variables listed below. Only the %T=HH.MM.SS creation time is mandatory. You can change the order of these variables and add text as long as you maintain the legitimate structure of the file in Linux and Windows:</p> <ul style="list-style-type: none">• %S=stream id - optional.• %Y=year - optional• %M=month - optional
File Name Template	

Transcoder

Transcoding an Input Stream

Parameter	Description
	<ul style="list-style-type: none">• %D=day - optional• %T=HH.MM.SS creation time - mandatory <p>For example, the following pattern %Y_recording%T.ts will generate the following file name 2017_recording15:32:35.ts.</p>
Max recorded file duration [hours]	Specify the maximum time allotted for recording a video stream. Default: 2 hours
Keep recorded files for [hours]	Specify the maximum time for storing the recording. Default: 0 hours
Custom Path	Optionally specify a storage location for the recorded files that is relative to the root folder. This location bypasses the location specified as the root folder in the Settings > General screen.
Record to S3 Parameters	
File Name Template	<p>Specify the file name pattern that Zixi will use to generate when saving the recorded content. A separate file will be generated for each recording up to the time specified in the Max recorded file duration parameter (see above). After this duration a new file will be generated.</p> <p>The file name pattern can include any string and up to five variables listed below. Only the %T=HH.MM.SS creation time is mandatory. You can change the order of these variables and add text as long as you maintain the legitimate structure of the file in Linux and Windows:</p> <ul style="list-style-type: none">• %S=stream id - optional.• %Y=year - optional• %M=month - optional• %D=day - optional• %T=HH.MM.SS creation time - mandatory <p>For example, the following pattern %Y_recording%T.ts will generate the following file name 2017_recording15:32:35.ts.</p>
Max recorded file duration [hours]	Specify the maximum time allotted for recording a video stream. Default: 2 hours
URL	Specify the URL of the S3 bucket.
Ignore TLS certificate errors	TLS certificate for S3 bucket might be detected as faulty if bucket name contains dot[s]. When this option is selected, Zixi Broadcaster will ignore the TLS certificate errors and transmit the stream to its destination.

Transcoder

Transcoding Templates

Parameter	Description
Access Key	The access key that is used for accessing the S3 bucket.
Secret Key	The secret key that is used for accessing the S3 bucket.

Transcoding Templates

Instead of manually selecting input streams to be transcoded, you can define templates with rules for automatic transcoding of input streams according to the settings of a pre-defined Transcoding Template. Every time a new input stream, which matches the conditions of the template, is added, it will be automatically transcoded into the transcoded streams defined in the template's settings. The input streams are identified by system according to naming patterns.



The transcoding profiles used in the transcoding templates have to be created in advance (for more information see [Creating New Profiles](#)).

➔ To create a new transcoding template:

1. Click the **Inputs** tab at the top of the Zixi Broadcaster administrative screen.
2. In the Menu bar, click the Templates () button.

The **Transcoding Templates** window is displayed:

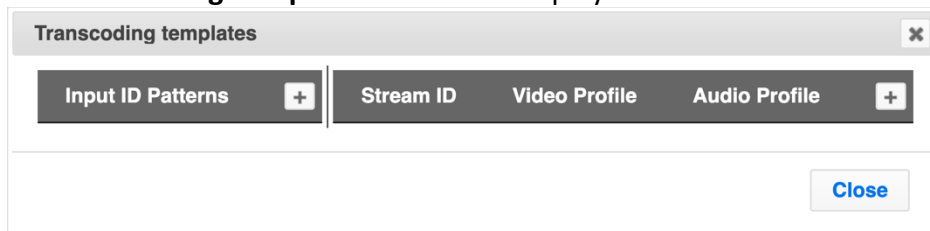

3. Next to **Input ID Patterns**, click  to define a new template.

The following window is displayed:

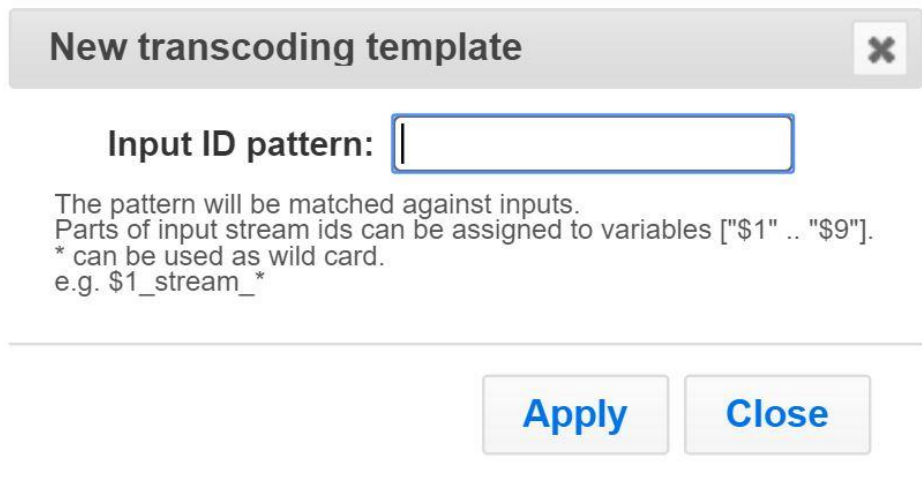

The dialog box is titled "New transcoding template" and has a close button (X) in the top right corner. It contains a text input field labeled "Input ID pattern:". Below the input field, there is explanatory text: "The pattern will be matched against inputs. Parts of input stream ids can be assigned to variables ['\$1' .. '\$9']. * can be used as wild card. e.g. \$1_stream_*". At the bottom of the dialog, there are two buttons: "Apply" and "Close".

4. In the **Input ID pattern** field, enter a pattern for the Stream ID of the input stream that will be automatically transcoded. This pattern will be used to identify the input stream and can include variables that are marked with the "\$" sign followed by a number (e.g. \$1, \$2, etc.) and/or with an asterisk "*" wildcard. The patterns should also include a part of the string that requires an exact match. For example, the pattern "\$1_stream_\$2kbps" will match an input stream "talk_show_stream_600kbps".
5. Click **Apply**.

The new template is added to the list of transcoding templates. However, the transcoding will not be active until you define transcoded stream rules.



The window is titled "Transcoding templates" and has a close button (X) in the top right corner. It features a table with the following columns: "Defined Templates", "Stream ID", "Video Profile", and "Audio Profile". The "Defined Templates" column contains the entry "\$1_livetv_*", which is highlighted with a red box and has a white arrow pointing to it from the right. Below the table, there are "New" and "Delete" buttons. At the bottom right of the window, there is a "Close" button.

Defined Templates	Stream ID	Video Profile	Audio Profile
\$1_livetv_*			

Transcoder

Transcoding Templates

6. Select the newly created template and click the  button, located at the right-hand corner to define a transcoded stream rule.

The **Transcode <template_name>** window opens:

Transcode \$1_stream_\$2kbps 

Stream ID:

Max Outputs:

Show in Matrix:

Stream parameters

Video profile: 

Audio profile: 

Apply audio profile for all audio PIDs:

Output Type: 

Transport stream bitrate [kbps]:

Use Intel hardware acceleration (if available):

Add RTP headers:

Pass all PIDs:

Force I-Frames on SCTE-35 markers

Copy Closed Captions:

Smoothing buffer [ms]:

GPU: 

Crop Parameters

Cropping Mode: 

Left , Top: ,

Width x Height: X

Billing Codes

Enable time shift

Enable multicast on pull outputs

Enable encryption

Recording parameters

7. Enter the unique **Stream ID**. for the transcoded stream.
8. In the **Max Outputs** field, define the maximal number of outputs that can be connected to the stream.

Transcoder

Transcoding Templates

- Under **Stream Parameters**, select the desired Video Profile and/or Audio Profile that you have configured. If you have not configured a video or audio profile you can select **Keep original stream**. In this case the video or audio input will not be transcoded. You can also set specific transcoding parameters for the specific stream (see table below for more details).
- Click **OK**.

The transcoded input stream rule is created and appears as follows:

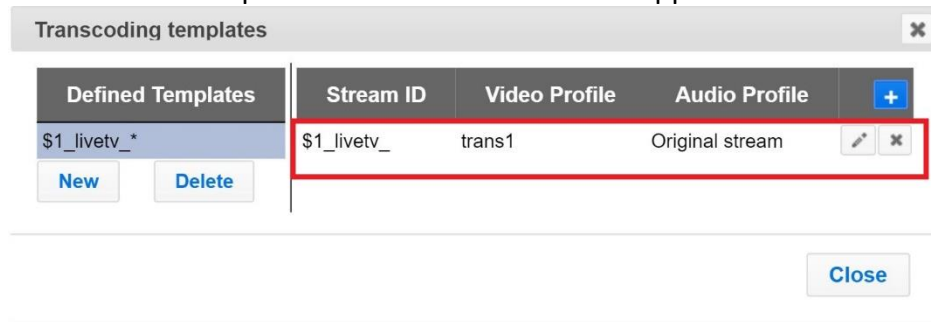

If an input stream enters Zixi Broadcaster and matches the **Input ID pattern**, it will be transcoded according to all the transcoded input stream rules that were created.

Parameter	Description
Video Profile	Select an existing profile or select Keep original stream if you do not wish to transcode the video stream.
Audio Profile	Select an existing profile or select Keep original stream if you do not wish to transcode the audio stream.
Apply audio profile for all audio PIDs	Select this option if you want to re-encode all audio tracks using the same audio profile, instead of just the first audio track that is detected.

Output Type	<p>Select one of the following output types. The outputs are configured as part of the transcoding process, so there is no need to create the Output from the Zixi Broadcaster Outputs screen:</p> <ul style="list-style-type: none">• MPEG-TS – the output will be available as MPEG Transport Stream.• NDI – the output will be available as NDI. When selecting NDI output, you can select the following video/audio profiles:<ul style="list-style-type: none">○ Video profile – remove stream or a Raw profile.○ Audio profile - remove stream or a Raw profile.• WebRTC – the output will be available as WebRTC. When selecting NDI output, you can select the following video/audio profiles:<ul style="list-style-type: none">○ Video profile – remove stream, keep original stream, Raw video profile, or if the input stream is not WebRTC compliant, a transcode to WebRTC compliant profile (e.g. H.264 codec with Baseline or Main profile and no B frames). <p>Audio profile - remove stream, keep original stream, Raw audio profile, or if the input stream is non-Opus, transcode to Opus.</p>
Transport Stream Bitrate (Kbps)	<p>Specify the bitrate of the transport stream. This parameter is optional. If you do not specify a TS Bitrate, the stream will be VBR. If you specify a bitrate, the stream will be CBR.</p>
Use Intel hardware acceleration (if available)	<p>Select this checkbox to use hardware acceleration component if it has been installed.</p>
Add RTP headers	<p>Select this checkbox to add RTP headers to the stream. RTP adds a 12-byte header, which includes a sequence number and a timestamp that can be used to detect dropped packets. The sequence number in the RTP headers can be used to do automatic reordering and the timestamps can help overcome inter-packet gaps, also known as IAT (Inter Arrival Time).</p> <p>However, plain RTP does not feature error recovery or error protection. By default, the RTP headers (which include the timestamps and sequences) are being used on the input side, but then they are stripped off and they no longer propagate to outputs.</p>
Pass all PIDs	<p>Select this checkbox to pass-through all non-transcoded PIDs.</p>

Transcoder

Transcoding Templates

Force I-Frames on SCTE-35 markers	<p>Selecting this option will do the following:</p> <ul style="list-style-type: none">• If a SCTE35 marker is detected and it contains a specific video timestamp (PTS), the encoder will generate an IDR-frame on the video frame with the closest or equal timestamp.• If there is no timestamp in the SCTE35 marker, the transcoder will generate an IDR frame as soon as it can.
Copy Closed Captions	<p>If the video source contains closed caption, select whether to drop them or copy them to the encoded video streams. Relevant for HEVC and h264 sources and targets.</p>
Smoothing buffer [ms]	<p>The Smoothing feature uses a buffer to time packets according to the stream's clock. This is useful when there are bursts in the rate in which the stream arrives. The smoothing features creates a queue in the buffer, allowing smoother entry into the Broadcaster. The Smoothing parameter defines the size of the buffer in Milliseconds. A larger the buffer enables smoother entry. However, it may influence the latency rate.</p>
GPU	<p>The GPU utilization threshold. If this limit is exceeded, the GPU indicator at the top of the screen will appear in red, and an alarm will be generated in the event log.</p> <p>Default: 0</p>
Crop Parameters	<p>Select this checkbox to set the cropping parameters.</p>
Cropping Mode	<p>Set the units used for defining the crop. Options are: <i>Pixels</i> or <i>Percentages</i>.</p> <p>Note: Depending on the type of content, in some cases using different crop values for low resolution outputs might be appropriate. For example, if the content includes both video content and textual content, the text would not be readable at lower resolutions and thus might be better to exclude. Another use case for using different crop values for each output would be to slice a 360 or VR input video.</p>
Left, Top	<p>Specify the left and top positions for the crop.</p>
Width x Height	<p>Specify the width and height values for the crop.</p>
Billing Codes	<p>Billing codes are used to identify and differentiate traffic on a Zixi Broadcaster for billing purposes. When a billing code is added to a Source or Target, Zixi can track the traffic on that Broadcaster input or output separately from other inputs and outputs on the same Broadcaster. Billing codes are created by Zixi personnel on the Zixi Customer Portal for a particular organization.</p>
Billing Code	<p>Enter the billing code that corresponds to this stream. The relevant billing can be obtained from the organization that received the billing code from Zixi.</p>

Transcoder

Transcoding Templates

Billing password	Enter the password that corresponds to this billing code.
Enable time shift	Select to enable delayed transmission.
Maximum delay [hh:mm:ss]	Specify the time of the delayed transmission of this stream. Maximum: 24 hours.
Enable multicast on pull outputs	Selecting this checkbox enables the transmission of this stream's outputs as multicast. A Zixi receiver that will pull the stream will receive it in multicast. By default Zixi Broadcaster is configured to allow transparent fallback to unicast if it is out of the LAN. Requires enabling Multicast Pull in the Settings. This setting requires enabling Multicast Pool (Settings > Multicast Pool).
Multicast Only	Selecting this checkbox will force the transmission of this stream only in multicast.
Enable encryption	Select this checkbox to encrypt the Input stream. For more information, see Encrypting an Input Stream in Zixi Broadcaster .
Recording Parameters	Select this checkbox to customize the recording parameters.
Destination Type	Select the radio button for the desired storage type and then fill in the relevant parameters. <ul style="list-style-type: none">• Record to disk – the recording is saved on the local disk.• Record to S3 – the file is saved to your AWS S3 Bucket.
Record to Disk Parameters	

Transcoder

Transcoding Templates

File Name Template	<p>Specify the file name pattern that Zixi will use to generate when saving the recorded content. A separate file will be generated for each recording up to the time specified in the Max recorded file duration parameter (see above). After this duration a new file will be generated.</p> <p>The file name pattern can include any string and up to five variables listed below. Only the %T=HH.MM.SS creation time is mandatory. You can change the order of these variables and add text as long as you maintain the legitimate structure of the file in Linux and Windows:</p> <ul style="list-style-type: none">• %S=stream id - optional.• %Y=year - optional• %M=month - optional• %D=day - optional• %T=HH.MM.SS creation time - mandatory <p>For example, the following pattern %Y_recording%T.ts will generate the following file name 2017_recording15:32:35.ts.</p>
Max recorded file duration [hours]	Specify the maximum time allotted for recording a video stream. Default: 2 hours
Keep recorded files for [hours]	Specify the maximum time for storing the recording. Default: 0 hours
Custom Path	Optionally specify a storage location for the recorded files that is relative to the root folder. This location bypasses the location specified as the root folder in the Settings > General screen.
Record to S3 Parameters	

Hardware Acceleration Checklist

File Name Template	<p>Specify the file name pattern that Zixi will use to generate when saving the recorded content. A separate file will be generated for each recording up to the time specified in the Max recorded file duration parameter (see above). After this duration a new file will be generated.</p> <p>The file name pattern can include any string and up to five variables listed below. Only the %T=HH.MM.SS creation time is mandatory. You can change the order of these variables and add text as long as you maintain the legitimate structure of the file in Linux and Windows:</p> <ul style="list-style-type: none">• %S=stream id - optional.• %Y=year - optional• %M=month - optional• %D=day - optional• %T=HH.MM.SS creation time - mandatory <p>For example, the following pattern %Y_recording%T.ts will generate the following file name 2017_recording15:32:35.ts.</p>
Max recorded file duration [hours]	Specify the maximum time allotted for recording a video stream. Default: 2 hours
URL	Specify the URL of the S3 bucket.
Ignore TLS certificate errors	TLS certificate for S3 bucket might be detected as faulty if bucket name contains dot[s]. When this option is selected, Zixi Broadcaster will ignore the TLS certificate errors and transmit the stream to its destination.
Access Key	The access key that is used for accessing the S3 bucket.
Secret Key	The secret key that is used for accessing the S3 bucket.

11. Repeat steps 6-10 above to create additional transcoded input stream rules.

Hardware Acceleration Checklist

The Hardware Acceleration Checklist feature checks for the necessary hardware components to support Intel hardware acceleration for transcoding. If the existing hardware matches the requirements, an Install button appears. Clicking it will install a kernel, which includes the Linux kernel with the Intel patches that enable hardware acceleration. After the installation, the system will reboot and thereafter it will support Intel hardware acceleration.

Transcoder

Hardware Acceleration Checklist

➔ To run the hardware acceleration checklist:

1. In the Transcoder page, click [Intel Hardware Acceleration Checklist](#).

The **Hardware Acceleration Checklist** window is displayed:

	Test	Result	Action
	Operating System	CentOS Linux release 7.2.1511 (Core)	
	CPU	Intel(R) Xeon(R) CPU E3-1275L v3 @ 2.70GHz detected	
	GPU	Not Found	Intel Iris Pro Graphics or Intel Iris Graphics or Intel HD Graphics is required
	Intel Media Server Studio	Not installed	
	Hardware Encoding Test	Failed to init HW session. Error=Unsupported feature	

The machine does not meet the minimum requirements for hardware transcoding

[Test Again](#) [Close](#)

2. The checklist displays each required hardware component with the following statuses:
 - **Green** – the hardware/software component was found
 - **Orange** - the hardware component was found but the software was not installed.
 - **Red** - the hardware/software was not found.

Server Settings

Zixi Broadcaster is pre-configured with default settings, so generally there is no need to change the server settings. However, some users may want to change specific settings to meet their specific needs.

General

The General Settings screen includes basic configuration parameters for the server including the server’s ID, access ports, authorizations, security, and storage.

The screenshot shows the Zixi Broadcaster Settings interface. At the top, there is a navigation bar with tabs: STATUS, INPUTS, OUTPUTS, ADAPTIVE, VOD, FILES, TRANSCODER, SETTINGS (selected), EVENT LOG, MATRIX, and LOGOUT. The current page is the 'Settings' screen, with a sidebar on the left containing a menu of settings categories: General, Network, Time, Live Protocols, Multicast Pull Outputs, File Transfer & VOD, Cluster, ZEN Master, SSH Connections, Authorization, Logging, ASI, Threads, Transcoder, SCTE35 Report, and Billing Codes. The 'General' settings are displayed in the main area, including fields for ID, Machine local time, Web server port, Admin username, and Admin password. There are also checkboxes for enabling read/write user, read-only user, and HTTPS administration. A dropdown menu for TR101 analyzer mode is set to 'None'. Below these are sections for 'Input Ports' and 'Output Ports', each with a table of port configurations. The 'Limits' section is partially visible at the bottom.

Field	Description
-------	-------------

General

Server Settings

General

ID	The unique (alphanumeric) name of the Zixi Broadcaster server. Typically: host name. This field is editable.
Machine local time	Shows the current time for the machine.
Web Server Port	The port number of the web server administration. You can configure this parameter to any legal port number which is supported by your Firewall. Default: 4444
Admin User Name	The user name of the administrator. The administrator is authorized to modify all parameters in the system as well as manage all the outputs and inputs on the server.
Admin Password	The password of the administrator.
Enable read / write user - except for settings screen	Select this checkbox to enable an "Operator" user. This type of user can read and write throughout all of the screens, except for the screens under the Settings menu. You can modify the user name (i.e. enter another name instead of Operator) and password.
Enable read-only user +ability to switch streams	Select this checkbox to enable a "User" user. This type of user can read throughout all of the screens as well as the ability to switch between existing streams. You can modify the user name (i.e. enter another name instead of User) and password.
Username	The account Username.
Password	The account password.
Enable read only user	Select this checkbox to enable an "Observer" user. This type of user can read throughout all of the screens. You can modify the user name (i.e. enter another name instead of Observer) and password.
Enable HTTPS administration	Enables secure HTTPS connection to the server for administration. Enabling HTTPS requires the relevant certificates and private keys. To enable HTTPS, click on the checkbox and upload the required files.
HTTPS certificate uploaded (for HTTPS enabled)	If no certificate has been uploaded, click Upload and navigate to the file location.
HTTPS private key uploaded (for HTTPS enabled)	If no private key has been uploaded, click Upload and navigate to the file location.
HTTPS private key passphrase (for HTTPS enabled)	Enter the Private key passphrase for your HTTPS account.

Server Settings

General

SSL Setup Status	Displays the status of the SSL certificate upload process. Incomplete – the SSL setup process is incomplete. OK – the SSL setup process is complete.
Root folder	Displays the configured root folder. You can modify the root folder by modifying the broadcaster-info.xml, which is located in the Zixi Broadcaster installation folder (<Broadcaster_Installation_Folder>\Zixi\Broadcaster\)
TR101 analyzer mode	Select the mode in which the TR101 analyzer will operate: None – no TR101 analysis ATSC – based on the Advanced Television Systems Committee recommendations. DVB – based on the Digital Video Broadcasting specifications.
Enable audio levels in matrix	Select this option to enable audio in Matrix view. When not selected the audio will be turned off.

Count per-PID statistics on push/pull inputs

HTTPS and DTLS Streaming Certificate

Certificate uploaded (for DTLS enabled) If no certificate has been uploaded, click Upload and navigate to the file location.
Note: This is the same certificate as the HTTPS certificate.

Private key uploaded (for DTLS enabled) If no private key has been uploaded, click Upload and navigate to the file location.

Private key passphrase (for DTLS enabled) Enter the Private key passphrase for your DTLS account.

SSL setup status Displays the status of the SSL certificate upload process.
Incomplete – the SSL setup process is incomplete.
OK – the SSL setup process is complete.

Input ports

Port The port that is used for Input streams. You can modify the port number and/or add additional ports by adding a “,” between them.
Adding additional ports may be necessary when there is a chance that the ISP will block a certain port. Click '+' to add additional ports.
Default: 2088

IP Enter an IP address. The default enables **Any** IP address.

Server Settings

General

DTLS	Click the DTLS check box to activate DTLS automatic encryption of the streams.
-------------	--

+ (add ports)	Click + to add additional ports. Note: For each port you can select whether or not to activate DTLS encryption. This enables streaming of non-encrypted streams on one port and encrypted streams on a separate port.
----------------------	---

Output ports

Port	The port that is used for the Output streams. Displays the Output port(s). You can modify the port number and/or add additional ports by adding a “,” between them. Adding additional ports may be necessary when there is a chance that the ISP will block a certain port. Click '+' to add additional ports. Default: 2077
-------------	---

IP	Enter an IP address. The default enables Any IP address.
-----------	---

DTLS	Click the DTLS check box to activate DTLS automatic encryption of the streams.
-------------	--

+ (add ports)	Click + to add additional ports. Note: For each port you can select whether or not to activate DTLS encryption. This enables streaming of non-encrypted streams on one port and encrypted streams on a separate port.
----------------------	---

Limits	Select to configure thresholds for generating an alarm.
---------------	---

CPU [%]	The CPU utilization threshold. If this limit is exceeded, the CPU indicator at the top of the screen will appear in red, and an alarm will be generated in the event log. Default: 90
----------------	--

Memory [%]	The memory utilization threshold. If this limit is exceeded, the Memory indicator at the top of the screen will appear in red, and an alarm will be generated in the event log Default: 90
-------------------	---

Max disk quota [%]

GPU [%]	The GPU utilization threshold. If this limit is exceeded, the GPU indicator at the top of the screen will appear in red, and an alarm will be generated in the event log. Default: 0
----------------	---

Input Bandwidth [kbps]	Bandwidth utilization threshold for input streams. Default: Unlimited.
-------------------------------	---

Output Bandwidth [kbps]	Bandwidth utilization threshold for output streams. Default: Unlimited.
--------------------------------	--

Server Settings

General

Server Settings

Network

Network

The Network screen enables the configuration of the network settings of the Zixi Broadcaster. The screen includes the option to configuration multiple NICs, VLANs, and multiple DNS Servers.

Settings

Network Settings

eth0

Speed: Duplex: Full MTU: 9001

Custom link setting

IP	Mask	Gateway	DHCP	VLAN
172.31.22.212	255.255.240.0	172.31.16.1	Yes	No

DNS Servers

Use DHCP DNS settings:

DNS1: 172.31.0.2

DNS2:

Apply

Field	Description
-------	-------------

Network Settings

Click to configure the specified NIC. Displays the following parameters:

- Speed – the network card speed
- Duplex – whether the network card is full-duplex or half-duplex
- MTU - the size of the largest protocol data unit (PDU) that can be communicated in a single network layer transaction.

Custom link settings

Select this checkbox to configure different link settings than the default settings.

Addresses

Displays the current IP address that is configured for the link. You edit these settings by clicking the Edit (pencil icon) button. Click the '+' button to add another link.

DNS Servers

Server Settings

Network

Use DHCP DNS settings Select this option to use the DHCP settings instead of the DNS. If not selected, configure at least one DNS server.

➔ To Display Network Statistics:

1. From the Settings page of the Zixi Broadcaster, click **Network** on the left-hand side. The various Network settings are displayed.
2. Click  on the right-hand side. The **UDP statistics** window is displayed.

Field	Description
####Packets received	Number of packets on network received.
####packets to unknown port received	Number of packets to unknown port on network received.
####packet receive errors	Number of packets on network which received errors
####packets sent	Number of packets on network sent.
####SndbufErrors	Number of Sent buffer errors

Click the **Refresh** button to update the data or **Close** to close the window

Server Settings

Time

Time

The Time screen enables the configuration of the system time synchronization for the system. The time can be synchronized with the machine local time or to an external NTP server.

The screenshot shows the Zixi Broadcaster web interface. At the top, there is a navigation bar with tabs for STATUS, INPUTS, OUTPUTS, ADAPTIVE, VOD, FILES, TRANSCODER, SETTINGS (selected), EVENT LOG, and MATRIX. A green bar at the top right contains the text 'LOGOUT'. Below the navigation bar, the 'Settings' page is displayed. On the left is a sidebar menu with options: General, Network, Time (selected), Live Protocols, Multicast Pull Outputs, File Transfer & VOD, Cluster, ZEN Master, SSH Connections, Authorization, Logging, ASI, Threads, Transcoder, SCTE35 Report, and Billing Codes. The main content area is titled 'NTP settings' and includes a 'Machine time' section showing '2022-09-05 09:49:06 UTC' and 'Machine local time: 2022-09-05 09:49:07', with a 'Set' button. Below that is a 'Service' dropdown menu set to 'On'. The 'NTP Servers' section shows a table with one entry: 'Host' with the value '169.254.169.123'. There are '+', 'Refresh', and 'Apply' buttons in this section.

Field	Description
-------	-------------

NTP Settings

Machine Time	Displays the current machine local time. To set the time click Set and modify the values.
---------------------	--

Service	Click the button to Start/Stop the NTP Service.
----------------	---

NTP Servers	Configure external NTP servers for time synchronization. Click the + button to add an NTP server and specify the Host IP address.
--------------------	---

Live Protocols

The Live Protocols screen enables the configuration of the HTTP/HTTPS/RTMP/WebSocket server that will broadcast the streams using live streaming protocols, particularly for adaptive streaming and internet protocols.

Settings Export Import Delete Settings

General **Network** **Time** **Live Protocols** **Multicast Pull Outputs** **File Transfer & VOD** **Cluster** **ZEN Master** **SSH Connections** **Authorization** **Logging** **ASI** **Threads** **Transcoder** **SCTE35 Report** **Billing Codes**

HTTP Server

HTTP/HTTPS server public IP:

Enable HTTP server:

HTTP server port:

Enable HTTPS server:

HTTPS server port:

HTTPS certificate uploaded: Yes

HTTPS private key uploaded: Yes

HTTPS private key passphrase:

SSL setup status: OK

Enable WebSocket server:

WebSocket server port:

Enable FLV:

Enable HLS:

Enable CMAF(DASH + fMP4 HLS):

Enable SHOUTcast:

Enable HLS fast playback:

Sub-GOP HLS fast playback:

HLS DVR maximum recording duration [HH:MM]:

Allow automatic HTTP push input:

Allow automatic HTTP pull output:

RTMP Server

Enable RTMP Server:

RTMP server port:

Allow automatic RTMP input:

Allow automatic RTMP output:

Field	Description
HTTP Server	
HTTP/HTTPS Server Public IP	Override the Zixi IP (e.g. download.Zixi.com) with a public IP.
Enable HTTP Server	Enable a non-secure connection over HTTP.
HTTP Server Port	Defines the HTTP Server Port. Default:7777
Enable HTTPS	Enable a secure connection over HTTPS.

Server Settings

Live Protocols

Server

HTTPS Server Port Defined the HTTPS server port. Default: 443

HTTPS certificate uploaded (for HTTPS enabled) If no certificate has been uploaded, click Upload and navigate to the file location.

HTTPS private key uploaded (for HTTPS enabled) If no private key has been uploaded, click Upload and navigate to the file location.

HTTPS private key passphrase (for HTTPS enabled) Enter the Private key passphrase for your HTTPS account.

SSL Setup Status Displays the status of the SSL certificate upload process.
Incomplete – the SSL setup process is incomplete.
OK – the SSL setup process is complete.

Enable WebSocket server Select checkbox to enable the WebSocket server. The WebSocket server uses the WebSocket protocol to stream content. The WebSocket protocol provides full-duplex communication channels over a single TCP connection.

WebSocket Server Port If you have enabled WebSocket, enter a dedicated port for WebSocket. (Default: 8100)

Enable FLV Enable the streaming via the FLV protocol.

Enable HLS Enable the streaming via the HLS protocol.

Enable CMAF (DASH + fMP4 HLS) Enable the streaming via the CMAF protocol.

Enable SHOUTcast Enable the streaming via the SHOUTcast protocol.

Enable HLS Fast playback Enables low latency HLS and DASH. When this setting is enabled, all input streams on the Zixi Broadcaster will be published to the origin server as HLS streams, so only enable this feature if it will be actually used.

Sub-GOP HLS Fast playback Select this option to enable publishing of HLS chunk before the response is complete. This means that Zixi Broadcaster will start sending the HTTP response as chunks of data when they are ready before the complete response is available.

HLS DVR maximum recording duration Defines the maximum recording duration for HLS DVR. Default: 24 hours. [HH:MM]:

Allow Automatic HTTP Push input Automatically creates an HTTP Push input without the need to define it in the Input screen.

Server Settings

Live Protocols

Allow Automatic HTTP Pull output

Automatically creates an HTTP Pull output without the need to define it in the Output screen. This works in tandem with Zixi Feeder (Remote HTTP Pull Output setting, which enables sending a Zixi-protected stream to Zixi Broadcaster and then Zixi Broadcaster automatically outputs the stream as HTTP Pull) and SDK (which includes a `zixi_http_pull_out_config` option). By enabling this option, the HTTP Pull streams will be automatically created as they arrive into Zixi Broadcaster and displayed in the Output screen.

RTMP Server

Enable RTMP Server

Enables Zixi Broadcaster to handle incoming RTMP streams.

RTMP Server Port

The port through which the RTMP stream will be transmitted. Default: 1935

Allow Automatic RTMP Input

Automatically creates an RTMP input without the need to define it in the Input screen.

Allow Automatic RTMP Output

Automatically creates an RTMP output without the need to define it in the Output screen. This works in tandem with Zixi Feeder (**Remote RTMP Output** setting, which enables sending a Zixi-protected stream to Zixi Broadcaster and then Zixi Broadcaster automatically outputs the stream as RTMP) and SDK (which includes a `zixi_rtmp_out_config` option). By enabling this option, the RTMP streams will be automatically created as they arrive into Zixi Broadcaster and displayed in the Output screen.

Multicast Pull Outputs

Multicast Pull Outputs is a collection of multicast IP addresses that automatically assign a multicast IP when an input is being pulled out of the Zixi Broadcaster. When the “multicast pool” setting is enabled, you do not have to define a specific multicast IP address for every push stream. Instead, you simply enable the Multicast Only parameter and Zixi Broadcaster will assign the multicast IP automatically when it pulls the stream out. When the multicast stream is connected, it will appear in the Status table at the bottom of the screen.

The screenshot shows the Zixi Broadcaster interface. At the top, there's a navigation bar with tabs: STATUS, INPUTS, OUTPUTS, ADAPTIVE, VOD, FILES, TRANSCODER, SETTINGS (selected), EVENT LOG, MATRIX, and LOGOUT. Below the navigation bar, there's a 'Settings' section with a sidebar on the left containing various settings categories: General, Network, Time, Live Protocols, Multicast Pull Outputs (selected), File Transfer & VOD, Cluster, ZEN Master, SSH Connections, Authorization, Logging, ASI, Threads, Transcoder, SCTE35 Report, and Billing Codes. The main content area is titled 'Configuration' and contains the following settings:

- Allow:
- Multicast pool address range:
e.g. 225.5.0.0 / 16 would give a range 225.5.0.0 ~ 225.5.255.255
- Port:
- NIC:
- TTL:

Below the configuration fields, there's a note: "FEC Settings will be used for any multicast enabled input" and an "Apply" button. At the bottom of the configuration area, there's a 'Status' section with a table header: Stream, IP, Multicast, Unicast. The table content is empty, showing "No data available in table".

Field	Description
Configuration	
Allow	Allows multicast pool
Multicast pool address range	Specify the range of IP addresses (CIDR format).
Port	Specify the port that will be shared by all of the members of the pool.
NIC	Specify the network card to use for the outgoing multicast traffic.
TTL	Specify the Time To Live.

File Transfer & VOD

Server Settings

File Transfer & VOD

The File Transfer and VOD settings screen enables the download of files and the playback of VOD content and, in addition, specifies the speed limits (download/upload). The settings in this screen are related to the VOD and Files screens.

The screenshot shows the Zixi Broadcaster settings interface. At the top, there's a navigation bar with 'STATUS', 'INPUTS', 'OUTPUTS', 'ADAPTIVE', 'VOD', 'FILES', 'TRANSCODER', 'SETTINGS', 'EVENT LOG', 'MATRIX', and 'LOGOUT'. Below this is a 'Settings' section with 'Export', 'Import', and 'Delete Settings' buttons. A sidebar menu on the left lists various settings categories, with 'File Transfer & VOD' highlighted. The main content area is titled 'File Transfer & VOD' and contains the following settings:

- Download:
- HTTP input:
- Upload:
- Automatically index VOD files:
- Scan on startup:
- HLS Indexing:
- MPEG-DASH Indexing:
- VOD:
- Encrypt downloads:
- Max download speed [kbps]: ~100.0 Mbit/s
- Max upload speed [kbps]: ~100.0 Mbit/s
- Initial bitrate [kbps]: ~15.0 Mbit/s
- HTTP/Origin cache size [MB]:

An 'Apply' button is located at the bottom right of the settings area.

Field	Description
File Transfer & VOD	
Download	Enables download of files through the Files menu of the Zixi Broadcaster.
HTTP Input	Enables HTTP acceleration mode. In this mode, instead of specifying a file location on the server's hard disk, the Zixi Broadcaster receives an HTTP address from which it will retrieve the file and then transfer it to the Client.
Upload	Enables upload of files through the Files menu of the Zixi Broadcaster
Automatically index VOD files	Indexes the VOD files in the various VOD folders. In some cases, the indexing of VOD files can affect performance. Using this control, you can decide when to index the VOD files in order to ensure optimal performance during peak times.
Scan on startup	Indexes the files in the VOD folder that have not been indexed during startup of the Zixi Broadcaster.

Server Settings

File Transfer & VOD

HLS indexing	Enables indexing of HLS streams. The indexing creates an M3U8 playlist file.
MPEG-DASH indexing	Enables indexing of MPEG-DASH streams. The indexing creates a .mpd (MPEG-DASH Media Presentation Description) file.
VOD	Enables the VOD feature.
Encrypt downloads	Encrypts files that are downloaded.
Max download speed [kbps]	Limits the amount of bandwidth used to download files
Max upload speed [kbps]	Limits the amount of bandwidth used to upload files
Initial bitrate [kbps]	Limits the amount of bandwidth used during initial download/upload (before cache)
HTTP/Origin cache size [MB]	Limits the amount of cache memory that can be used for cache

Cluster

Zixi Broadcaster enables two types of configurations:

- **Cluster configuration** - a cluster of Zixi Broadcaster servers in a LAN for load balancing purposes. The different Zixi Broadcaster servers will communicate with each other and are “aware” of the Input/Output traffic of each node in order to redirect the streams to the least occupied Zixi Broadcaster instance. All Zixi Broadcasters should have a separate **Public IP** (NIC #1) and in addition, they all should have an internal IP on the LAN (**Cluster Internal IP**) to communicate over multicast (NIC #2). When a request received by the Zixi Broadcaster, it accepts it, or transmit it internally to another Zixi Broadcaster that is less loaded and has the requested channel. The Cluster feature is currently supported for:
 - Inputs - Zixi Push inputs
 - Outputs - Zixi Pull outputs, HLS outputs



If you want to use more advanced load balancing and high availability features, instead of configuring the cluster within each Zixi Broadcaster (as described below) it is recommended to configure the cluster within ZEN Master, which requires a single cluster configuration and then automatically manages the load balancing and high-availability, while enabling monitoring, reporting, and other advanced features. For more information, see:

<https://zixidocumentation.atlassian.net/wiki/spaces/ZMUG/pages/388005967/Adding+a+Broadcaster+Cluster+Automatic+Scaling>.

- **Edge-Origin configuration** - the cluster may be used to forward the stream from one Zixi Broadcaster server (origin) to other Zixi Broadcaster servers (edge) which are closer to the user or is located in a less sensitive environment. When the end-user connects to the edge server to view a certain stream, the edge server will retrieve the stream from the origin server and will seamlessly deliver it to the end-user.

Server Settings

Cluster

ZIX Broadcaster Version 16.2.44355 Linux 64-bit QA-max-v15-sanity-01-g9lv Copyright (c) 2007, Zixi LLC. CPU: 5.32% Disk: 31.04% Mem: 16.42% Clock: 10:26:47

[STATUS](#)
[INPUTS](#)
[OUTPUTS](#)
[ADAPTIVE](#)
[VOD](#)
[FILES](#)
[TRANSCODER](#)
[SETTINGS](#)
[EVENT LOG](#)
[MATRIX](#)
[LOGOUT](#)

Settings
[Export](#)
[Import](#)
[Delete Settings](#)

General

Network

Time

Live Protocols

Multicast Pull Outputs

File Transfer & VOD

Cluster

ZEN Master

SSH Connections

Authorization

Logging

ASI

Threads

Transcoder

SCTE35 Report

Billing Codes

Origin

Enabled:

Host: Port:

Alternative host: Port:

HTTP/Origin cache size [MB]:

Live Streams

Latency [ms]:

Timeout [s]:

[Apply](#)

Cluster

Enabled:

Public IP:

Cluster internal IP: TTL:

Port:

Local IP:

Balance inputs:

Balance outputs:

[Apply](#)

Field	Description
Origin	
Enabled	Enables Edge-Origin configuration.
Host	The primary host IP address of the origin server.
Port	The port number in the origin server for transmitting the stream. Default: 2088
Alternative Host	The IP address for a secondary server. If the primary origin server is unavailable, the data will be retrieved from the secondary origin server.
Port	The port number for the secondary origin server. Default: 2088
HTTP/origin cache size [MB]	The size of the cache that will be used to serve multiple users. The edge server will retrieve the data from the origin and cache it for additional users in order to save bandwidth and increase performance.
Live Streams	
Latency [ms]	Specify the buffer size between the edge and the origin.

Server Settings

Cluster

Timeout [s]	Specify the maximum amount of time in which the edge will attempt to connect to the origin. After the timeout period the edge server will attempt a connection with the secondary origin server.
Cluster	
Enabled	Enables Cluster configuration.
Public IP	The public-facing IP address of this Zixi Broadcaster server for external access. A unique Public IP must be assigned to each broadcaster in the cluster.
Cluster Internal IP	The internal IP (multi-cast) address for communication between the various servers in the cluster. This address is used to communicate load information forwarding the streams within the cluster. The same multicast IP address should be used across all instances in the cluster.
TTL	Specify the Time To Live parameter.
Port	Specify the port that are used in all the participating Broadcaster servers in the cluster.
Local IP	Specify the local IP address which the network employs for internal communication.
Balance Inputs	Enables the balancing of the inputs.
Balance Outputs	Enables the balancing of the outputs.

Zen Master

The ZEN Master screen is used to add the current Zixi Broadcaster to an existing Broadcaster Cluster in Zen Master that has been configured for "Manual Scaling". This process involves pre-configuring a "manual scaling" Broadcaster Cluster in ZEN Master, then, still in ZEN Master, creating a manual Zixi Broadcaster within this cluster, and then finally from the ZEN screen of the current Zixi Broadcaster UI, selecting the previously created Broadcaster Cluster and Zixi Broadcaster (that we had created though the ZEN Master UI). This process will generate a connection between the logical representation of the Zixi Broadcaster in ZEN Master and the Zixi Broadcaster system.

➔ To connect the current Zixi Broadcaster to ZEN Master:

1. In **ZEN Master**, create a "manual scaling" Broadcaster Cluster and add a Broadcaster entity to it by following the procedure described in the **Adding a Broadcaster Cluster – Manual Scaling** section in the **ZEN Master User Guide**.
2. In ZEN Master, in the main navigation, click **Settings**.
3. In the **SSH Keys** tab, click **Download** on the relevant SSH Key to download the key to your machine.
4. Login to the **Zixi Broadcaster** UI (it could be a locally installed Zixi Broadcaster, e.g. `http://localhost:4444` or a remote Zixi Broadcaster).
The Zixi Broadcaster UI opens.
5. Go to **Settings > ZEN Master**.

The ZEN Master login fields are displayed:

The screenshot shows the Zixi Broadcaster Settings page. The top navigation bar includes STATUS, INPUTS, OUTPUTS, ADAPTIVE, VOD, FILES, TRANSCODER, SETTINGS, EVENT LOG, MATRIX, and LOGOUT. The current page is Settings, with sub-tabs for Export, Import, and Delete Settings. The left sidebar lists various settings categories, with ZEN Master selected. The main content area shows the ZEN Master login form, which includes a 'Sign In' heading, input fields for Account ID, Email, and Password, and a LOGIN button. The footer of the page indicates '2019 © Zixi LLC. All rights reserved.'

Server Settings

Zen Master

6. In the **Account ID** field, enter the customer domain of your ZEN Master account (e.g. if you login to ZEN at *demo.zen.zixi.com* then your Account ID is 'demo').



The user cannot be an SSO (Single Sign-On) user. If you are using an SSO account, you will have to create another user to sign in through this screen.

7. In the **Email** field, enter the username for your ZEN Master account.
8. In the **Password** field, enter the password from your ZEN Master account.
9. Click **Login**.
A list of Broadcasters configured in ZEN Master is displayed.
10. For the Broadcaster that you are adding, which should currently be in **Pending** mode, click **Select**.
Details about the Broadcaster are shown in the **Status**
11. Click **Refresh**.
The connection is configured automatically.
12. In **ZEN Master**, in the main navigation, click **Broadcasters**.
13. Verify that the status of the newly configured Broadcaster cluster is **OK**.
14. Verify that the status of each Broadcaster that was added to the cluster has changed from **Pending** to **OK**.

Status	Name	IP	SSH Key	Streams	CPU	RAM	Version	Actions
Ok	Demo	54.83.40.212	demo_ssh_key	59	13.41%	79.53%	1.13.1.36841	Info Edit Refresh Delete

SSH Connections

SSH (Secure Shell) is a network protocol that allows a secure access over an encrypted connection. Reverse SSH is a technique that can be used to access systems (that are behind a firewall) from the outside world. As part of the SSH configuration, you can configure a connection to the server and then configure any number of SSH tunnels to the same server.

➔ To create an SSH connection to a server:

1. Click the **Add Connections** button.

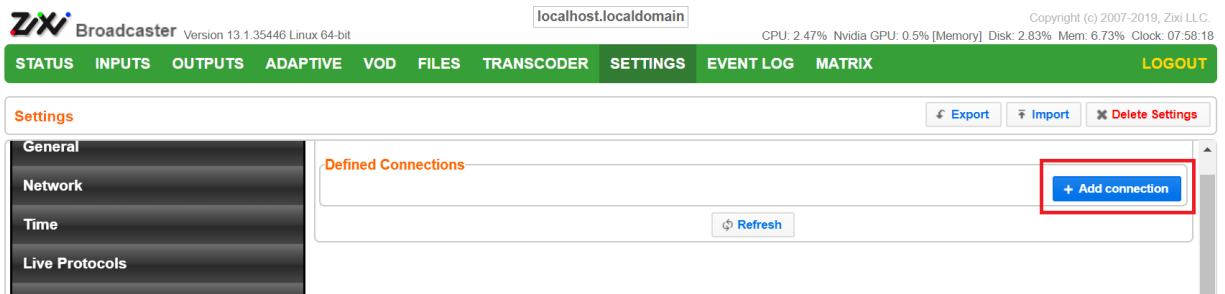

The **Add SSH connection** dialog appears.

2. In the **Host** field, enter the IP address or host name of the host that you wish to access.
3. In the **Port** field, enter the port number to access the host.
4. Click **Apply**.

The connection to the specified server is configured.

➔ To create a reverse tunnel to the same server:

1. Under the destination that you have configured, click **Edit Credentials**.

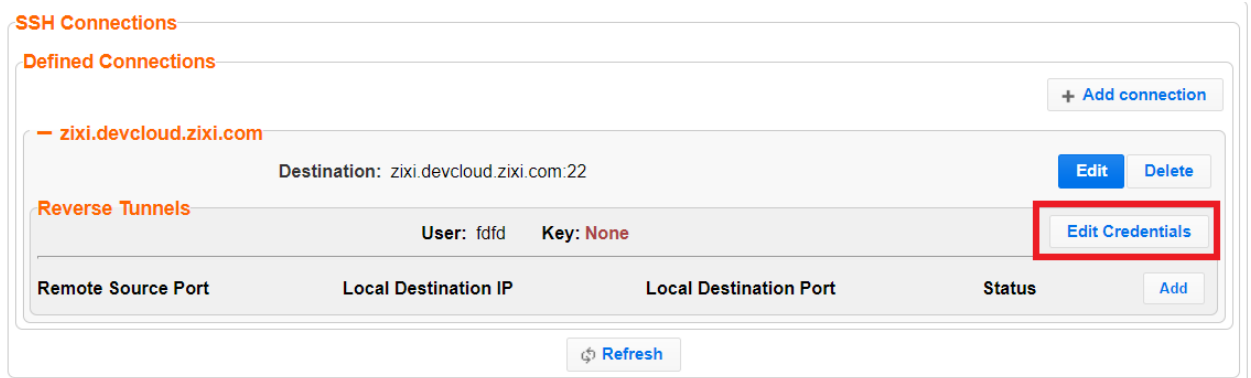

The **Connection Credentials** dialog appears.

2. In the **User** field, enter the username to access the tunnel.
3. Click **Private Key**, navigate to the file location and select the file.
4. Click **Apply**.

Server Settings

SSH Connections

5. Click **Add** to add a reverse tunnel.

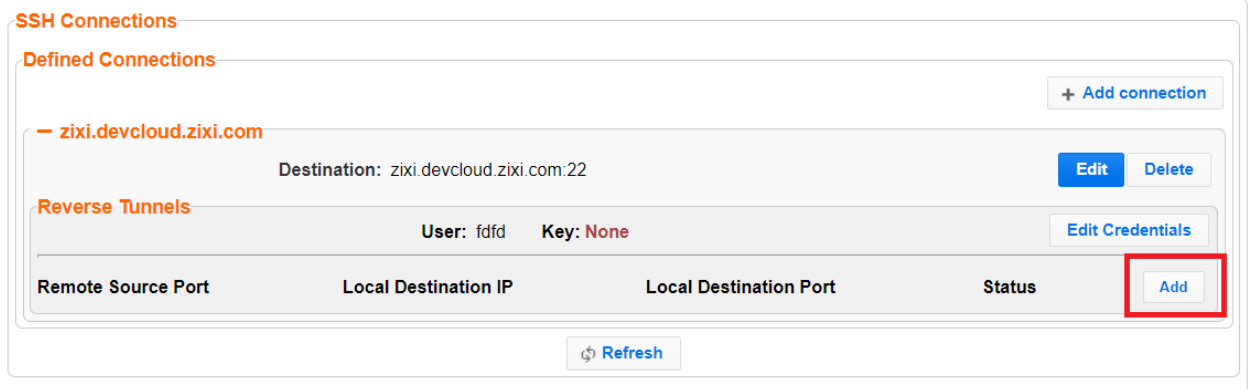

The screenshot displays the SSH Connections management interface. It features a 'Defined Connections' section with a single entry for 'zixi.devcloud.zixi.com' showing its destination as 'zixi.devcloud.zixi.com:22'. Below this is a 'Reverse Tunnels' section with a table for managing tunnels. The table has columns for 'Remote Source Port', 'Local Destination IP', 'Local Destination Port', and 'Status'. An 'Add' button is highlighted with a red box in the bottom right corner of the table. Other interface elements include an 'Add connection' button, 'Edit' and 'Delete' buttons for the defined connection, 'Edit Credentials' for the tunnel, and a 'Refresh' button at the bottom.

Remote Source Port	Local Destination IP	Local Destination Port	Status

The **Tunnel details** dialog appears.

6. In the **Remote Source Port** field, enter the port number of the remote server.
7. In the **Local Destination IP** field, enter the IP address of the local server.
8. In the **Local Destination Port** field, enter the port number to connect the tunnel.
9. Click **OK**.
10. Repeat steps 5-9 to add additional tunnels.

Authorization

Authorization can be configured for any incoming or outgoing streams.

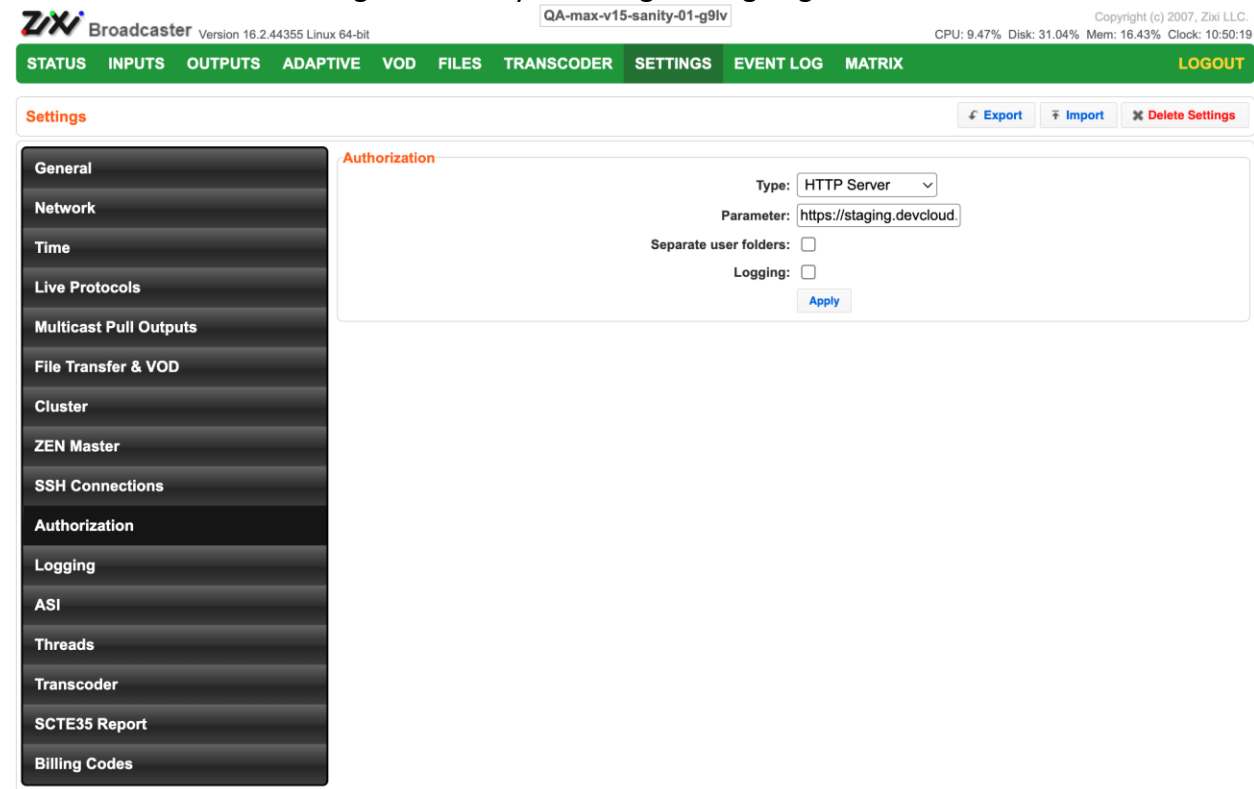

Field	Description
Authorization	
Type	<p>None (default) – authorization will be defined in the Input and Output streams. In this case you will need to define the password in the Input and the Output streams. Unless you select the Allow automatic push inputs and/or Allow automatic pull outputs checkboxes (as described below).</p> <p>Linux Users – uses the built-in authorization of the Linux operating system.</p> <p>Users File –</p> <p>Text File – this option manages authorizations in a text file. This option is useful for large OTT operations, as it does not require configuration for every user. The text file contains pairs of stream name and password that are used for the input streams. For the outputs, it contains the stream name, user and password of the viewer.</p> <p>Global Password – a single password that will be used for all access requests.</p> <p>Stream access – access authorization on the stream level. The password needs to be the same as the password to access the stream.</p> <p>Redirector auth –</p>

Server Settings

Authorization

Windows Users – uses the built-in authorization of the Windows operating system.

Other override authorization techniques are available. For more information contact Zixi support

HTTP Server – Zixi Broadcaster will generate an HTTP request to an external server on every connection.

Parameter

Specify the password that you would like to use for access.

HTTP Server – the URL of the external server to which the HTTP request is sent.

Allow Automatic Push inputs

If this checkbox is selected, the Zixi Broadcaster will automatically create an input stream each time it receives a push stream from a source.

However, if this checkbox is not selected, only predefined Push Input streams with the defined credentials will be allowed in (this is the default setting and the behavior in previous versions).

Default: not selected.

Allow Automatic pull outputs

If this checkbox is selected, any Zixi Receiver that requests a Pull output will be granted access. In this case, a Pull output will be automatically created in the Zixi Broadcaster (this is the default setting and the behavior in previous versions).

However, if this checkbox is not selected, only predefined Pull output streams with the defined credentials will be pulled by the Zixi Receiver.

Default: selected.

Separate user folders

Select this checkbox to enable access by user folders

Logging

Select the checkbox to enable logging of the connections

Logging

The Logging screen defines the logs location and preferences for debugging purposes.

Zixi Broadcaster Version 16.2.44355 Linux 64-bit QA-max-v15-sanity-01-g9lv Copyright (c) 2007, Zixi LLC. CPU: 5.73% Disk: 31.04% Mem: 16.44% Clock: 11:05:10

STATUS INPUTS OUTPUTS ADAPTIVE VOD FILES TRANSCODER **SETTINGS** EVENT LOG MATRIX LOGOUT

Settings Export Import Delete Settings

- General
- Network
- Time
- Live Protocols
- Multicast Pull Outputs
- File Transfer & VOD
- Cluster
- ZEN Master
- SSH Connections
- Authorization
- Logging**
- ASI
- Threads
- Transcoder
- SCTE35 Report
- Billing Codes

Logging

General level:

Path:

Max log files:

Max log file size [MB]:

Send crash reports:

Field	Description
Logging	
General Level	The Severity Level that will be collected in the log, from Info, Warning, Error, to Fatal. Selection of lower severity levels will include all higher-level logs. Default: None, since Logging is resource-intensive and only enabled when necessary.
Path	The log file name and path where the collected event information will be stored.
Max log files	The maximal number of log files.
Max log file size (MB)	The maximal size of each log file.
Send crash reports	Select the checkbox to send a crash report to Zixi Support.

Server Settings

ASI

ASI

The ASI screen is used to configure the ASI interface when there is an ASI card in the machine. You can use this screen to reverse the direction of the ports on the ASI card. The port numbers should correspond to the port numbers on your ASI card.

ASI Settings

Available ports

#	Name	Data direction	
1	Port 1	Input	→ Reset to output
2	Port 2	Input	→ Reset to output
3	Port 3	Output	← Reset to input
4	Port 4	Output	← Reset to input

ASI output stuffing:

ASI output PLL:

ASI fix time:

Initial buffer time[ms]:

Read buffer size[B]:

[Apply](#)

Field	Description
ASI output stuffing	Select this checkbox to achieve CBR (constant bitrate) by padding the ASI stream with TS null packets.
ASI output PLL	Select this checkbox to enable a phase-locked loop. A phase-locked loop or phase lock loop (PLL) is a control system that generates an output signal whose phase is related to the phase of an input signal. When selecting this option, the system will adjust the bitrate that is sent according to the fullness rate of the output buffer.
ASI fix time	Select this checkbox to adjust input timestamps to local machine time.
Initial buffer time [ms]	To avoid underflows, specify the output buffer size that will be filled before starting the transmission.
Read buffer size [B]	Specify the input read buffer to fill, before passing data to the application. Larger buffer size should be specified for higher bitrates; Smaller buffer size will be more responsive and smoother in lower bitrate streams.

ASI

Reversing the directions of the ports

➔ **To Reverse the Direction of the Ports:**

1. From the **Settings** page of the Zixi Broadcaster, click **ASI** on the left-hand side. The various **ASI settings** are displayed.
2. Click the desired RESET button to the right of the port that you want to reverse. A confirmation window is displayed with the notification that the service must first be restarted before the direction is reversed.

Field	Description
Available ports	
Name	Displays the port number used by the ASI protocol.
Data Direction	Displays the direction of the data being transmitted by the ASI protocol.

Threads

The Threads screen enables the configuration of the maximal number of concurrent CPU threads allowed for each component/service. Enter -1 to limit the threads according to the number of cores.

QA-max-v15-sanity-01-g9lv
 Copyright (c) 2007, Zixi LLC.
 CPU: 9.6% Disk: 31.04% Mem: 17.79% Clock: 11:17:48

STATUS INPUTS OUTPUTS ADAPTIVE VOD FILES TRANSCODER **SETTINGS** EVENT LOG MATRIX LOGOUT

Settings [Export](#) [Import](#) [Delete Settings](#)

Threads settings

Input:
 Output:
 VOD:
 Read:
 RTMP:
 UDP In:
 UDP Out:
 HTTP In:
 Transcoder:
 Push Output Receive:
 HTTP:
 Authorization:
 Analyzer:
 Adaptive:
 Various inputs:
 Accept:

a fraction means proportion of the number of cores, -1 means number of cores.

Field	Description
Input	Maximal number of threads for all input streams.
Output	Maximal number of threads for all output streams.
VOD	Maximal number of threads for all VOD streams.
Read	
Pool	
RTMP	Maximal number of threads for RTMP streams.
UDP In	Maximal number of threads for UDP input streams.
UDP Out	Maximal number of threads for Curl
HTTP In	

Server Settings

SNMP (Linux Only) (Deprecated)

Transcoder	Maximal number of threads for transcoding.
Push Output Receive	
HTTP	Maximal number of threads for the HTTP server.
Authorization	Maximal number of threads for the authorization component.
Analyzer	Maximal number of threads for the analyzer component.
Adaptive	
Various Inputs	
Accept	

SNMP (Linux Only) (Deprecated)



SNMP for monitoring and control of the Zixi Broadcaster is no longer supported. Monitoring and control of Zixi Broadcasters should be implemented using the ZEN Master API and Kafka data pipelines available via ZEN Master.

The SNMP screen includes basic configuration parameters for the configuration of Simple Network Management Protocol, which enables monitoring and control of Zixi Broadcaster by a monitoring system. For further information on how to enable and configure SNMP on Zixi Broadcaster, see **Configuring SNMP** section.

Server Settings

SNMP (Linux Only) (Deprecated)

Settings
Export Import Delete Settings

- General
- Network
- Time
- SNMP
- Live Protocols
- Multicast Pool
- File Transfer & VOD
- Cluster
- SSH Connections
- Authorization
- Logging
- ASI

Service: On

Root MIB
Broadcaster MIB

Read only community name:

Read-write community name:

SNMPv3 Users

User	Write access
+	

Trap receivers

Host	Port
10.7.0.23	162
+ <input type="text"/> <input type="text"/>	

Field	Description
Service	Click the button to Start/Stop the SNMP service.
Read-only Community Name	Used in SNMPv1 and SNMPv2, this parameter is used to specify the Community Name to enable read-only access to the Zixi Broadcaster monitored information. If the community string is correct, Zixi Broadcaster will respond with the requested information. If the community string is incorrect, Zixi Broadcaster will simply ignore the request and will not respond.
Read-write Community Name	Used in SNMPv1 and SNMPv2, this parameter is used to specify the Community Name to enable read-write access to Zixi Broadcaster. Read-write objects include, for example, zbiActive, which indicates and/or sets the Active state of an Input stream.
SNMP V3 Users	<p>For SNMPv3 monitoring systems, click the + button to add authentication credentials and fill-in the following fields:</p> <ul style="list-style-type: none"> User name - enter the SNMP user name Write access - select the checkbox to allow Read-Write access rights. If the checkbox is not selected, the user will have Read-only access rights. Password - enter the SNMP user's password.
Trap Receivers	<p>Specify SNMP Trap receivers that will listen to the SNMP Traps that will be sent by Zixi Broadcaster. Click the + button to add authentication credentials of the Trap Receiver, by filling-in the following fields:</p> <ul style="list-style-type: none"> Community - Specify the community name for access. Host - Specify the IP address to which the Trap messages will be transmitted.

273 | Zixi Broadcaster

DOC16-83-0039

Server Settings

Transcoder

- Port - Specify the Port number to which the Trap messages will be sent transmitted.

Transcoder

The Transcoder settings screen enables configuration of the Transcoder settings.

Enabling PSNR in x264

➔ To Enable PSNR in x264:

1. In the **Settings** page, click **Transcoder**.
2. Select the **Enable PSNR in x264** checkbox.



The screenshot shows a form titled "Transcoder settings" with a red border. Inside the form, the checkbox "Enable PSNR in x264:" is checked. Below the checkbox is an "Apply" button.

3. Click **Apply**.

SCTE35 Report

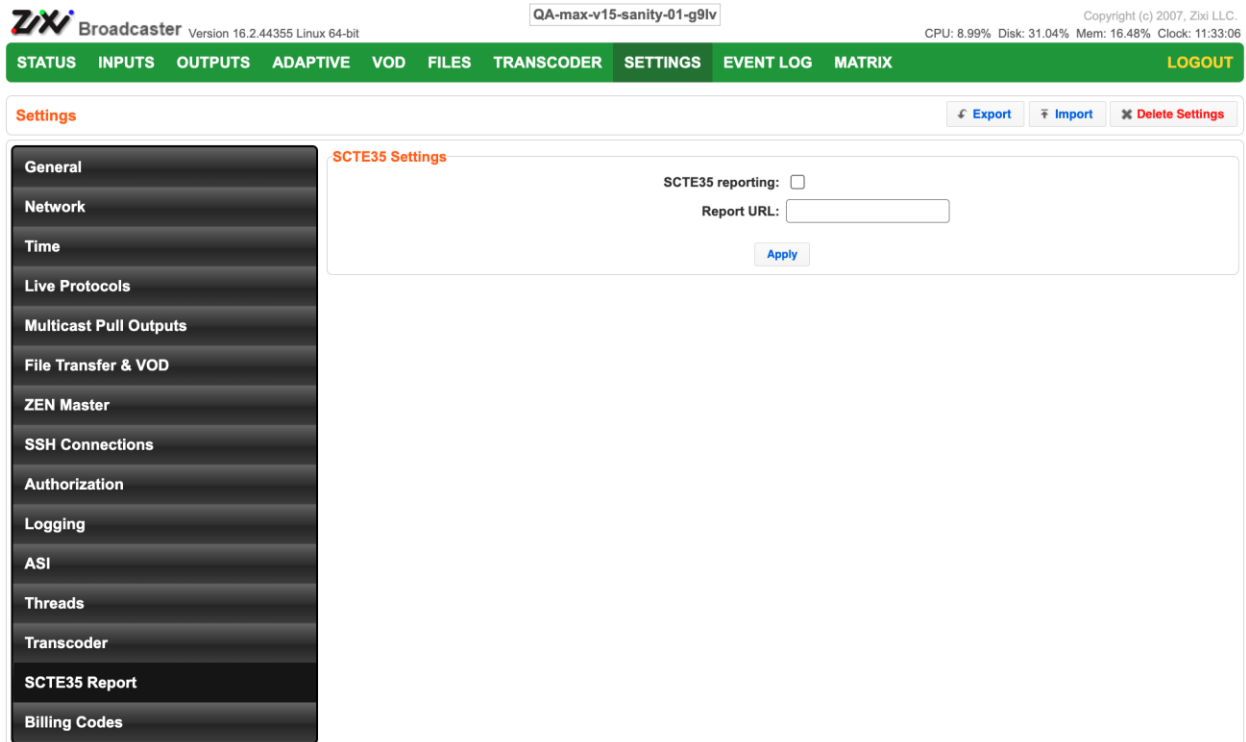

The screenshot shows the Zix Broadcaster Settings page. The top navigation bar includes STATUS, INPUTS, OUTPUTS, ADAPTIVE, VOD, FILES, TRANSCODER, SETTINGS, EVENT LOG, MATRIX, and LOGOUT. The main content area is titled "Settings" and includes a sidebar with various settings categories. The "SCTE35 Settings" section is highlighted, showing the "SCTE35 reporting:" checkbox (unchecked) and the "Report URL:" text input field. An "Apply" button is located below the input field.

Field	Description
-------	-------------

Server Settings

SCTE35 Report

SCTE35 reporting

Report URL

Billing Codes

The Billing Codes settings screen enables you to specify Billing Codes that will automatically add billing codes to inputs and/or outputs.

Field	Description
Automatic inputs billing code	
Billing code password	
Automatic outputs billing code	
Billing code password	

Viewing Events Log

The Event Log screen displays all the events (errors, connections, configuration changes, analysis events etc.) that occurred in the Zixi broadcaster. The logs are displayed in the server time (not local time) and can be exported as a .csv or .txt file.

In Linux, the event log is written to a file located in the following location on the disk:

/log/var/messages

➔ To Clear the Log:

In the **Event Log** screen, click **Clear** on the upper right-hand corner.

The events on the log screen are deleted.

➔ To Save the Log as a .csv File:

In the **Event Log** screen, click **Save** on the upper right-hand corner.

A .csv file is created and saved to the local destination.

➔ To Save the Log as a .txt File

In the **Event Log** screen, click **System Log** on the upper right-hand corner.

A .txt file is created and saved to the local destination.

➔ To Refresh the Screen:

In the **Event Log** screen, click **Refresh** on the upper right-hand corner.

The data on the screen is updated.

Using the Matrix

The Zixi Matrix view provides a visual-based alternative to managing the streams, by previewing the input and output streams with their current status. Matrix offers drag and drop capabilities to connect input streams to outputs as well as some of the actions that were covered in the Performing Actions on Input Streams and Performing Actions on Output Streams sections above.

The following formats are supported in the Matrix:

- Video:
 - MPEG 1/2, 8bit 4:2:0 , interlaced/progressive, up to 60fps, up to Full HD (1080p)
 - H.264/AVC, 8/10 bit, 4:2:0, 4:2:2, 4:4:4, interlaced/progressive, up to 60fps, up to 4k (2160p)
 - H.265/HEVC, 8/10 bit, 4:2:0, 4:2:2, 4:4:4, interlaced/progressive, up to 60fps, up to 4k (2160p)
 - JPEG2000, 8/10 bit, 4:2:0, 4:2:2, interlaced/progressive, up to 60fps, up to 4k (2160p)
- Audio (for audio levels meter overlay):
 - AAC (LC, HEV1, HEV2)
 - AC3 (downmix to stereo)
 - Opus
 - MPEG1/2 Layer 1/2/3

Connecting Input to Output

An easier method of connecting inputs to outputs.

➔ To Connect an Input to an Output:

Drag the desired input thumbnail and drop it over a specific output thumbnail.

The desired input is connected to the selected output.

Disconnecting Output from Input

➔ To Disconnect an Input from an Output:

1. Click on the connected stream that you want to disconnect.
The **Input stream data** window is displayed.
2. Click **Unlink**. A confirmation window is displayed.
3. Click **Confirm**. The Output is disconnected from the Input.

Matrix Interface Elements

The Matrix view displays preview thumbnails of the Input and Output streams. Preview thumbnails of input streams are presented in the Inputs pane and preview thumbnails of output streams are presented in the Outputs pane.

- If the stream is active - the live video will be shown in the preview thumbnail.
- If an input stream is not active – the preview thumbnail will include an “Offline” message.
- If an output stream has been created, but has not been connected to an input – the preview thumbnail will include the following message - “Drag Input Here”.
- If a connected output stream does not receive a live stream - the preview thumbnail will include a “No Video” message.

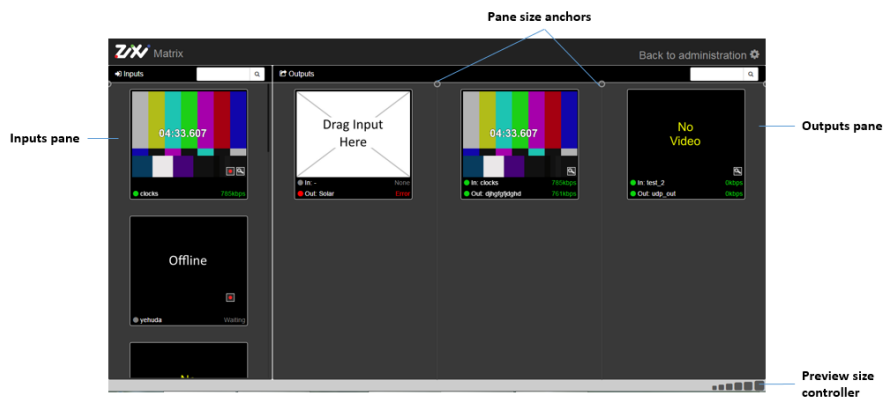

Changing Matrix View

You can modify the size of the panes, the size of the preview thumbnails, and re-arrange the order the preview thumbnails.

➔ To modify the size of the panes:

Click on one of the rounded **pane size anchors** (see screenshot above)

➔ To modify the size of the preview thumbnails:

Click on one of the sizes in the **preview size controller** (see screenshot above).

➔ To re-arrange the order the preview thumbnails:

Drag and drop the preview thumbnail to the desired position within the pane.

Searching for Specific Streams

➔ To Search for a Specific Stream:

1. Type in the specific stream name in the appropriate (Input or Output) search text box on the top of the console and click .
2. The relevant stream will be the only one to be displayed in the pane.

Preview Thumbnail Elements

The following stream formats are supported for thumbnail preview:

- Scan Style: Interlaced and Progressive
- Codec: MPEG2, H.264/AVC
- Frame Size: SD, HD (720p), Full HD (1080p), 4K (2160p)
- Frame Rate: 24fps, 25fps, 29.97fps, 30fps, 59.94fps, 60fps
- Chroma Subsampling: 4:2:0
- Bit Depth: 8-bit (MPEG2, H.264/AVC), 10-bit (H.264/AVC)

Using the Matrix

Preview Thumbnail Elements

The preview thumbnail includes the following elements:

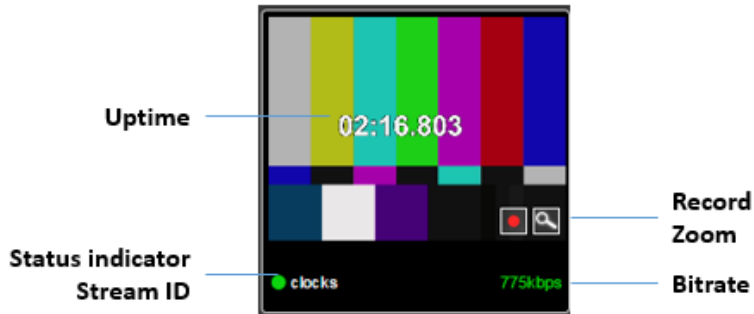

Element	Description	Action
Status Indicator	Displays the unique identifier for this group.	
Stream ID	Displays the unique name for the stream.	
Bitrate [kbps]	Displays the bitrate of the active stream.	
Uptime	Displays the amount of time the stream has been active.	
Record	Stream recording	Click the record button to start recording. Click again to stop recording
Zoom	Opens the stream in a larger preview window with sound	Click the Zoom icon to open the larger preview screen.

Viewing Stream Details

➔ To View Stream Details:

Click anywhere on the preview thumbnail.

The Stream Details window opens:

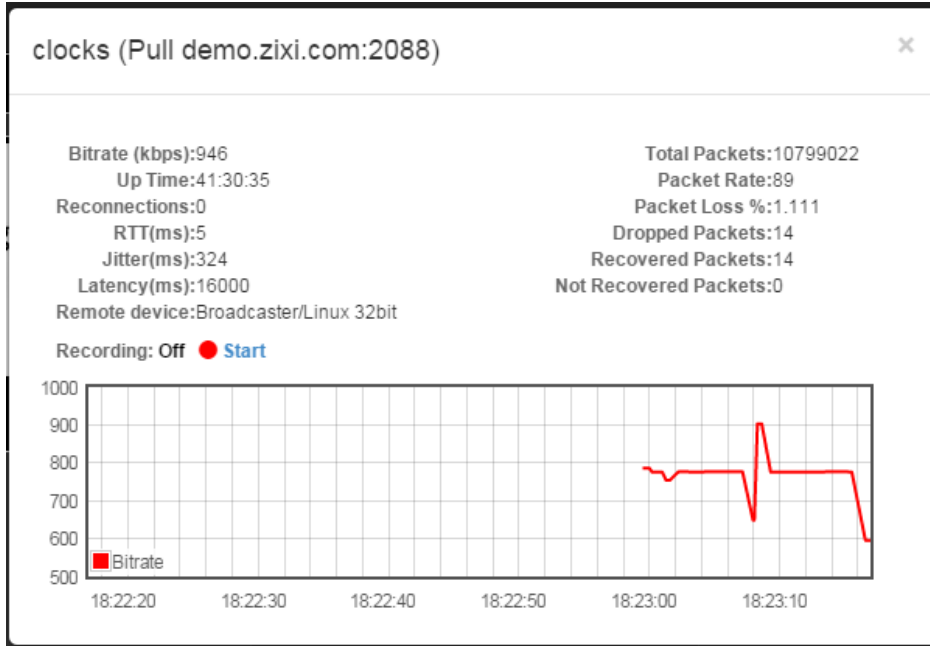

Configuring SNMP (Deprecated)



SNMP for monitoring and control of the Zixi Broadcaster is no longer supported. Monitoring and control of Zixi Broadcasters should be implemented using the ZEN Master API and Kafka data pipelines available via ZEN Master.

Zixi Broadcaster enables monitoring and control via SNMP (on Linux only). The monitoring system can receive SNMP Trap messages from Zixi Broadcaster as well as access monitored objects with read-only and read-write access privileges (objects and their access permissions are defined in the MIB). Zixi Broadcaster supports SNMPv1, SNMPv2, and SNMPv3. Before using SNMP you need to ensure that SNMP is enabled in your Zixi Broadcaster license, run a script, as described below, and configure the SNMP settings in the Settings >SNMP screen.



The SNMP feature is not enabled by default. If you do not see this screen, please contact Zixi Support.

Activating SNMP

➔ To Activate SNMP:

Run the script file `./install_snmp.sh`, located in the Broadcaster folder, where Zixi Broadcaster was installed. The events on the log screen are deleted.



Note: Running the script may cause Zixi Broadcaster to restart.

Configuring SNMP Settings

Configuring SNMP (Deprecated)

Configuring SNMP Settings

➔ To configure SNMP:

1. In Zixi Broadcaster UI, go to **Settings > SNMP**.

The screenshot shows the 'Settings' page for SNMP configuration. On the left is a navigation menu with options: General, Network, Time, SNMP (highlighted), Live Protocols, Multicast Pool, File Transfer & VOD, Cluster, SSH Connections, Authorization, Logging, and ASI. The main content area has a 'Service' dropdown set to 'On'. Below it are two text input fields for 'Read only community name' and 'Read-write community name'. There is a section for 'SNMPv3 Users' with a '+' button to add users. Below that is a 'Trap receivers' section with a table:

Host	Port
10.7.0.23	162

Buttons for 'Export', 'Import', and 'Delete Settings' are at the top right. An 'Apply' button is at the bottom of the main content area.

2. In the **Service** field, click the button to activate the service.

3. Do one of the following:

- For SNMPv1 or SNMPv2, fill in the read-only and/or read-write community name in the **Read only community name**, and **Read-write community name** fields.
- For **SNMPv3**, under the SNMPv3 Users section, click the + button.

The following screen appears:

The dialog box is titled 'SNMPv3 user details' and contains the following fields:

- User name:** A text input field.
- Write access:** A checkbox.
- Password:** A text input field.

At the bottom are 'Apply' and 'Close' buttons.

- In the **User Name** field, enter the SNMP user name.
 - In the **Write Access** field, select the checkbox to allow **Read-Write** access rights. If the checkbox is not selected, the user will have **Read-only** access rights.
 - In the **Password** field, enter the SNMP user's password.
4. Under the **Trap Receivers** section, specify SNMP Trap receivers that will listen to the SNMP Traps that will be sent by Zixi Broadcaster, by clicking the + button to add a trap receiver.

Configuring SNMP (Deprecated)

Configuring SNMP Settings

The following screen appears:

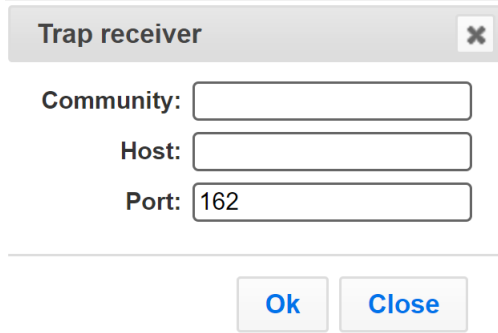

Trap receiver

Community:

Host:

Port:

Ok Close

5. In the **Community** field, specify the community name for access.
6. In the **Host** field, specify the IP address to which the Trap messages will be transmitted.
7. In the **Port** field, specify the Port number to which the Trap messages will be sent transmitted.
8. Click **Apply**.

Viewing MIB Information

You can view the "Root MIB" (which defines the Zixi Broadcaster tree root definitions) and the "Broadcaster MIB" (which describes the Zixi Broadcaster MIB tree definition, including all its objects).

➔ To view MIB information:

1. In Zixi Broadcaster UI, go to **Settings > SNMP**.
2. At the upper right-hand corner click the **Root MIB** and/or **Broadcaster MIB** links.

The screenshot shows the 'Settings' page for SNMP configuration. On the left is a navigation menu with 'SNMP' selected. The main area contains the following configuration options:

- Service: On
- Read only community name: [Redacted]
- Read-write community name: [Redacted]
- SNMPv3 Users table:

User	Write access
	[+]
- Trap receivers table:

Host	Port
10.7.0.23	162
	[+]

An 'Apply' button is located at the bottom of the configuration area. In the top right corner, there are links for 'Root MIB' and 'Broadcaster MIB', which are highlighted with a red box in the image.

SNMP Alerts/Notifications

The SNMP traps are sent when an alert is raised and when alert is cleared on following occasions:

- Input stream alerts (zbtInputStreamAlertRaised = .1.3.6.1.4.1.38369.1.1.1.0.58; zbtInputStreamAlertCleared = .1.3.6.1.4.1.38369.1.1.1.0.60)
Important parameters:
\$ zbsProgramID (Id of the broadcaster that sends the trap, .1.3.6.1.4.1.38369.1.1.1.1.2)
\$ zbtStreamID (Id of the stream, .1.3.6.1.4.1.38369.1.1.1.0.2)
\$ zbtStreamAlertType (alert type, .1.3.6.1.4.1.38369.1.1.1.0.10)
- TR101 analyser alerts (zbtTR101AlertRaised = .1.3.6.1.4.1.38369.1.1.1.0.90; zbtTR101AlertCleared = .1.3.6.1.4.1.38369.1.1.1.0.91)
Important parameters:
\$ zbsProgramID (Id of the broadcaster that sends the trap, .1.3.6.1.4.1.38369.1.1.1.1.2)

Configuring SNMP (Deprecated)

SNMP Alerts/Notifications

- \$ zbtStreamID (Id of the stream, .1.3.6.1.4.1.38369.1.1.1.0.2)
- \$ zbtTR101AlertErrorCode (TR101 alert code, .1.3.6.1.4.1.38369.1.1.1.0.30)
- Output stream alerts (zbtOutputStreamAlertRaised = .1.3.6.1.4.1.38369.1.1.1.0.59; zbtOutputStreamAlertCleared = .1.3.6.1.4.1.38369.1.1.1.0.61)
- \$ zbsProgramID (Id of the broadcaster that sends the trap, .1.3.6.1.4.1.38369.1.1.1.1.2)
- \$ zbtStreamID (Id of the input stream where output is assigned, .1.3.6.1.4.1.38369.1.1.1.0.2)
- \$ zbtOutputID (Id of the output, .1.3.6.1.4.1.38369.1.1.1.0.3)
- \$ zbtStreamAlertType (alert type, .1.3.6.1.4.1.38369.1.1.1.0.10)
- Performance alerts (zbtPerformanceAlertRaised = .1.3.6.1.4.1.38369.1.1.1.0.80; zbtPerformanceAlertCleared = .1.3.6.1.4.1.38369.1.1.1.0.81)

Important parameters:

- \$ zbsProgramID (Id of the broadcaster that sends the trap, .1.3.6.1.4.1.38369.1.1.1.1.2)
- \$ zbtPerformanceAlertType (alert type, .1.3.6.1.4.1.38369.1.1.1.0.20).

In addition, traps are sent on following events:

- Input stream created (zbtInputStreamCreated = .1.3.6.1.4.1.38369.1.1.1.0.54)
- Output stream created (zbtOutputStreamCreated = .1.3.6.1.4.1.38369.1.1.1.0.55)
- Input stream up (zbtInputStreamUp = .1.3.6.1.4.1.38369.1.1.1.0.50)
- Input stream down (zbtInputStreamDown = .1.3.6.1.4.1.38369.1.1.1.0.50)
- Output stream up (zbtOutputStreamUp = .1.3.6.1.4.1.38369.1.1.1.0.51)
- Output stream down (zbtOutputStreamDown = .1.3.6.1.4.1.38369.1.1.1.0.53)
- Input stream deleted (zbtInputStreamDeleted = .1.3.6.1.4.1.38369.1.1.1.0.56)
- Output stream deleted (zbtOutputStreamDeleted = .1.3.6.1.4.1.38369.1.1.1.0.57)
- Successful broadcaster process start (zbtProgramStartSuccess = .1.3.6.1.4.1.38369.1.1.1.0.200)
- Failure to start broadcaster process (zbtProgramStartFailed = .1.3.6.1.4.1.38369.1.1.1.0.201)

Important parameters:

- \$ zbsProgramID (Id of the broadcaster that sends the trap, .1.3.6.1.4.1.38369.1.1.1.1.2)
- \$ zbtStreamID (Id of the input stream, .1.3.6.1.4.1.38369.1.1.1.0.2) applicable for inputs' and outputs' events.
- \$ zbtOutputID (Id of the output, .1.3.6.1.4.1.38369.1.1.1.0.3), applicable only for outputs' events.

Configuring Hitless Failover

Zixi features hitless failover for inputs, enabling uninterrupted streaming when switching from one source to another. The hitless failover feature is based on the SMPTE 2022-7 standard, which specifies “seamless” or hitless failover between binary-identical streams with synchronized RTP headers. Zixi's patent-pending hitless failover technology works by comparing the transport stream payload, without relying on sequences being synchronized. Zixi then applies a proprietary sequencing algorithm to identify missing parts and fill-in missing packets.

The Hitless Failover feature is supported in the inputs of Zixi Feeder, Broadcaster, and Receiver.

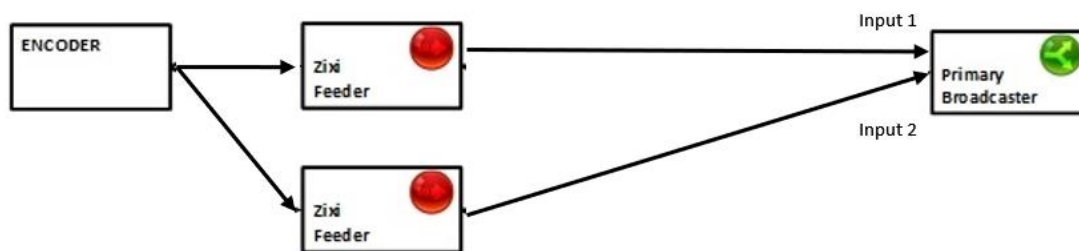

The hitless failover configuration involves grouping two inputs in a "Failover Group". The failover group includes the following configuration options for the merging of binary-identical streams:

The merging of the streams can be achieved using one of the following methods:

- **RTP headers (SMPTE 2022-7)** – if the sources are RTP and the RTP headers were maintained, Zixi will use the SMPTE 2022-7 to compare and merge the two streams in order to allow hitless failover. This option is the most recommended as it will use the sequence and the timestamp in the packets to compare which packets are missing. This method is more accurate than methods that compare the entire payload or methods that use sophisticated DNA sequencing algorithm, which are more error prone, as the payload may have multiple matches.
- **RTP headers or TS content** – if the sources do not have RTP headers, Zixi will try to merge using the MPEG-TS content itself.

In these cases, when one of the streams is disrupted or interrupted completely, Zixi Broadcaster will seamlessly use the packets of the other input without any disruptions.



If the streams are not identical, the failover process will not be seamless and may take up to a second.

A Failover Group can comprise two or more inputs. In a group of three or more, you can define one or more streams as a "Backup". In this case the system will always try to recover packets from "Primary" streams first and only if there are no available primary streams, it will use the backup

Configuring Hitless Failover

SNMP Alerts/Notifications

streams. When one of the primary streams becomes available, the system will automatically jump to the primary stream.

While the Broadcaster GUI only enables configuration of primary streams at a single priority level, through the Zixi Broadcaster API it is possible to assign different priorities as follows:

- Priority 0 – means backup. It will be used only if all other streams are unavailable.
- Priority greater than 0 - means primary.

The Failover Group has its own Stream ID, just like an Input Stream, and will appear in the Inputs list. Although the topology above shows only one Zixi Broadcaster, it is also possible to have multiple targets (e.g. two or more Zixi Broadcasters), each with its own Failover Group of inputs to enable a more complete system-level redundancy.

To configure a Failover Group, follow the instructions in the [Creating a Failover Group](#) section.

Configuring HTTPS

Zixi Broadcaster supports HTTPS encryption based on OpenSSL. Zixi Broadcaster expects certificate files in X.509 textual format (sometimes called 'pem') with a full chain of certificates, each one starts with "-----BEGIN CERTIFICATE-----", and the associated private key file, that starts with "-----BEGIN PRIVATE KEY-----". The certificate can be provided by an SSL/TLS certificate provider (Certification Authority) where the domain is registered, such as VeriSign, Digicert, etc.. Alternatively, the certificate can be self-signed. A self-signed certificate is a certificate that is signed with its own private key. Self-signed certificates can be used to encrypt data just as well as CA-signed certificates, but your users will be displayed a warning that says that the certificate is not trusted by their computer or browser. Therefore, self-signed certificates should only be used if you do not need to prove your service's identity to its users (e.g. non-production or non-public servers).

Obtaining a CA-signed Certificate

Reach out to the hosting provider for instructions on how to obtain a CA-signed HTTPS certificate. As part of this process, you will be required to generate a certificate signing request (CSR). A CSR consists mainly of the public key of a key pair, and some additional information. Both of these components are inserted into the certificate when it is signed. To learn more about generating a CSR, go to - <https://www.digitalocean.com/community/tutorials/openssl-essentials-working-with-ssl-certificates-private-keys-and-csrs>.

Creating a Self-signed Certificate

Instead of obtaining a CA-signed certificate, you can create a self-signed certificate.

You can generate self-signed x.509 certs with OpenSSL by using the following command:

```
openssl req -x509 -newkey rsa:2048 -keyout selfsigned_key.pem -out selfsigned_cert.pem
```

To learn more about generating a self-signed certificate, go to:

<https://www.digitalocean.com/community/tutorials/openssl-essentials-working-with-ssl-certificates-private-keys-and-csrs>.

Uploading the Certificate and Private Key

After obtaining a CA-signed certificate or creating a self-signed one, you will need to upload the certificate and private key to Zixi Broadcaster.

➔ To upload the certificate and private key:

1. In **Zixi Broadcaster UI**, go to **Settings > General**.
2. Click + to expand the HTTPS and DTLS Streaming Certificate section
3. In the **Certificate Uploaded** field, click **Upload** and select the certificate file.
4. In the **Private Key Uploaded** field, click **Upload** and select the Private Key.
5. In the **Private Key Passphrase** field, type the passphrase or leave empty (Default passphrase is empty, ignore the '****').
6. Click **Apply**.

If the process was successful, the **SSL setup status** field will turn to "OK".

Configuring NDI Streams

Network Device Interface (NDI) is a royalty-free software standard developed by NewTek to enable video-compatible products to communicate, deliver, and receive broadcast-quality video in a high-quality, low-latency manner that is frame-accurate and suitable for switching in a live production environment.

NDI was designed to deliver 1080i HD video at VBR data rates typically around 100 Mbit/s. Zixi Broadcaster uses an NDI library to read uncompressed frames from the NDI stream and pushes them to the Zixi Broadcaster's transcoder. The transcoder can then transcode the uncompressed stream into a transport stream using one of the available codecs, such as H.264 or H.265 video and AAC or Opus audio.

Zixi Broadcaster supports the following flows for NDI:

- **NDI Input** – the NDI source stream, which is uncompressed, is transcoded via the Zixi Broadcaster transcoder into any one of the available codecs. The transcoded stream will be available as an Input Stream when creating an Output in Zixi Broadcaster.
- **NDI Output** – Zixi Broadcaster can transcode a TS stream into an NDI output using Raw video and audio profiles. The NDI output is configured in the transcoding profile itself, so there is no need to create an NDI Output. When the input stream is transcoded, it becomes available to be pulled by NDI enabled devices.

A typical deployment involves ingesting NDI to a Zixi Broadcaster through LAN at one location and then using Zixi Broadcaster to compress the stream into high quality AVC/H.264 or HEVC/H.265. The stream is then delivered to another location over the public internet to any distance using the reliable, low latency Zixi protocol and then at the receiving location the stream is decoded by a Zixi Broadcaster and broadcasted on the local LAN as NDI again. While a single 1920×1080@30 fps NDI stream may require 125 Mbps of bandwidth on the local network, once it is compressed for delivery with Zixi it will only require 10 to 15Mbps using HEVC/H.265 and no perceptible quality loss, to move the stream over the public internet.

NDI Stream Discovery

NDI uses the mDNS (Bonjour / Zeroconf) discovery mechanism to create a zero-configuration environment for discovery of NDI streams available on the LAN. Through mDNS, devices such as the Zixi Broadcaster can discover available NDI streams for processing. The mDNS (Bonjour / Zeroconf) discovery mechanism should be installed as required according to the system's OS, as described in the OS Support section. This means that there are different requirements depending on the type deployment:

- **Using NDI within a local area network** – on a local area network NDI will use the discovery mechanism to advertise the sources and Zixi Broadcaster will automatically

Configuring NDI Streams

NDI Stream Discovery

discover these streams, while listing them in the **Stream** parameter of the NDI input stream.

- **Using NDI in the cloud** – to make the streams discoverable in the cloud, you need to deploy an NDI Discovery Server and configure the NDI plug-in with the settings included in the following example:

```
{
  "ndi": {
    "groups": {
      "recv": "\"public\"",
      "send": "\"public\""
    },
    "multicast": {
      "recv": {
        "enable": false,
        "subnets": ""
      },
      "send": {
        "enable": false,
        "netmask": "255.255.255.0",
        "netprefix": "239.192.136.100"
      }
    },
    "networks": {
      "discovery": "22.127.94.57",
      "ips": ""
    },
    "tcp": {
      "recv": {
        "enable": false
      },
      "send": {
        "enable": false
      }
    },
    "unicast": {
      "recv": {
        "enable": false
      },
      "send": {
        "enable": false
      }
    }
  }
}
```

OS Support

The use of mDNS requires operating system support as follows:

- **Windows** - Windows 10 has mDNS support built in, which is necessary for any NDI applications running on Windows.
- **CentOS 7** - The recommended platform for the Zixi Broadcaster is CentOS 7. mDNS support is provided by the Avahi package which typically is not installed by default on CentOS 7.

➔ **To install Avahi, run the following commands on the server hosting the Zixi Broadcaster:**

```
# sudo yum install avahi
# sudo service avahi-daemon start
```

Enabling Multicast Network Support

The mDNS Ethernet frame is a multicast UDP packet that broadcasts to:

- MAC address 01:00:5E:00:00:FB(for IPv4)
- IPv4 address 224.0.0.251
- UDP port 5353

You need to verify that the LAN where NDI streams are present is multicast enabled and that all systems needing access to NDI streams, such as the Zixi Broadcaster, do not block mDNS via their firewall.

NDI config file location

- On Windows: %PROGRAMDATA%\NewTek\NDI\ndi-config.v1.json
- On Linux: \$HOME/.newtek/ndi-config.v1.json



On Linux the NDI config files should be placed in the home directory of the user which Broadcaster is running as root. Thus, the file must be located at /root/.newtek/ndi-config.v1.json.

Specifying the NDI Discovery Server

➔ **To specify NDI Discovery Server:**

1. Open ndi-config.v1.json.
2. In the "networks" section, under "discovery" add the discovery server's IP, which is the address of a host where NDI Discovery Server is working. For example, if you have it working on 192.168.0.253, then your config will have this section:

```
"networks": {"ips": "", "discovery": "192.168.0.253"},
```

Configuring Transcoding Profiles for NDI Sources

Before creating the NDI Input in Zixi Broadcaster, you must configure at least one transcoding profile that meets the following requirements:

- **Disable Copy GOP from source** - NDI sources can be transcoded using any of the available transcoding profiles, however it is **NOT possible** to enable the **Copy GOP from source** feature. Since all frames in the original NDI source are uncompressed, Zixi cannot know which frames were i-frames in the stream, so the GOP length should be configured in the **GOP [frames]** parameter of the transcoding profile.
- **No Keep Original** - when configuring the stream, it is possible to remove the video or audio from the stream, however it is **NOT possible** to keep the original video or audio, as they are originally uncompressed.
- **No RAW Video/Audio** - transcoding profiles with **RAW Video** and/or **RAW Audio** will be filtered out and will not appear in the **Video profile/Audio Profile** fields on the NDI Input screen.

For detailed instructions on how to configure transcoding profiles, see [Transcoder](#) section.



Transcoding is not currently supported in ARM builds of Zixi Broadcaster.

Adding an NDI Input to Zixi Broadcaster

The NDI is pulled into Zixi Broadcaster using the auto-discovery mechanism described in the **NDI Stream Discovery** section.

➔ To Add an NDI Input Stream:



Before adding the NDI Input Stream, you must configure the relevant transcoding profiles – See **Configuring Transcoding Profiles for NDI Sources**.

1. In the Zixi Broadcaster Navigation menu, click the **Inputs** tab.
2. In the Menu bar, click **New Input**. The **Add new input stream** window is displayed.

Configuring NDI Streams

Adding an NDI Input to Zixi Broadcaster

3. Select **NDI** for the input stream.

The screenshot shows the 'Add new input stream' dialog box. At the top, there are radio buttons for different input protocols: Push, Pull, UDP, Delayed, File, RTMP, RTSP, HLS, TS over HTTP, SRT, SRT Client, RIST, NDI (selected), WebRTC, and File over HTTP. Below this, the 'Stream parameters' section includes a 'Stream' dropdown menu, 'Video profile' and 'Audio profile' dropdowns, 'Audio Reference Level [dB]' and 'Transport stream bitrate [kbps]' input fields, and checkboxes for 'Add RTP headers', 'Use Intel hardware acceleration (if available)', and 'Smoothing buffer [ms]'. There are also checkboxes for 'Enable time shift', 'Enable multicast on pull outputs', 'Enable encryption', and 'Recording parameters'. The dialog has 'Ok' and 'Cancel' buttons at the bottom right.

4. Select the maximum concurrent connections to this stream from the **Max. Outputs** drop-down list. Default: Unlimited.
5. Select the **Show in Matrix** check box to display this stream in the Matrix (see [Using the Matrix](#)). Default: Selected.
6. Specify the **Stream Parameters** (see Input Stream Parameter table).
7. If you want to **Enable time shift**, select this checkbox (see Input Stream Parameter table). The stream will be recorded and broadcasted after the specified delay. The time shift feature is typically used to broadcast a live event across time zones (due to the time differences between locations).
8. If you want to **Enable multicast on pull outputs**, select this checkbox (see Input Stream Parameter table).
9. If you want to **Enable encryption**, select this checkbox (see Input Stream Parameters Table). For more information, see [Encrypting an Input Stream in Zixi Broadcaster](#).
10. If you want to configure the **Recording Parameters**, specify them in the respective fields (see Input Stream Parameter table).
11. Click **OK**. The “Input added” message appears on the top of the screen. The NDI Stream is added to the Zixi Broadcaster and now appears in the list of streams available in Zixi Broadcaster Inputs screen.

Configuring NDI Streams

Adding an NDI Input to Zixi Broadcaster

Input Stream Parameters table

Parameter	Description
Stream Parameters	
Stream	Select one of the NDI streams available based on your configuration from the drop-down menu. On a local area network NDI will use the discovery mechanism to advertise the sources and Zixi Broadcaster will automatically discover these streams. To make the streams discoverable in the cloud, you need to deploy an NDI Discovery Server and configure the NDI plug-in with the settings mentioned above.
Video Profile	Select an existing transcoding video profile, or select Remove stream if you want to remove the video track.
Audio Profile	Select an existing transcoding audio profile, or select Remove stream if you want to remove the audio track.
Audio Reference Level [dB]	This parameter attenuates the audio level by the specified level in dB. This setting is used to prevent audio clipping.
Transport Stream Bitrate [kbps]	Specify the bitrate of the transport stream. This parameter is optional. If you do not specify a TS Bitrate, the stream will be VBR. If you specify a bitrate, the stream will be CBR. The bitrate value must be compatible with the selected profile.
Add RTP headers	<p>Select this checkbox to add RTP headers to the stream. RTP adds a 12-byte header, which includes a sequence number and a timestamp that can be used to detect dropped packets. The sequence number in the RTP headers can be used to do automatic reordering and the timestamps can help overcome inter-packet gaps, also known as IAT (Inter Arrival Time).</p> <p>However, plain RTP does not feature error recovery or error protection. By default, the RTP headers (which include the timestamps and sequences) are being used on the input side, but then they are stripped off and they no longer propagate to outputs.</p>
Use Intel hardware acceleration (if available)	Select this checkbox to use the Intel hardware acceleration component if it available.
Smoothing buffer	The Smoothing feature uses a buffer to time packets according to the stream's clock. This is useful when there are bursts in the rate in which the stream arrives. The smoothing features creates a queue in the buffer, allowing smoother entry into the Broadcaster. The Smoothing parameter defines the size of the buffer in Milliseconds. A larger the buffer enables smoother entry. However, it may influence the latency rate.

Configuring NDI Streams

Adding an NDI Input to Zixi Broadcaster

Enable time shift Select this checkbox to record the stream content and broadcast it after a specified delay. To deploy an input stream that uses the current stream's time shift, you need to configure a "Delayed" input stream. (See [Adding Delayed Streams](#)).

Maximum delay [hh:mm:ss] (for Time Shift enabled) Specify the time of a delayed transmission of this stream. Maximum: 24 hours

Enable multicast on pull outputs Select this checkbox to enable the transmission of this stream's outputs as multicast. A Zixi Broadcaster that will pull the stream will receive it in multicast. By default Zixi Broadcaster is configured to allow transparent fallback to unicast if it is out of the LAN. Requires enabling **Multicast Pull** in the **Settings**.



This setting can be modified without interrupting an existing stream.

Multicast-Only (for multicast enabled) If desired, specify multicast-only outputs.

Enable Encryption Select this checkbox to encrypt the Input stream. For more information, see [Encrypting an Input Stream in Zixi Broadcaster](#).

Encryption type (for Encryption enabled) Specify the type of Encryption (AES 128/192/256).

Encryption key (for Encryption enabled) Click **Generate** to generate an encryption key. The generated encryption key must be sent to the end-user to decipher the received encoded stream.

Recording parameters Select this checkbox to customize the recording parameters.

Destination Type Select the radio button for the desired storage type and then fill in the relevant parameters.

- **Record to disk** – the recording is saved on the local disk.
 - **Record to S3** – the file is saved to your AWS S3 Bucket.
-
-

Record to Disk Parameters

Configuring NDI Streams

Adding an NDI Input to Zixi Broadcaster

File Name Template	<p>Specify the file name pattern that Zixi will use to generate when saving the recorded content. A separate file will be generated for each recording up to the time specified in the Max recorded file duration parameter (see above). After this duration a new file will be generated.</p> <p>The file name pattern can include any string and up to five variables listed below. Only the %T=HH.MM.SS creation time is mandatory. You can change the order of these variables and add text as long as you maintain the legitimate structure of the file in Linux and Windows:</p> <ul style="list-style-type: none">• %S=stream id - optional.• %Y=year - optional• %M=month - optional• %D=day - optional• %T=HH.MM.SS creation time – mandatory• %U=YYYYmmddTHHMMSSZ UTC timestamp – optional <p>For example, the following pattern %Y_recording%T.ts will generate the following file name 2017_recording15:32:35.ts.</p>
Max recorded file duration [hours]	Specify the maximum time allotted for recording a video stream. Default: 2 hours
Keep recorded files for [hours]	Specify the maximum time for storing the recording. Default: 0 hours
Custom Path	Optionally specify a storage location for the recorded files that is relative to the root folder. This location bypasses the location specified as the root folder in the Settings > General screen.
Record to S3 Parameters	

Configuring NDI Streams

Adding an NDI Input to Zixi Broadcaster

File Name Template	<p>Specify the file name pattern that Zixi will use to generate when saving the recorded content. A separate file will be generated for each recording up to the time specified in the Max recorded file duration parameter (see above). After this duration a new file will be generated.</p> <p>The file name pattern can include any string and up to five variables listed below. Only the %T=HH.MM.SS creation time is mandatory. You can change the order of these variables and add text as long as you maintain the legitimate structure of the file in Linux and Windows:</p> <ul style="list-style-type: none">• %S=stream id - optional.• %Y=year - optional• %M=month - optional• %D=day - optional• %T=HH.MM.SS creation time – mandatory• %U=YYYYmmddTHHMMSSZ UTC timestamp – optional <p>For example, the following pattern %Y_recording%T.ts will generate the following file name 2017_recording15:32:35.ts.</p>
Max recorded file duration [hours]	Specify the maximum time allotted for recording a video stream. Default: 2 hours
URL	Specify the URL of the S3 bucket.
Ignore TLS certificate errors	TLS certificate for S3 bucket might be detected as faulty if bucket name contains dot[s]. When this option is selected, Zixi Broadcaster will ignore the TLS certificate errors and transmit the stream to its destination.
Access Key	The access key that is used for accessing the S3 bucket.
Secret Key	The secret key that is used for accessing the S3 bucket.

Creating an NDI Output

Zixi Broadcaster can transcode a TS stream Input into an NDI output using Raw video and audio profiles. The NDI output is configured in the transcoding profile itself, so there is no need to create an NDI Output from the Zixi Broadcaster Outputs screen. The Raw video profile can be configured to modify the stream's resolution (i.e. upscale/downscale) and frame rates per second. When the input stream is transcoded, it becomes available to be pulled by NDI enabled devices.

➔ To Create an NDI Output:

1. Create a Raw video transcoding profile and a Raw audio transcoding profile. For instructions, see [Creating New Profiles](#) section.
2. Create an input stream by following the instructions in the **Adding Input Streams** section.
3. Click  button on the right end of the input stream row and then **Transcode**. The **Transcode <input stream name>** window with the settings of the selected input stream is displayed.
4. Enter the unique **Stream ID**, which will correspond to the new transcoded input that will be added.
5. Under **Stream Parameters**, in the **Output Type** field, select **NDI**.

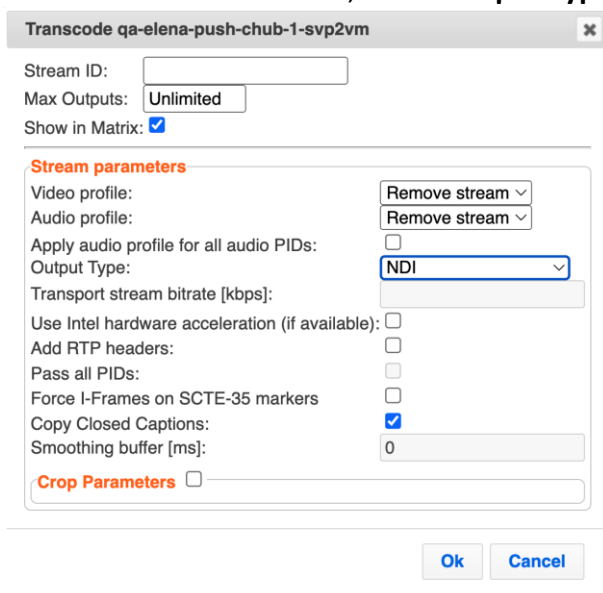

6. Under Stream Parameters, in the **Video profile** and **Audio profile** fields, do one of the following:
 - Select the Raw Video profile and Raw Audio Profile that you have configured.
 - Select **Remove stream** – you can use the transcoder to remove the video or audio track from the stream.
7. Fill in additional fields (see table below for additional parameters).

Configuring NDI Streams

Creating an NDI Output

- Click **OK**. The transcoded input stream is created and appears in an embedded window labeled Transcoded sources under the original input stream from which it was created.

	Description
Video Profile	Select an existing Raw Video profile, or select Remove stream if you want to remove the video track.
Audio Profile	Select an existing Raw Audio profile, or select Remove stream if you want to remove the audio track.
Apply audio profile for all audio PIDs	Select this checkbox to apply the selected audio profile for all PIDs.
Output Type	Select NDI – the output will be available as NDI. When selecting NDI output, you can select the following video/audio profiles: <ul style="list-style-type: none">• Video profile – remove stream or a Raw profile.• Audio profile - remove stream or a Raw profile.
Transport stream bitrate [kbps]	Specify the bitrate of the transport stream. This parameter is optional. If you do not specify a TS Bitrate, the stream will be VBR. If you specify a bitrate, the stream will be CBR. The bitrate value must be compatible with the selected profile.
Use Intel Hardware Acceleration (if available)	Select this checkbox to use hardware acceleration component if it has been installed. When using an Nvidia profile, this setting will be disabled.
Add RTP headers	Select this checkbox to add RTP headers to the stream. RTP adds a 12-byte header, which includes a sequence number and a timestamp that can be used to detect dropped packets. The sequence number in the RTP headers can be used to do automatic reordering and the timestamps can help overcome inter-packet gaps, also known as IAT (Inter Arrival Time). However, plain RTP does not feature error recovery or error protection. By default, the RTP headers (which include the timestamps and sequences) are being used on the input side, but then they are stripped off and they no longer propagate to outputs.
Pass all PIDs	Select this checkbox to pass-through all non-transcoded PIDs.
Force I-Frames on SCTE-35 markers	
Copy Closed Captions	Default selected.

Configuring NDI Streams

Creating an NDI Output

Smoothing buffer [ms]	The Smoothing feature uses a buffer to time packets according to the stream's clock. This is useful when there are bursts in the rate in which the stream arrives. The smoothing feature creates a queue in the buffer, allowing smoother entry into the Broadcaster. The Smoothing parameter defines the size of the buffer in Milliseconds. A larger the buffer enables smoother entry. However, it may influence the latency rate.
Crop Parameters	Select this checkbox to set the cropping parameters.
Cropping Mode	Set the units used for defining the crop. Options are: <i>Pixels</i> or <i>Percentages</i> . Note: Depending on the type of content, in some cases using different crop values for low resolution outputs might be appropriate. For example, if the content includes both video content and textual content, the text would not be readable at lower resolutions and thus might be better to exclude. Another use case for using different crop values for each output would be to slice a 360 or VR input video.
Left, Top	Specify the left and top positions for the crop.
Width x Height	Specify the width and height values for the crop.
Enable time shift	
Maximum delay [hh:mm:ss]	Specify the time of the delayed transmission of this stream. Maximum: 24 hours.
Transmit as multicast	Selecting this checkbox enables the transmission of this stream's outputs as multicast. A Zixi receiver that will pull the stream will receive it in multicast. By default, Zixi Broadcaster is configured to allow transparent fallback to unicast if it is out of the LAN. Requires enabling Multicast Pull in the Settings. This setting requires enabling Multicast Pool (Settings > Multicast Pool).
Multicast Only	Selecting this checkbox will force the transmission of this stream only in multicast.
Enable Encryption	Select this checkbox to encrypt the Input stream. For more information, see Encrypting an Input Stream in Zixi Broadcaster .
Encryption type (for Encryption enabled)	Specify the type of Encryption (AES 128/192/256).
Encryption key (for encryption enabled)	Click Generate to generate an encryption key. The generated encryption key must be sent to the end-user to decipher the received encoded stream.
Recording parameters	Select this checkbox to customize the recording parameters.

Configuring NDI Streams

Creating an NDI Output

Destination Type	Select the radio button for the desired storage type and then fill in the relevant parameters. <ul style="list-style-type: none">• Record to disk – the recording is saved on the local disk.• Record to S3 – the file is saved to your AWS S3 Bucket.
Record to Disk Parameters	
File Name Template	Specify the file name pattern that Zixi will use to generate when saving the recorded content. A separate file will be generated for each recording up to the time specified in the Max recorded file duration parameter (see above). After this duration a new file will be generated. The file name pattern can include any string and up to five variables listed below. Only the %T=HH.MM.SS creation time is mandatory. You can change the order of these variables and add text as long as you maintain the legitimate structure of the file in Linux and Windows: <ul style="list-style-type: none">• %S=stream id - optional.• %Y=year - optional• %M=month - optional• %D=day - optional• %T=HH.MM.SS creation time - mandatory For example, the following pattern %Y_recording%T.ts will generate the following file name 2017_recording15:32:35.ts.
Max recorded file duration [hours]	Specify the maximum time allotted for recording a video stream. Default: 2 hours
Keep recorded files for [hours]	Specify the maximum time for storing the recording. Default: 0 hours
Custom Path	Optionally specify a storage location for the recorded files that is relative to the root folder. This location bypasses the location specified as the root folder in the Settings > General screen.
Record to S3 Parameters	

Configuring NDI Streams

Creating an NDI Output

File Name Template	<p>Specify the file name pattern that Zixi will use to generate when saving the recorded content. A separate file will be generated for each recording up to the time specified in the Max recorded file duration parameter (see above). After this duration a new file will be generated.</p> <p>The file name pattern can include any string and up to five variables listed below. Only the %T=HH.MM.SS creation time is mandatory. You can change the order of these variables and add text as long as you maintain the legitimate structure of the file in Linux and Windows:</p> <ul style="list-style-type: none">• %S=stream id - optional.• %Y=year - optional• %M=month - optional• %D=day - optional• %T=HH.MM.SS creation time - mandatory <p>For example, the following pattern %Y_recording%T.ts will generate the following file name 2017_recording15:32:35.ts.</p>
Max recorded file duration [hours]	Specify the maximum time allotted for recording a video stream. Default: 2 hours
URL	Specify the URL of the S3 bucket.
Ignore TLS certificate errors	TLS certificate for S3 bucket might be detected as faulty if bucket name contains dot[s]. When this option is selected, Zixi Broadcaster will ignore the TLS certificate errors and transmit the stream to its destination.
Access Key	The access key that is used for accessing the S3 bucket.
Secret Key	The secret key that is used for accessing the S3 bucket.

Configuring WebRTC Streams

Zixi supports using WebRTC to monitor streams. With WebRTC you can monitor your streams using popular browsers, such as Chrome, without installing any external plugins, such as the Zixi VLC plugin. This guide describes the process of transcoding a stream to support WebRTC and how to monitor a stream using the WebRTC browser-integrated player.

Video and Audio Codec Support Options

WebRTC stream delivery requires particular audio and video codecs. In case the streams you are transporting via Zixi Broadcaster do not match these requirements, additional transcoding will be necessary in order to re-encode the stream to become WebRTC compliant.

The following are the requirements for a Zixi stream to be *WebRTC compliant*:

- **Video** - H.264 codec with Baseline or Main profile and no B frames
- **Audio** – Opus codec

The following is a description of the possible methods for processing streams in Zixi for WebRTC viewing:

- **Pass-Through** – if the stream is already fully compliant with WebRTC, then it can be passed through the Zixi Broadcaster to the WebRTC player for viewing.
- **Transcoding** – if the incoming stream is not fully compliant, then you need to first transcode the stream in order to prepare it for delivery to the WebRTC player. There are two methods that can be used for transcoding a stream for WebRTC.
 - **Single Version - Creating a single version of the monitor stream for all users** – in this option the stream will be encoded using Zixi Broadcaster's transcoder (with existing X264 or Nvidia for transcoding). This option allows many users to monitor the stream without encoding for each individual user, which saves CPU capacity. However, the option will still require additional output bandwidth for each user. Since there is only one stream version, it is recommended to encode to a low resolution and low bitrate so that the stream will be viewable by all users monitoring the stream.
 - **Multiple Version - Creating a unique version of the monitor stream for each user** – in this option Zixi Broadcaster will transcode the video, transforming it into RAW frames, which will be passed to the WebRTC library, where it will be re-encoded for each individual user. In this option the stream will match the bitrate available for every particular user. Although this promises the best quality for users' specific network conditions, each re-encode consumes CPU, which

Configuring WebRTC Streams

Video and Audio Codec Support Options

could potentially max out the available CPU resources used to transport the streams. In this case, if the stream will be monitored by a large number of users, it is recommended to host a second Broadcaster and send the stream to the second Broadcaster and have all users monitor the stream from that second Broadcaster. By doing so, there will be no impact on the primary Broadcaster.

Input Codec	Passthrough	Single Version	Multiple Version
Video Codecs			
H.264 with no B-frames (profile Baseline/Main)	Yes	Not Relevant	Not Relevant
H.264 with B-frames	No	Transcode to WebRTC compliant profile (e.g. H.264 codec with Baseline or Main profile and no B frames). Needs transcoding on a server with Nvidia GPUs.	Transcode to a RAW profile and specify a low resolution.
MPEG2	No	Transcode to WebRTC compliant profile. Needs transcoding on a server with Nvidia GPUs.	Transcode to a RAW profile and specify a low resolution.
HEVC	No	Transcode to WebRTC compliant profile. Needs transcoding on a server with Nvidia GPUs.	Transcode to a RAW profile and specify a low resolution.
Audio Codecs			
Opus	Yes	Not Relevant	Not Relevant
AAC	No	Transcode to Opus codec.	Transcode to RAW.
AC-3LC / HE v1 / HE v2	No	Transcode to Opus codec.	Transcode to RAW.
MPEG-2 Audio Layer II	No	Transcode to Opus codec.	Transcode to RAW.

Configuring WebRTC Streams

Video and Audio Codec Support Options

MPEG-1 Audio Layer II	No	Transcode to Opus codec.	Transcode to RAW.
E-AC-3 (and other unsupported codecs)	Not supported. The stream will be passed through to WebRTC without audio.	Not relevant	Not relevant

Creating Transcoding Profiles for WebRTC

In order to enable transcoding of non-WebRTC compliant streams you need to first create the relevant Transcoding Profiles. You need to create separate video and audio profiles for use with Single Version and Multiple Version transcoding methods. You will then be able to apply those profiles to your streams as needed.



Transcoding is not currently supported in ARM builds of Zixi Broadcaster.

Creating a Video Profile for “Single Version” Transcoding

➔ **To create a video profile for “Single Version” transcoding:**

1. On the **Transcoder** screen of the Broadcaster UI, click **New Profile**. The Add New Profile window opens.

2. Under **Codec type**, select the **H.264** radio button (default).
3. In the **Name** field, enter a name that describes this profile (e.g. WebRTCSingleVersionVideo)
4. In the **Encoding Profile** field, select either *Baseline* or *Main*.
5. In the **Resolution** fields, enter a low resolution that can be viewed by all of your users.
6. Configure additional parameters as required, see [Creating New Profiles](#).
7. Click **Apply**.
The new profile is created and it can be used to configure a “Single Version” WebRTC output.

Creating an Audio Profile for “Single Version” Transcoding

➔ **To create an audio profile for “Single Version” transcoding:**

1. On the **Transcoder** screen of the Broadcaster UI, click **New Profile**. The **Add New Profile** window opens.

Configuring WebRTC Streams

Creating Transcoding Profiles for WebRTC

2. Under **Codec type**, select the **Opus** radio button (default).
The Opus configuration options are shown.

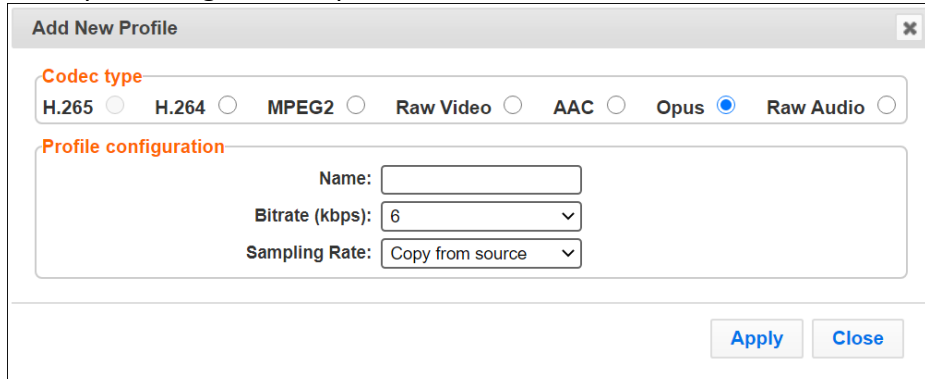

The screenshot shows the 'Add New Profile' dialog box. Under the 'Codec type' section, the 'Opus' radio button is selected. The 'Profile configuration' section contains three fields: 'Name' (a text input field), 'Bitrate (kbps)' (a dropdown menu with '6' selected), and 'Sampling Rate' (a dropdown menu with 'Copy from source' selected). At the bottom right, there are 'Apply' and 'Close' buttons.

3. In the **Name** field, enter a name that describes this profile (e.g. WebRTCSingleVersionAudio)
4. Configure additional parameters as required, see [Creating New Profiles](#).
5. Click **Apply**.
The new profile is created and it can be used to configure a “Single Version” WebRTC output.

Creating a Video Profile for “Multiple Version” Transcoding

➔ To create a video profile for “Multiple Version” transcoding:

1. On the **Transcoder** screen of the Broadcaster UI, click **New Profile**.
The **Add New Profile** window opens.
2. Under **Codec type**, select **Raw Video** (default).
The Raw Video configuration options are shown.

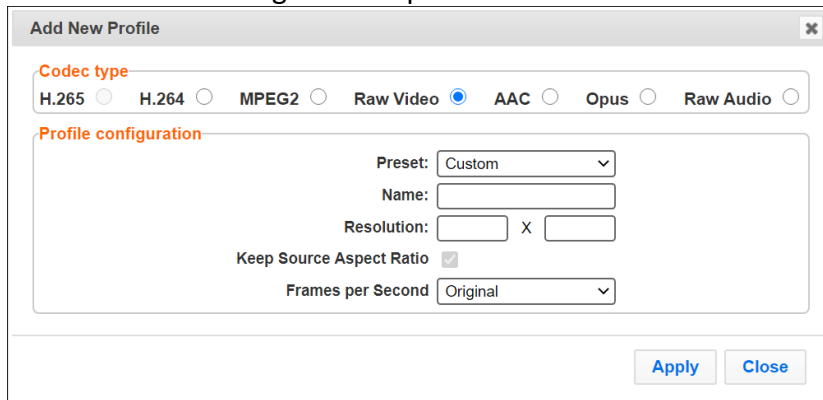

The screenshot shows the 'Add New Profile' dialog box. Under the 'Codec type' section, the 'Raw Video' radio button is selected. The 'Profile configuration' section contains five fields: 'Preset' (a dropdown menu with 'Custom' selected), 'Name' (a text input field), 'Resolution' (two text input fields separated by an 'X'), 'Keep Source Aspect Ratio' (a checked checkbox), and 'Frames per Second' (a dropdown menu with 'Original' selected). At the bottom right, there are 'Apply' and 'Close' buttons.

3. In the **Name** field, enter a name that describes this profile (e.g. WebRTCMultipleVersionVideo)
4. Configure additional parameters as required, see [Creating New Profiles](#).
5. Click **Apply**.
The new profile is created and it can be used to configure a “Multiple Version” WebRTC output.

Creating an Audio Profile for “Multiple Version” Transcoding

➔ To create an audio profile for “Multiple Version” transcoding:

1. On the **Transcoder** screen of the Broadcaster UI, click **New Profile**.
The Add New Profile window opens.
2. Under **Codec type**, select **Raw Audio** (default).
The Raw Audio configuration options are shown.

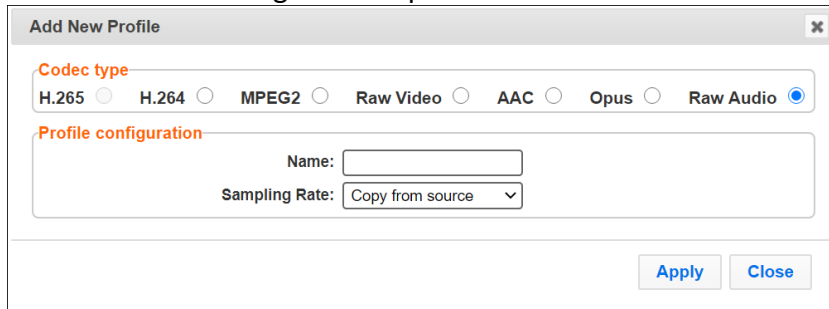

3. In the **Name** field, enter a name that describes this profile (e.g. WebRTCMultipleVersionAudio)
4. Configure additional parameters as required, see [Creating New Profiles](#).
5. Click **Apply**.
The new profile is created and it can be used to configure a “Multiple Version” WebRTC output.

Creating a WebRTC Output

Zixi Broadcaster can transcode a TS stream Input into a WebRTC output using the relevant profiles, depending on the input video and audio, as described in the [Video and Audio Codec Support Options](#) section. Before creating the WebRTC output, make sure you have configured the relevant transcoding profiles [Creating Transcoding Profiles for WebRTC](#).

When the input stream is transcoded, it becomes available to be pulled by the WebRTC player.

➔ To Create a WebRTC Output:

1. Create an input stream by following the instructions in the [Adding Input Streams](#) section of the Broadcaster UG.
2. Click  button on the right end of the input stream row, and then click **Transcode**.
The **Transcode <input stream name>** window with the settings of the selected input stream is displayed.
3. Enter the unique **Stream ID**, which will correspond to the new transcoded input that will be added.

Creating a WebRTC Output

4. In the **Output Type** field, select **WebRTC**.

Transcode webrtc test

Stream ID:

Max Outputs:

Show in Matrix:

Stream parameters

Video profile:

Audio profile:

Output Type:

Transport stream bitrate [kbps]:

Use Intel hardware acceleration (if available):

Pass all PIDs:

Smoothing buffer [ms]:

Crop Parameters

Enable time shift

Transmit as multicast

Enable encryption

Recording parameters

Ok Cancel

5. Under **Stream Parameters**, in the **Video profile** field, select the desired video profile for the desired method.
 - a. Pass-Through – select **Keep original stream**
 - b. Single Version Transcoding – select a profile that converts to H.264 with Main or Baseline profile and no B Frames
 - c. Multiple Version Transcoding – select a profile that converts to RAW video
6. In the **Audio profile** field, select the desired audio profile for the desired method.
 - d. Pass-Through – select **Keep original stream**
 - e. Single Version Transcoding – select a profile that converts to Opus
 - f. Multiple Version Transcoding – select a profile that converts to RAW audio



Only supported profiles are shown. If you would like to remove the video or audio stream completely, select **Remove stream**.

7. Configure additional parameters as required, see [Transcoding an Input Stream](#).
8. Click **OK**. The transcoded input stream is created and appears in an embedded window labeled Transcoded sources under the original input stream from which it was created.

Playing and input stream with WebRTC player

WebRTC uses a regular browser to play the stream without the need to download and install an external plug in.

➔ To Play Input Streams with WebRTC:

1. In the Zixi Broadcaster **Inputs** page, click the desired WebRTC input stream that you want to play.
2. Click the  button on the right end of the selected row and then **Play WebRTC**. The **Link Description** window will open with the directory path for the desired file and a link to open a browser window to play the stream.

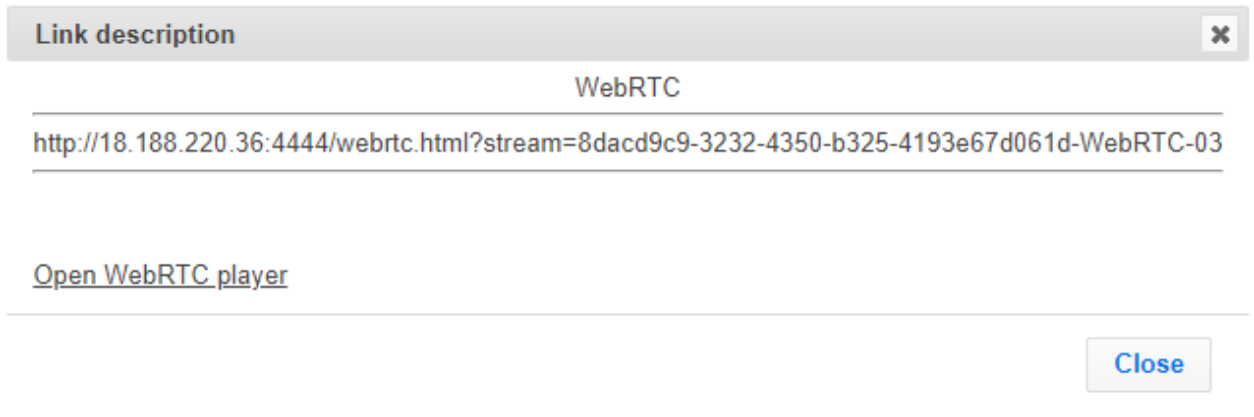

3. Copy the link or click the **Open WebRTC player** link to view the stream.

Configuring MultiPath TCP

Developed by the Internet Engineering Task Force's (IETF) Multipath TCP working group, MultiPath TCP (MPTCP) is an effort towards enabling the simultaneous use of several IP-addresses/interfaces by a modification of TCP that presents a regular TCP interface to applications, while in fact spreading data across several subflows. This means that the Linux Kernel should be updated to support MPTCP.

The MPTCP functionality is similar to Zixi's "multi-link bonding" feature, which is available for UDP only, while MPTCP works on TCP.

If both the sending end and the receiving end support MultiPath TCP, Zixi can use this functionality to transmit a stream over TCP using multiple network interfaces (e.g. Wifi + mobile). The multiple links can be configured to:

- **Aggregate** - aggregates the bandwidth of the multiple links in order to use the total capacity of these links. In this case Zixi will use all available bandwidth among all available flows (if needed) to send the stream.
- **Duplicate** - enhance the path's resiliency by duplicating the stream and sending through all links in order to overcome errors and packet loss.

MultiPath Modes

MultiPath TCP can be used in two modes:

- **Pull** – when pulling the stream, the receiving-end has multiple network interfaces (e.g. two NIC) while the sending side has one network interface. When the stream is pulled by the receiving-end using the MultiPath feature, the client (receiving side / puller) creates the sub-flows, (one per nic) and connects to the "source" (the server). The definition of the NICs in the destination is done automatically at the OS socket level. To configure this mode:
 - **In the sending side** - In **Settings > Live Protocols** screen, enable the **Allow automatic Pull output option**. In this option the output will be created automatically when the Pull connection is established. Following the connection, the two links will be displayed as bonded links. When the connection is established, the two links will be displayed as bonded links as shown below.

Configuring MultiPath TCP

MultiPath Modes

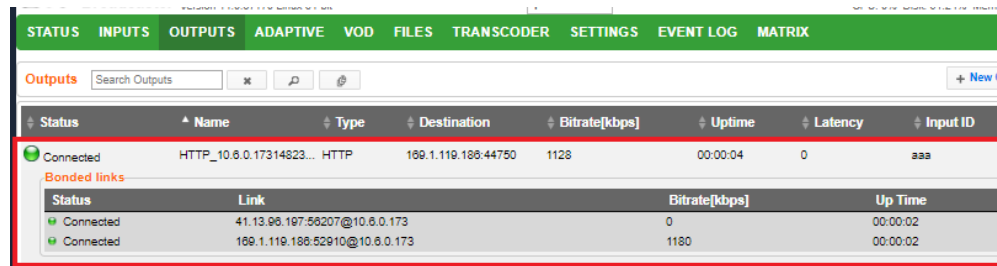

Status	Name	Type	Destination	Bitrate[kbps]	Uptime	Latency	Input ID
Connected	HTTP_10.6.0.17314823...	HTTP	169.1.119.188:44750	1128	00:00:04	0	aaa

Status	Link	Bitrate[kbps]	Up Time
Connected	41.13.96.197:56207@10.6.0.173	0	00:00:02
Connected	169.1.119.188:52910@10.6.0.173	1180	00:00:02

- In the receiving side – Configure a **TS over HTTP Input as Pull**. When the connection is established, only one link is displayed as shown below.

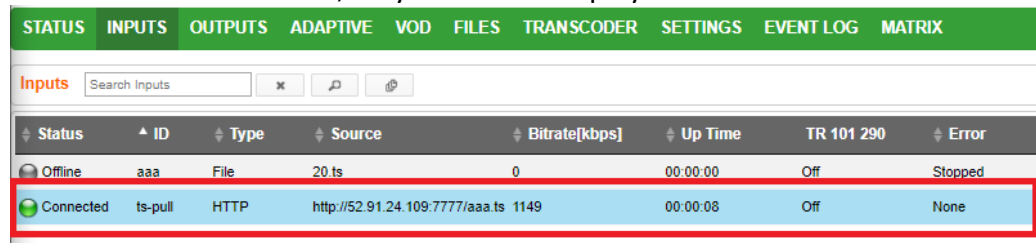

Status	ID	Type	Source	Bitrate[kbps]	Up Time	TR 101 290	Error
Offline	aaa	File	20.ts	0	00:00:00	Off	Stopped
Connected	ts-pull	HTTP	http://52.91.24.109:7777/aaa.ts	1149	00:00:08	Off	None

- **Push** – when pushing the stream, the receiving-end has one or more network interfaces (e.g. two NICs) while the sending side can have one network interface. In this case, you should configure it in the following way:

- In the sending side – you will need to configure a **TCP output** from the Zixi Broadcaster in the sending side. In this case you can configure the two links as **Aggregate** or **Duplicate**, as described above. When the connection is established, the two links will be displayed as bonded links as shown below.

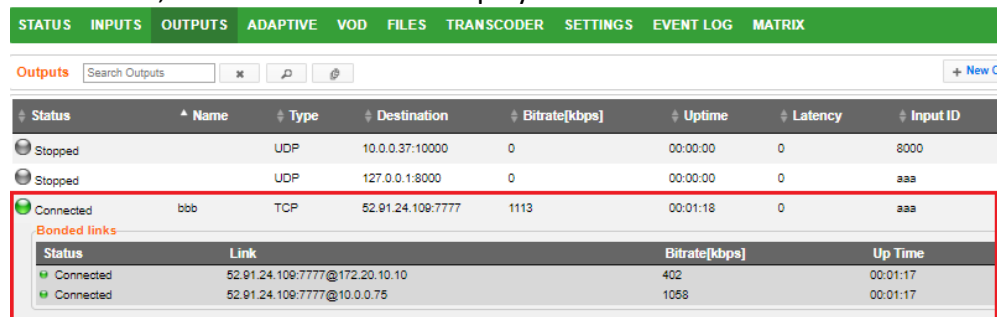

Status	Name	Type	Destination	Bitrate[kbps]	Uptime	Latency	Input ID
Stopped		UDP	10.0.0.37:10000	0	00:00:00	0	8000
Stopped		UDP	127.0.0.1:8000	0	00:00:00	0	aaa
Connected	bbb	TCP	52.91.24.109:7777	1113	00:01:18	0	aaa

Status	Link	Bitrate[kbps]	Up Time
Connected	52.91.24.109:7777@172.20.10.10	402	00:01:17
Connected	52.91.24.109:7777@10.0.0.75	1058	00:01:17

- In the receiving side - In the receiving-end, if this is also a Zixi Broadcaster, you have two options:
 - Configure a **TS over HTTP Input as Push**. In this option the Push input is ready in advance and will show the bitrates of both TCP connections when the connection has been established.
 - In **Settings > Live Protocols** screen, enable the **Allow automatic Push input option**. In this option the input will be created automatically when the Push connection is established. When the connection is established, the two links will be displayed as bonded links as shown below.

Configuring MultiPath TCP

MultiPath TCP Setup

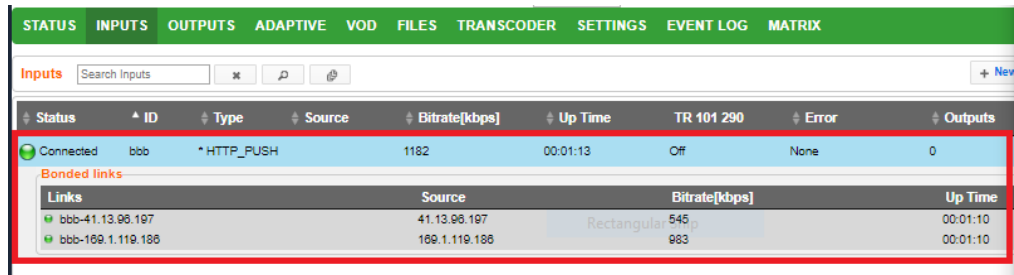

Status	ID	Type	Source	Bitrate[kbps]	Up Time	TR 101 290	Error	Outputs
Connected	bbb	* HTTP_PUSH		1182	00:01:13	Off	None	0

Bonded links

Links	Source	Bitrate[kbps]	Up Time
bbb-41.13.98.197	41.13.98.197	545	00:01:10
bbb-109.1.119.188	109.1.119.188	983	00:01:10

MultiPath TCP Setup

Zixi supports MultiPath TCP for Linux based on the OS Kernel support. This means that the Linux Kernel should be updated to support MPTCP.

➔ To setup MultiPath TCP:

- Follow the relevant instructions in - <https://multipath-tcp.org/pmwiki.php/Users/HowToInstallMPTCP?>

Using an External Storage

Modification of location of the Zixi Broadcasters 'cache' directory may be desired to minimize HDD used at the default location for recording streams. The default storage location (C:\Program Files\Zixi\Broadcaster\cache) can be replaced by using a symbolic link.



The Zixi Broadcaster will need to be in in a Maintenance Window to apply these steps as the service will be turned off and on.

➔ To configure an external storage path in windows:

1. On the Zixi Broadcaster Windows machine, stop the Zixi Broadcaster service, by going into the operating system **Services** screen.
2. Double click the Zixi Broadcaster service to open its configuration properties.
3. Under the **General** tab, in the **Startup type** drop-down menu, select the **Manual** option.
4. Click the **Stop** button and then click **OK**.

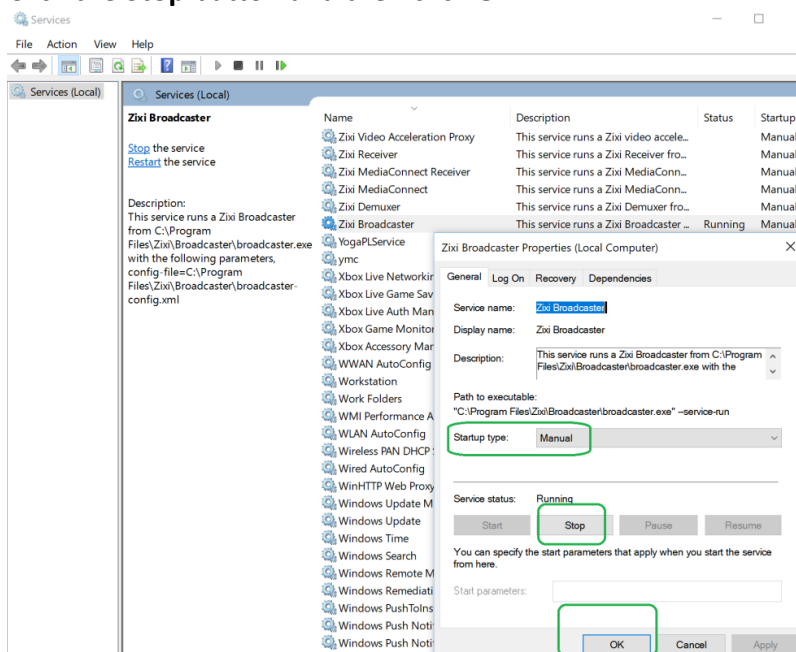

5. Delete the 'cache' file located at C:\Program Files\Zixi\Broadcaster\cache. This may require Administrator privileges depending on your environment.
6. On the planned new location create your new cache directory. In the example below the directory was created in d:_Zixi\Bx\cache.

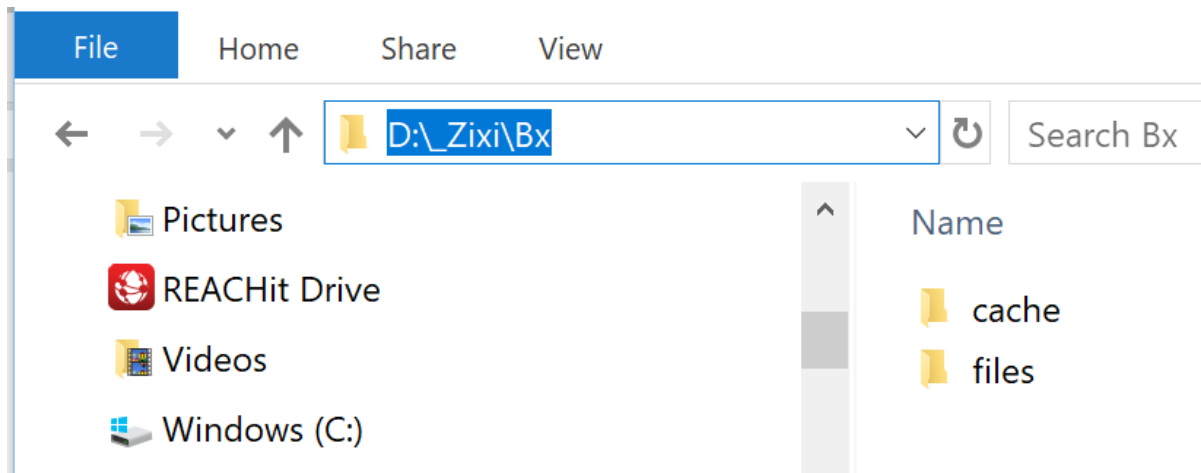

7. Go into the Windows Command line (cmd) as an Administrator.
8. Enter a makelink command to create a new Symbolic link from the original path to the newly created 'cache' folder. For example:

```
mklink /D "c:\Program Files\Zixi\Broadcaster\cache" d:\_Zixi\Bx\cache
```

```
Administrator: Command Prompt
Microsoft Windows [Version 10.0.17134.885]
(c) 2018 Microsoft Corporation. All rights reserved.

C:\WINDOWS\system32>mklink /D "c:\Program Files\Zixi\Broadcaster\cache" d:\_Zixi\Bx\cache
symbolic link created for c:\Program Files\Zixi\Broadcaster\cache <==> d:\_Zixi\Bx\cache

C:\WINDOWS\system32>
```

The newly created symbolic link for cache will be displayed in the following directory -
C:\Program Files\Zixi\Broadcaster\

9. Go into the operating system **Services** screen.
10. Double click the Zixi Broadcaster service to open its configuration properties.
11. Under the **General** tab, in the **Startup type** drop-down menu, select the Automatic option.
12. Click the **Start** button and then click **OK**.

The recording of input streams will be stored in the new directory.

- License for OpenSSL

This product includes software developed by the OpenSSL Project for use in the OpenSSL Toolkit

(<http://www.openssl.org/>)

THIS SOFTWARE IS PROVIDED BY THE OpenSSL PROJECT ``AS IS'' AND ANY EXPRESSED OR IMPLIED WARRANTIES, INCLUDING, BUT NOT LIMITED TO, THE IMPLIED WARRANTIES OF MERCHANTABILITY AND FITNESS FOR A PARTICULAR PURPOSE ARE DISCLAIMED. IN NO EVENT SHALL THE OpenSSL PROJECT OR ITS CONTRIBUTORS BE LIABLE FOR ANY DIRECT, INDIRECT, INCIDENTAL, SPECIAL, EXEMPLARY, OR CONSEQUENTIAL DAMAGES (INCLUDING, BUT NOT LIMITED TO, PROCUREMENT OF SUBSTITUTE GOODS OR SERVICES; LOSS OF USE, DATA, OR PROFITS; OR BUSINESS INTERRUPTION) HOWEVER CAUSED AND ON ANY THEORY OF LIABILITY, WHETHER IN CONTRACT, STRICT LIABILITY, OR TORT (INCLUDING NEGLIGENCE OR OTHERWISE) ARISING IN ANY WAY OUT OF THE USE OF THIS SOFTWARE, EVEN IF ADVISED OF THE POSSIBILITY OF SUCH DAMAGE.

This product includes cryptographic software written by Eric Young (eay@cryptsoft.com). This product includes software written by Tim

Hudson (tjh@cryptsoft.com).

Copyright (c) 1998-2017 The OpenSSL Project. All rights reserved.

- License for Libssh2

Copyright (c) 2004-2007 Sara Golemon <sarag@libssh2.org>

Copyright (c) 2005,2006 Mikhail Gusarov <dottedmag@dottedmag.net>

Copyright (c) 2006-2007 The Written Word, Inc.

Copyright (c) 2007 Eli Fant <elifantu@mail.ru>

Copyright (c) 2009-2014 Daniel Stenberg

Copyright (C) 2008, 2009 Simon Josefsson

All rights reserved.

Redistribution and use in source and binary forms, with or without modification, are permitted provided that the following conditions are met: Redistributions of source code must retain the above copyright notice, this list of conditions and the following disclaimer. Redistributions in binary form must reproduce the above copyright notice, this list of conditions and the following disclaimer in the documentation and/or other materials provided with the distribution.

Neither the name of the copyright holder nor the names of any other contributors may be used to endorse or promote products derived from this software without specific prior written permission.

THIS SOFTWARE IS PROVIDED BY THE COPYRIGHT HOLDERS AND CONTRIBUTORS "AS IS" AND ANY EXPRESS OR IMPLIED WARRANTIES, INCLUDING, BUT NOT LIMITED TO, THE IMPLIED WARRANTIES OF MERCHANTABILITY AND FITNESS FOR A PARTICULAR PURPOSE ARE DISCLAIMED. IN NO EVENT SHALL THE COPYRIGHT OWNER OR CONTRIBUTORS BE LIABLE FOR ANY DIRECT, INDIRECT, INCIDENTAL, SPECIAL, EXEMPLARY, OR CONSEQUENTIAL DAMAGES (INCLUDING, BUT NOT LIMITED TO, PROCUREMENT OF SUBSTITUTE GOODS OR SERVICES; LOSS OF USE, DATA, OR PROFITS; OR BUSINESS INTERRUPTION) HOWEVER CAUSED AND ON ANY THEORY OF LIABILITY, WHETHER IN CONTRACT, STRICT LIABILITY, OR TORT (INCLUDING NEGLIGENCE OR OTHERWISE) ARISING IN ANY WAY OUT OF THE USE OF THIS SOFTWARE, EVEN IF ADVISED OF THE POSSIBILITY OF SUCH DAMAGE.

- License for DekTec's Linux SDK. Version 1, August 2012

Copyright (C) 2000-2015 DekTec Digital Video B.V.

Redistribution and use in source and binary forms, with or without modification, are permitted provided that the following conditions are met:

1. Redistributions of source code must retain the above copyright notice, this list of conditions and the following disclaimer.

2. Redistributions in binary format must reproduce the above copyright notice, this list of conditions and the following disclaimer in the documentation.

THIS SOFTWARE IS PROVIDED "AS IS", WITHOUT WARRANTY OF ANY KIND, EXPRESS OR IMPLIED, INCLUDING BUT NOT LIMITED TO WARRANTIES OF MERCHANTABILITY, FITNESS FOR A PARTICULAR PURPOSE AND NONINFRINGEMENT. IN NO EVENT SHALL DEKTEC DIGITAL VIDEO BV, ITS AGENTS OR ITS EMPLOYEES BE LIABLE FOR ANY DIRECT, INDIRECT, CONSEQUENTIAL, INCIDENTAL, OR OTHER DAMAGES (INCLUDING DAMAGES FOR THE LOSS OF USE, INFORMATION, GOODWILL, PROFIT, WORK STOPPAGE, DATA, BUSINESS OR REVENUE) UNDER ANY CIRCUMSTANCES, OR UNDER ANY LEGAL THEORY, WHETHER IN CONTRACT, IN TORT, IN NEGLIGENCE, OR OTHERWISE, ARISING FROM THE USE OF, OR INABILITY TO USE THIS SOFTWARE, EVEN IF ADVISED OF THE POSSIBILITY OF SUCH DAMAGES.